

training tables

 3 Days and  15 Lead Time

Product Specifications

- 1" thick tops only, 2mm PVC edge-banding, pilot holes for post leg brackets only and metal inserts for ganging brackets.
- Maverick Series has radiused corners, Arroyo Series has square corners.
- Available in 20 standard colors, see color chart for upcharge information. Two colors may be specified at no charge.
- No up-charge for contrasting color edge-banding.
- Legs and ganging hardware are ordered separately from the tops and are not factory installed.
- All training and height adjustable tables can be assembled upon request at no charge.
- Tops are predrilled for leg/base where specified on leg/base style items.

How to Order Training Tables

WORKSURFACE UNITS

1. Product number: **MM TR 24 60**

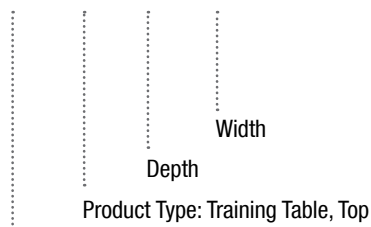

- Specify worksurface color - Choose from 20 standard colors.
- Specify edge-banding color - Matching top color is standard.
- Specify other accessories and upgrades. Grommet options on page 120. See grommet locations below.
- Legs are ordered separately. Specify from available legs on pages 116–119.
- Ganging and connecting hardware is ordered separately. See page 120.

MAVERICK SERIES (MM)

EDGE PROFILE-RADIUS

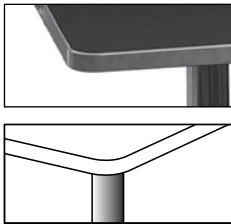

2MM FLAT PVC EDGE BANDING ON TOPS

ARROYO SERIES (AR)

EDGE PROFILE-SQUARE

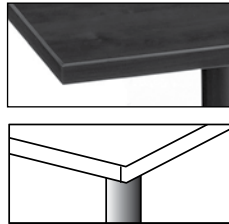

2MM FLAT PVC EDGE BANDING ON TOPS

GROMMET OPTIONS

BLACK AND SILVER



TRAINING TABLE TOP STANDARD GROMMET LOCATIONS (Unless otherwise specified)

Note: While sitting at unit, grommet locations are named from left to right. Line drawings shown below are standard locations.

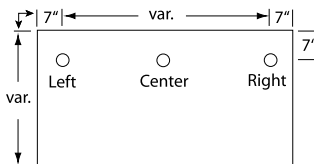

Rectangular
24" or 30"

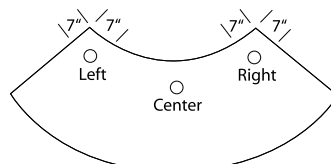

Curved
24" or 30"

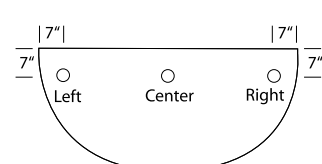

Half-Round
48" or 60"

training tables

Training Worksurfaces

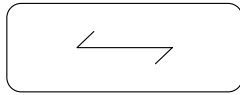
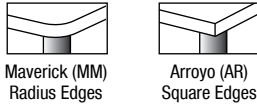

Maverick

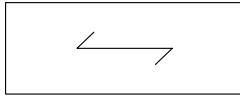

Arroyo

Rectangular Training Table Top, 20"D Tops (MM radius edges, AR square edges)

Model#	Depth	Width	Height	Weight	Cube	MM Price	AR Price
__TR2036	20"	36"	1"	23	1	\$282	\$251
__TR2042	20"	42"	1"	27	1	\$287	\$257
__TR2048	20"	48"	1"	30	1	\$301	\$272
__TR2054	20"	54"	1"	34	1	\$318	\$288
__TR2060	20"	60"	1"	38	1	\$364	\$328
__TR2066	20"	66"	1"	42	1	\$386	\$349
__TR2072*	20"	72"	1"	45	1	\$417	\$380
__TR2078*	20"	78"	1"	49	1	\$477	\$432
__TR2084*	20"	84"	1"	53	1	\$523	\$470

Note: When ordering, insert MM for Maverick Series or AR for Arroyo Series. Wood grain runs the width direction.

*Tops: 72"W, 78"W & 84"W requires 5 post legs.

Stabilizer Bar: 2 are included with 60"W, 66"W & 72"W tops, when ordered with post legs.

Max weight 50 lbs.

Pre Drilled Holes: Tops are pre-drilled for 4 post legs MMLEGTRB – MMLEGTRSC.

Ganging Hardware: Is recommended when placing tops side by side.  Lead Time.

Rectangular Training Table Top, 24"D Tops (MM radius edges, AR square edges)

Model#	Depth	Width	Height	Weight	Cube	MM Price	AR Price
__TR2436	24"	36"	1"	30	1	\$380	\$342
__TR2442	24"	42"	1"	32	1	\$392	\$355
__TR2448	24"	48"	1"	36	1	\$409	\$373
__TR2454	24"	54"	1"	40	1	\$425	\$386
__TR2460	24"	60"	1"	45	1	\$439	\$392
__TR2466	24"	66"	1"	50	1	\$463	\$417
__TR2472*	24"	72"	1"	54	1	\$477	\$432
__TR2478*	24"	78"	1"	59	1	\$523	\$470
__TR2484*	24"	84"	1"	63	1	\$554	\$499

Note: When ordering, insert MM for Maverick Series or AR for Arroyo Series. Wood grain runs the width direction.

*Tops: 72"W, 78"W & 84"W requires 5 post legs.

Stabilizer Bar: 2 are included with 60"W, 66"W & 72"W tops, when ordered with post legs.

Max weight 50 lbs.

Pre Drilled Holes: Tops are pre-drilled for 4 post legs MMLEGTRB – MMLEGTRSC.

Ganging Hardware: Is recommended when placing tops side by side.  Lead Time.

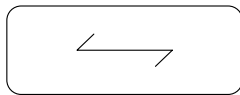

Maverick

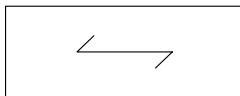

Arroyo

Rectangular Training Table Top, 30"D Tops (MM radius edges, AR square edges)

Model#	Depth	Width	Height	Weight	Cube	MM Price	AR Price
__TR3048	30"	48"	1"	45	1	\$392	\$355
__TR3054	30"	54"	1"	51	1	\$401	\$364
__TR3060	30"	60"	1"	57	1	\$440	\$392
__TR3066	30"	66"	1"	62	1	\$487	\$440
__TR3072*	30"	72"	1"	68	2	\$530	\$477
__TR3078*	30"	78"	1"	74	2	\$604	\$544
__TR3084*	30"	84"	1"	79	2	\$669	\$605

Note: When ordering, insert MM for Maverick Series or AR for Arroyo Series. Wood grain runs the width direction.

*Tops: 72"W, 78"W & 84"W requires 5 post legs.

Stabilizer Bar: 2 are included with 60"W, 66"W & 72"W tops, when ordered with post legs.

Max weight 50 lbs.

Pre-drilled Holes: Tops are pre-drilled for 4 post legs MMLEGTRB – MMLEGTRSC.

Ganging Hardware: Is recommended when placing tops side by side.  Lead Time.

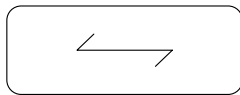

Maverick

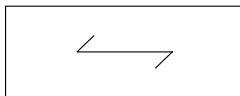

Arroyo

training tables

Training Worksurfaces

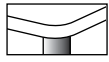

Maverick (MM)
Radius Edges

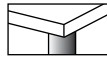

Arroyo (AR)
Square Edges

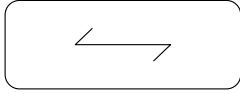

Maverick

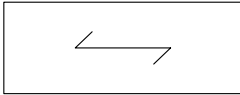

Arroyo

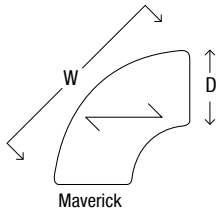

Maverick

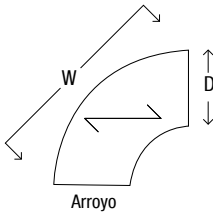

Arroyo

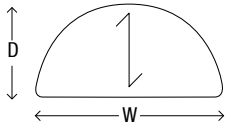

Maverick

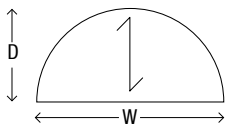

Arroyo



WG24 & WG30

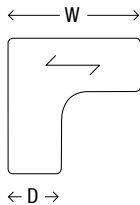

Maverick

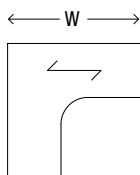

Arroyo

Rectangular Training Table Top, 36" D Tops (MM radius edges, AR square edges)

Model#	Depth	Width	Height	Weight	Cube	MM Price	AR Price
__TR3660	36"	60"	1"	68	1	\$582	\$530
__TR3666	36"	66"	1"	75	1	\$630	\$568
__TR3672*	36"	72"	1"	81	2	\$659	\$599

Note: When ordering, insert MM for Maverick Series or AR for Arroyo Series. Wood grain runs the width direction.
*Top: 72"W requires 5 post legs.

Stabilizer Bar: 2 are included with 60"W, 66"W & 72"W tops, when ordered with post legs.

Max weight 50 lbs.

Pre-drilled Holes: Tops are pre-drilled for 4 post legs MMLEGTRB – MMLEGTRSC.

Ganging Hardware: Is recommended when placing tops side by side.  Lead Time.

Curved Training Table Top (Must be ganged with another top for stability)

Model#	Depth	Width	Height	Weight	Cube	MM Price	AR Price
__TRQ2460L	24"	60"	1"	27	1	\$448	\$404
__TRQ2460R	24"	60"	1"	27	1	\$448	\$404
__TRQ3060L	30"	60"	1"	33	2	\$495	\$448
__TRQ3060R	30"	60"	1"	33	2	\$495	\$448

Note: When ordering, insert MM for Maverick Series or AR for Arroyo before model number.

On "L" units, from users' view, woodgrain direction is parallel with right edge and perpendicular with left edge.

On "R" units wood-grain is parallel with the left edge and perpendicular with the right edge.

If not ganged, order 5th leg for stability.

Pre-drilled Holes: Tops are pre-drilled for post legs MMLEGTRB – MMLEGTRS.

Ganging Hardware: Is recommended when placing tops side by side.  Lead Time.

Half-Round Training Table Top (48" & 60" require four legs and two ganging plates)

Model#	Depth	Width	Height	Weight	Cube	MM Price	AR Price
__TRWH1224	12"	24"	1"	6	1	\$224	\$178
__TRWH1224WG24	12"	24"	1"	6	1	\$224	\$178
__TRWH1530	15"	30"	1"	10	1	\$271	\$225
__TRWH1530WG30	15"	30"	1"	10	1	\$271	\$225
__TRWH2448	24"	48"	1"	24	1	\$565	\$519
__TRWH3060	30"	60"	1"	37	1	\$675	\$519

Note: When ordering, insert MM for Maverick Series or AR for Arroyo before model number.

Woodgrain direction runs the depth to coordinate with woodgrain direction on rectangular worksurfaces.

12" & 15" deep require only 1 leg and 1 ganging plate.

12" & 15" deep (WG24 & WG30), the woodgrain runs the width to coordinate with the grain on 1 end of curved units.

Pre-drilled Holes: Tops are pre-drilled for post legs MMLEGTRB – MMLEGTRS.

Ganging Hardware: Is recommended when placing tops side by side.  Lead Time.

Curved Corner Training Table Top (48" & 60" require four legs and two ganging plates)

Model#	Depth	Width	Height	Weight	Cube	MM Price	AR Price
__TRCWS424224	24"	42"/42"	1"	24	1	\$581	\$519
__TRCWS424230	30"	42"/42"	1"	24	1	\$581	\$519
__TRCWS484824	24"	48"/48"	1"	30	1	\$676	\$602
__TRCWS484830	30"	48"/48"	1"	30	1	\$676	\$676
__TRCWS606024	24"	60"/60"	1"	47	1	\$847	\$759
__TRCWS606030	30"	60"/60"	1"	47	1	\$847	\$759

Note: When ordering, insert MM for Maverick Series or AR for Arroyo before model number.

Pre-drilled Holes: Tops are pre-drilled for post legs MMLEGTRB – MMLEGTRS.

Ganging Hardware: Is recommended when placing tops side by side.  Lead Time.

training tables

Training Worksurfaces 15 DAYS

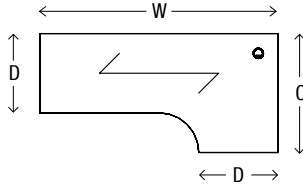
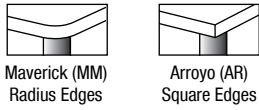

Curved Computer Training Table Top 24"D Right Connection (MM Radius Edges, AR Square Edges)

Model#	Depth	Width	Corner (c)	Height	Weight	Cube	MM Price	AR Price
__CDQ60TOP 4R	24" / 24"	60"	36"	1"	68	2	\$684	\$610
__CDQ66TOP 4R	24" / 24"	66"	36"	1"	68	2	\$722	\$647
__CDQ72TOP 4R	24" / 24"	72"	36"	1"	79	2	\$743	\$670
__CDQ72TOP 9R	30" / 24"	72"	42"	1"	79	2	\$786	\$712

Note: When ordering, Insert MM for Maverick Series or AR for Arroyo Series. Wood grain runs the width direction. Maverick series tops have three radius corners.

Pre-drilled Holes: Tops are not pre-drilled. Must order with return top. Designed for Adjustable Height L-Unit Base only.
Grommet: Standard black grommet, location 7"x7" upgrade grommet to color silver at no charge.

15 LEAD TIME

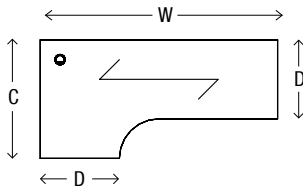

Curved Computer Training Table Top 24"D Left Connection (MM Radius Edges, AR Square Edges)

Model#	Depth	Width	Corner (c)	Height	Weight	Cube	MM Price	AR Price
__CDQ60TOP 4L	24" / 24"	60"	36"	1"	68	2	\$684	\$610
__CDQ66TOP 4L	24" / 24"	66"	36"	1"	68	2	\$722	\$647
__CDQ72TOP 4L	24" / 24"	72"	36"	1"	79	2	\$743	\$670
__CDQ72TOP 9L	24" / 30"	72"	42"	1"	79	2	\$786	\$712

Note: When ordering, Insert MM for Maverick Series or AR for Arroyo Series. Wood grain runs the width direction. Maverick series tops have three radius corners.

Pre-drilled Holes: Tops are not pre-drilled. Must order with return top. Designed for Adjustable Height L-Unit Base only.
Grommet: Standard black grommet, location 7"x7" upgrade grommet to color silver at no charge.

15 LEAD TIME

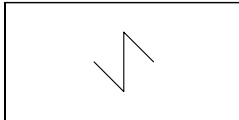

Rectangular Training Return Top, 24"D Tops (MM Radius Edges, AR Square Edges)

Model#	Depth	Width	Height	Weight	Cube	MM Price	AR Price
__TRT2436	24"	36"	1"	30	1	\$433	\$394
__TRT2442	24"	42"	1"	32	1	\$447	\$409
__TRT2448	24"	48"	1"	36	1	\$463	\$426

Note: When ordering, Insert MM for Maverick Series or AR for Arroyo Series. Return top wood grain runs vertical direction. Maverick series tops have two radius edges.

Pre-drilled Holes: Tops are not pre-drilled. Must order with computer table top. Designed for Adjustable Height L-Unit Base only.

Connecting Hardware: 2 Connecting brackets with wood screws are included.

15 LEAD TIME

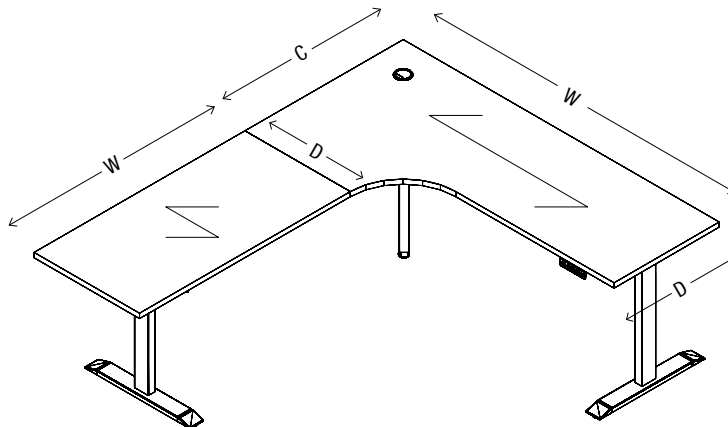

Note: Line drawings shown in square corners (AR series)

training tables

Bases, for Training Table Tops

(Leg heights vary and cannot be combined)



Post Leg 2 3/8" diameter (Set of 4 legs) for Training Table Tops

Model#	Description	Color	Weight	Cube	Height	Price
MMLEGTRB	4 Posts w/ Leveler	Black	14	1	27 13/16"	\$578
MMLEGTRS	4 Posts w/ Leveler	Brushed Steel	14	1	27 13/16"	\$578
MMLEGTRBC	4 Posts w/ Locking Casters	Black	14	1	27 15/16"	\$578
MMLEGTRSC	4 Posts w/ Locking Casters	Brushed Steel	14	1	27 15/16"	\$578
MMCULEG__	1 Individual Post Leg		14	1	27 15/16"	\$147

For individual post legs, add \$147/each. Specify complete model #MMCULEG__ (e.g. MMCULEGTRB)
 Individual post leg includes mounting screws.
 Legs are shipped un-installed and require minor assembly with woodscrews for each leg.
 Tops 72"W, 78"W & 84"W requires 5 post legs. Tops are pre-drilled for 4 post legs only.

LEAD TIME

Flip Top Base with Frame Modesty, Locking Casters (1 Complete leg)

Model#	Depth	Width	Height	Fits Top Size	Color	Weight	Cube	Price
* MMLEGFFMB48T	14/20"	40 1/4"	28 1/2"	48" & 54"W	Titanium	36	1	\$704
MMLEGFFMB48B	14/20"	40 1/4"	28 1/2"	48" & 54"W	Black	36	1	\$704
* MMLEGFFMB48W	14/20"	40 1/4"	28 1/2"	48" & 54"W	White	36	1	\$704
MMLEGFFMB60T	14/20"	52"	28 1/2"	60" & 66"W	Titanium	40	1	\$783
* MMLEGFFMB60B	14/20"	52"	28 1/2"	60" & 66"W	Black	40	1	\$783
MMLEGFFMB60W	14/20"	52"	28 1/2"	60" & 66"W	White	40	1	\$783
MMLEGFFMB72T	14/20"	63 1/4"	28 1/2"	72" & 78"W	Titanium	43	1	\$915
MMLEGFFMB72B	14/20"	63 1/4"	28 1/2"	72" & 78"W	Black	43	1	\$915
MMLEGFFMB72W	14/20"	63 1/4"	28 1/2"	72" & 78"W	White	43	1	\$915

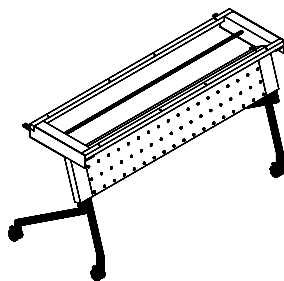

For rectangular tops 20"D & 24"D only, see page 113.

*Note: Color Titanium/Metal does not match other silver legs.

Bases ship unassembled unless otherwise specified. Tops are not pre-drilled.

LEAD TIME

training tables

Bases, for Training Table Tops

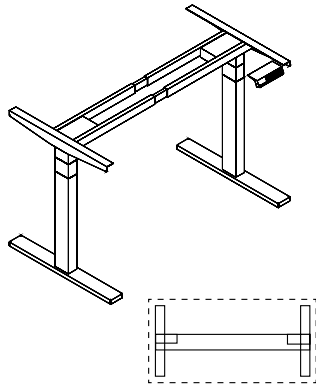

Adjustable Height Electrical Base (Sit to stand, fits top sizes below)

Model#	Base (D)	Base (W)	Height	Fits Top Size	Color	Weight	Cube	Price
MMLEGAHE24S3	22"	47"-72"	23 1/2"-49"	24"D-72"W	Silver	66	1	\$1,498
MMLEGAHE24B3	22"	47"-72"	23 1/2"-49"	24"D-72"W	Black	66	1	\$1,498
MMLEGAHE24W3	22"	47"-72"	23 1/2"-49"	24"D-72"W	White	66	1	\$1,498
MMLEGAHE30S3	28"	47"-72"	23 1/2"-49"	30"D-72"W	Silver	66	1	\$1,498
MMLEGAHE30B3	28"	47"-72"	23 1/2"-49"	30"D-72"W	Black	66	1	\$1,498
MMLEGAHE30W3	28"	47"-72"	23 1/2"-49"	30"D-72"W	White	66	1	\$1,498

Does not include top. **3 stage base.** Bases ship unassembled unless otherwise specified.

15 LEAD TIME

Handset	Push Button/4 memory presets
Motor	Dual motor
Foot Length	28"
Height range (excluding top)	23.5" – 49"
Frame width	Width adjustable 48" – 72"
Worksurface widths	48" – 72"
Worksurface depths	24" & 30"
Max lifting capacity	250lbs.
Base Weight	66lbs.
Speed	30mm/s
Warranty	5 years

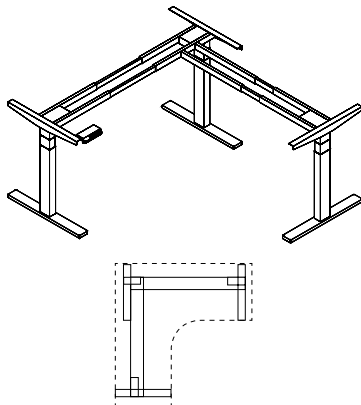

Adjustable Height Electrical L-Unit Base (Sit to stand, fits top sizes below)

Model#	Base (D)	Base (W)	Height	Fits Top Size	Color	Weight	Cube	Price
MMLEGAHEL24B3	22"	48"-72"	23 1/2"-49"	24"D-72"W	Black	112	1	\$2,295
MMLEGAHEL24S3	22"	48"-72"	23 1/2"-49"	24"D-72"W	Silver	112	1	\$2,295
MMLEGAHEL24W3	22"	48"-72"	23 1/2"-49"	24"D-72"W	White	112	1	\$2,295
MMLEGAHEL30S3	28"	48"-72"	23 1/2"-49"	30"D-72"W	Silver	112	1	\$2,295
MMLEGAHEL30W3	28"	48"-72"	23 1/2"-49"	30"D-72"W	White	112	1	\$2,295
MMLEGAHEL30B3	28"	48"-72"	23 1/2"-49"	30"D-72"W	Black	112	1	\$2,295

Does not include top. **3 stage base.** Bases ship unassembled unless otherwise specified.

15 LEAD TIME

Handset	Push Button/4 memory presets
Motor	Triple motor
Foot Length	28"
Height range (excluding top)	23.5" – 49"
Frame width	Width adjustable 48" – 72"
Worksurface widths	48" – 72"
Worksurface depths	24" & 30"
Max lifting capacity	300lbs.
Base Weight	112lbs.
Speed	33mm/s
Warranty	5 years

training tables

Bases, for Training Table Tops

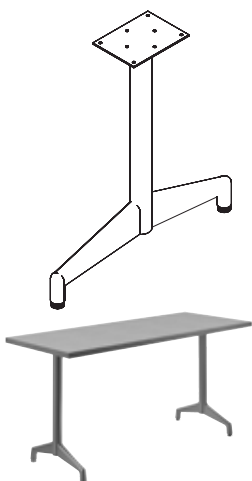

T-Leg with Leveler (Set of 2 legs)

Model#	Depth	Width	Height	Fits Top Size	Color	Weight	Cube	Price
MMLEGL20B	20"	2 1/4"	28"	20/24"D-72"W	Black	23	4	\$1,048
MMLEGL20S	20"	2 1/4"	28"	20/24"D-72"W	Silver	23	4	\$1,048
MMLEGL20W	20"	2 1/4"	28"	20/24"D-72"W	White	23	4	\$1,048
MMLEGL30B	30"	2 1/4"	28"	30/36"D-72"W	Black	23	4	\$1,126
MMLEGL30S	30"	2 1/4"	28"	30/36"D-72"W	Silver	23	4	\$1,126
MMLEGL30W	30"	2 1/4"	28"	30/36"D-72"W	White	23	4	\$1,126

Column diameter 2 1/4". Mounting plate 6"D x 8"W. Base Spread: 20"D is 20"W. 30"D is 26"W.
 Stabilizer Bar: 1 is included with 60"W, 66"W & 72"W tops, when ordered with T-Legs.
 Legs ship unassembled unless otherwise specified. **15** LEAD TIME

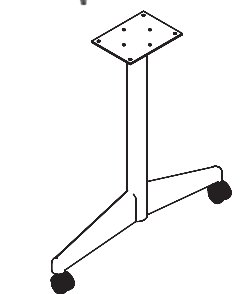

T-Leg with Casters (Set of 2 legs, locking casters)

Model#	Depth	Width	Height	Fits Top Size	Color	Weight	Cube	Price
MMLEGTC20B	20"	2 1/4"	28"	20/24"D-72"W	Black	23	4	\$1,069
MMLEGTC20S	20"	2 1/4"	28"	20/24"D-72"W	Silver	23	4	\$1,069
MMLEGTC20W	20"	2 1/4"	28"	20/24"D-72"W	White	23	4	\$1,069
MMLEGTC30B	30"	2 1/4"	28"	30/36"D-72"W	Black	23	4	\$1,147
MMLEGTC30S	30"	2 1/4"	28"	30/36"D-72"W	Silver	23	4	\$1,147
MMLEGTC30W	30"	2 1/4"	28"	30/36"D-72"W	White	23	4	\$1,147

Column diameter 2 1/4". Mounting plate 6"D x 8"W. Base Spread: 20"D is 20"W. 30"D is 26"W.
 Stabilizer Bar: 1 is included with 60"W, 66"W & 72"W tops, when ordered with T-Legs.
 Legs ship unassembled unless otherwise specified. **15** LEAD TIME

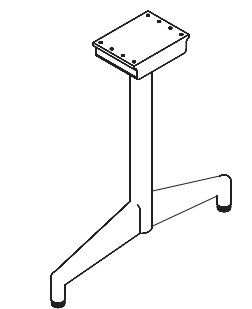

Flip Top Base with Leveler (Set of 2 legs)

Model#	Depth	Width	Height	Fits Top Size	Color	Weight	Cube	Price
MMLEGTFL20B	20"	2 1/4"	28"	20/24"D-72"W	Black	23	4	\$1,384
MMLEGTFL20S	20"	2 1/4"	28"	20/24"D-72"W	Silver	23	4	\$1,384
MMLEGTFL20W	20"	2 1/4"	28"	20/24"D-72"W	White	23	4	\$1,384
MMLEGTFL30B	30"	2 1/4"	28"	30/36"D-72"W	Black	23	4	\$1,434
MMLEGTFL30S	30"	2 1/4"	28"	30/36"D-72"W	Silver	23	4	\$1,434
MMLEGTFL30W	30"	2 1/4"	28"	30/36"D-72"W	White	23	4	\$1,434

Column diameter 2 1/4". Flip top mechanism is mechanically attached to the base.
 Base Spread: 20"D is 20"W. 30"D is 26"W. Use with rectangular tops, see pages 113-114.
 Stabilizer Bar: 1 is included with 60"W, 66"W & 72"W tops, when ordered with Flip Top Base.
 Base ship unassembled unless otherwise specified. **15** LEAD TIME

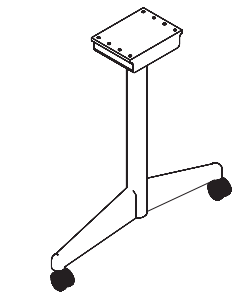

Flip Top Base with Casters (Set of 2 legs, locking casters)

Model#	Depth	Width	Height	Fits Top Size	Color	Weight	Cube	Price
MMLEGTFC20B	20"	2 1/4"	28"	20/24"D-72"W	Black	23	4	\$1,456
MMLEGTFC20S	20"	2 1/4"	28"	20/24"D-72"W	Silver	23	4	\$1,456
MMLEGTFC20W	20"	2 1/4"	28"	20/24"D-72"W	White	23	4	\$1,456
MMLEGTFC30B	30"	2 1/4"	28"	30/36"D-72"W	Black	23	4	\$1,507
MMLEGTFC30S	30"	2 1/4"	28"	30/36"D-72"W	Silver	23	4	\$1,507
MMLEGTFC30W	30"	2 1/4"	28"	30/36"D-72"W	White	23	4	\$1,507

Column diameter 2 1/4". Flip top mechanism is mechanically attached to the base.
 Base Spread: 20"D is 20"W. 30"D is 26"W. Use with rectangular tops, see pages 113-114.
 Stabilizer Bar: 1 is included with 60"W, 66"W & 72"W tops, when ordered with Flip Top Base.
 Base ship unassembled unless otherwise specified. **15** LEAD TIME



NOTES:

- All bases on this page, for heavy use on 60"W or wider tops, a second stabilizer bar is recommended.
- If using 84"W tops, one stabilizer bar MMSB72 is required.
- See page 120 for stabilizer bar sizes & pricing.

Hinged Modesty Panels available for Bases above, see page 120.

training tables

Bases, for Training Table Tops

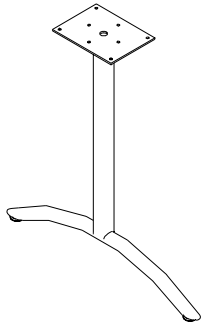

Arch T-Metal Base with Levelers (Set of 2 legs)

Model#	Depth	Width	Height	Fits Top Depth	Color	Weight	Cube	Price
MMLEGATL22B	22"	2"	27 3/4"	20-24"D-72"W	Black	23	4	\$1,262
MMLEGATL22S	22"	2"	27 3/4"	20-24"D-72"W	Silver	23	4	\$1,262
MMLEGATL22W	22"	2"	27 3/4"	20-24"D-72"W	White	23	4	\$1,262
MMLEGATL26B	26"	2"	27 3/4"	30-36"D-72"W	Black	23	4	\$1,291
MMLEGATL26S	26"	2"	27 3/4"	30-36"D-72"W	Silver	23	4	\$1,291
MMLEGATL26W	26"	2"	27 3/4"	30-36"D-72"W	White	23	4	\$1,291

Column diameter 2". Mounting plate 6"D x 8"W.
Stabilizer Bar: 1 is included with 60"W, 66"W & 72"W tops, when ordered with T-Legs.
Legs ship unassembled unless otherwise specified. Ⓛ LEAD TIME

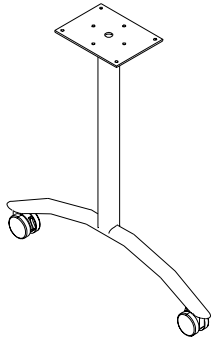

Arch T-Metal Base with Casters (Set of 2 legs)

Model#	Depth	Width	Height	Fits Top Depth	Color	Weight	Cube	Price
MMLEGATC22B	22"	2"	27 3/4"	20-24"D-72"W	Black	23	4	\$1,377
MMLEGATC22S	22"	2"	27 3/4"	20-24"D-72"W	Silver	23	4	\$1,377
MMLEGATC22W	22"	2"	27 3/4"	20-24"D-72"W	White	23	4	\$1,377
MMLEGATC26B	26"	2"	27 3/4"	30-36"D-72"W	Black	23	4	\$1,420
MMLEGATC26S	26"	2"	27 3/4"	30-36"D-72"W	Silver	23	4	\$1,420
MMLEGATC26W	26"	2"	27 3/4"	30-36"D-72"W	White	23	4	\$1,420

Column diameter 2". Mounting plate 6"D x 8"W.
Stabilizer Bar: 1 is included with 60"W, 66"W & 72"W tops, when ordered with T-Legs.
Legs ship unassembled unless otherwise specified. Ⓛ LEAD TIME

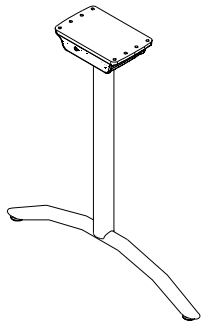

Flip Top Arch T-Metal Base with Levelers (Set of 2 legs)

Model#	Depth	Width	Height	Fits Top Depth	Color	Weight	Cube	Price
MMLEGATFL22B	22"	2"	27 3/4"	20-24"D-72"W	Black	23	4	\$2,219
MMLEGATFL22S	22"	2"	27 3/4"	20-24"D-72"W	Silver	23	4	\$2,219
MMLEGATFL22W	22"	2"	27 3/4"	20-24"D-72"W	White	23	4	\$2,219
MMLEGATFL26B	26"	2"	27 3/4"	30-36"D-72"W	Black	23	4	\$2,262
MMLEGATFL26S	26"	2"	27 3/4"	30-36"D-72"W	Silver	23	4	\$2,262
MMLEGATFL26W	26"	2"	27 3/4"	30-36"D-72"W	White	23	4	\$2,262

Column diameter 2". Flip top mechanism is mechanically attached to the base.
Use with rectangular tops, see pages 113-114.
Stabilizer Bar: 1 is included with 60"W, 66"W & 72"W tops, when ordered with Flip Top Base.
Base ship unassembled unless otherwise specified. Ⓛ LEAD TIME

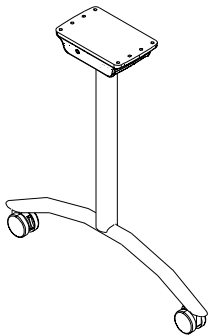

Flip Top Arch T-Metal Base with Casters (Set of 2 legs)

Model#	Depth	Width	Height	Fits Top Depth	Color	Weight	Cube	Price
MMLEGATFC22B	22"	2"	27 3/4"	20-24"D-72"W	Black	23	4	\$2,348
MMLEGATFC22S	22"	2"	27 3/4"	20-24"D-72"W	Silver	23	4	\$2,348
MMLEGATFC22W	22"	2"	27 3/4"	20-24"D-72"W	White	23	4	\$2,348
MMLEGATFC26B	26"	2"	27 3/4"	30-36"D-72"W	Black	23	4	\$2,376
MMLEGATFC26S	26"	2"	27 3/4"	30-36"D-72"W	Silver	23	4	\$2,376
MMLEGATFC26W	26"	2"	27 3/4"	30-36"D-72"W	White	23	4	\$2,376

Column diameter 2". Flip top mechanism is mechanically attached to the base.
Use with rectangular tops, see pages 113-114.
Stabilizer Bar: 1 is included with 60"W, 66"W & 72"W tops, when ordered with Flip Top Base.
Base ship unassembled unless otherwise specified. Ⓛ LEAD TIME

NOTES:

- All bases on this page, for heavy use on 60"W or wider tops, a second stabilizer bar is recommended.
- If using 84"W tops, one stabilizer bar MMSB72 is required.
- See page 120 for stabilizer bar sizes & pricing.



Hinged Modesty Panels available for Bases above, see page 120.

training tables

Modesty Panels

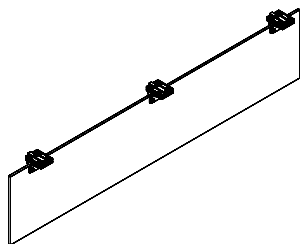

Frosted Acrylic Hinged Modesty (3/8" Thick, black clips)

Model#	Depth	Width	Height	Clips	Top Width	Weight	Cube	Price
MMTRAM54	3"	41"	13 1/2"	2	54"	10	2	\$1,025
MMTRAM60	3"	47"	13 1/2"	2	60"	11	2	\$1,031
MMTRAM66	3"	53"	13 1/2"	3	66"	12	2	\$1,109
MMTRAM72	3"	59"	13 1/2"	3	72"	13	2	\$1,118

Designed to fit T-Legs and Flip Top Bases, see page 119. Modesty recommended inset: 20"D & 24"D is flush, 30"D is inset 6". Depth and Height includes clips. Must be field installed.

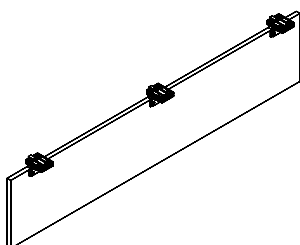

TFM Hinged Modesty (3/4" Thick, black clips)

Model#	Depth	Width	Height	Clips	Top Width	Weight	Cube	Price
MMTRWM54	3"	41"	13 1/2"	2	54"	10	2	\$334
MMTRWM60	3"	47"	13 1/2"	2	60"	11	2	\$359
MMTRWM66	3"	53"	13 1/2"	3	66"	12	2	\$441
MMTRWM72	3"	59"	13 1/2"	3	72"	13	2	\$441

Designed to fit T-Legs and Flip Top Bases, see page 119. Modesty recommended inset: 20"D & 24"D is flush, 30"D is inset 6". Depth and Height includes clips. Must be field installed.

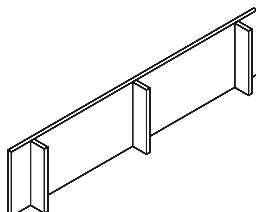

TFM Modesty (3/4" Thick, three vertical supports)

Model#	Depth	Width	Height	Top Width	Weight	Cube	Price
APPSLW54	4"	47"	12"	54"	15	2	\$158
APPSLW60	4"	53"	12"	60"	16	2	\$182
APPSLW66	4"	59"	12"	66"	18	2	\$193
APPSLW72	4"	65"	12"	72"	19	2	\$193

Ships with brackets for field installed. Tops are not predrilled.

NOTE: Modesty panel standard location is center left to right to approach side undertops. For custom location must specify, add MMCUT3 \$234.

Accessories and Upgrades

MMGANG3

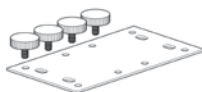

Ganging Hardware (For use with factory-installed metal inserts)

Model#	Depth	Width	Height	Hardware	Weight	Cube	Price
MMGANG3	4"	6"	1/4"	Ganging	1	1	\$54

MMGANG3: (1) Bracket & (4) Knobs. Recommended when placing tops side by side.



Grommet

Model#	Depth	Width	Color	Surface Hole Diameter	Price
MMGR234B	3"	3"	Black Plastic	2 3/4"	\$73
MMGR234S	3"	3"	Silver Plastic	2 3/4"	\$73
MMGR234BCOVER	Grommet cover only, Black (Field Install)				\$37
MMGR234SCOVER	Grommet cover only, Silver (Field Install)				\$37

Specify grommet locations. Standard left, right or center, see page 112 for standard location.

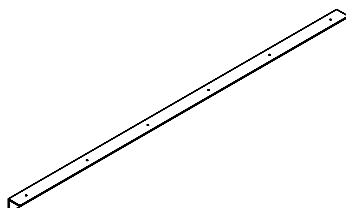

Stabilizer Bar, Black

Model#	Depth	Width	Height	Fits Top	Weight	Cube	Price
MMSB60	2"	44"	2"	60"W	6	1	\$155
MMSB66	2"	50"	2"	66"W	7	1	\$167
MMSB72	2"	56"	2"	72" / 84"W	8	1	\$181

May be purchased separately.

2 Stabilizer bars are included with 60"W, 66"W & 72"W tops, when purchased with top and post legs.

training tables TFM color options



metal leg color options

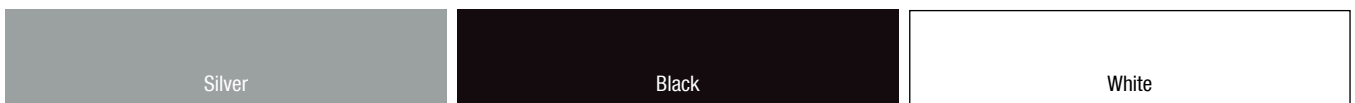

Laminate finishes & fabric samples shown are approximations. Colors may vary between factories. TFM & HPL laminate finishes will vary. Metal colors are not a match to other colors. For sample requests, email Maverick West: orderentry@maverickdesk.com. Maverick East: mveorders@maverickdesk.com
Note: Renderings & line drawings shown are a resemblance to finished product. Product designs may vary. Discounts are different between factories. Two standard colors may be specified at no charge. For three color combinations, email for quote.