

# Why Maverick? Features & Benefits

- Made in the U.S.A.
- Manufactured in Southern California and Fairfield, Ohio
- 10 Year Limited Manufacturer's Warranty
- Meets Air Resource Board – Airborne Toxic Control Measures to Reduce Formaldehyde Emissions
- 20 Standard Colors
- Mix and Match Two Colors at No Charge
- Tops and Chassis are 1" Durable Thermally Fused Melamine on 45lb. Industrial Strength Particle Board
- 2mm Thermally Fused PVC Edge Banding
- Metal to Metal Connection Fittings are Installed for Bridges and Returns
- All Products are Shipped Assembled, Some Items are Excluded
- Chassis Fastened by Screws, Steel Brackets and/or Concealed Fasteners
- Adjustable Leveling Glides
- 9-Ply Birch Wood Lacquer Finish Drawer Interiors
- All Drawers are Standard with 125lb. Full-extension, Progressive-Action Slides with Precision Steel Ball Bearings
- All Lateral Files Standard with 150lb. Override Full-Extension, Progressive-Action with Steel Ball Bearings
- Letter or Legal Filing on all File and Lateral File Drawers
- Metal to Metal Inserts on All Drawers for Easy Replacement
- Standard Locks, Grommets, and Handles
- Master Keys and Keyed-Alike Combinations are Available
- Custom Colors, Sizes and Configurations Available
- 3 Day Quick Ship

## Look For These Icons



This symbol marks Maverick series furniture that is available on our 3 day QuickShip program. Items will have this symbol. Order size limits may apply.



Product with this symbol has a standard 15 day lead time. This is subject to change due to production levels. Please contact customer service for current lead time. **West 800.414.1655. East 833.620.5778**



Product marked with this symbol is available in 20 days lead-time. This is subject to change due to production levels. Please contact customer service for current lead time. **West 800.414.1655. East 833.620.5778.**

- This catalog is divided into sections to help you quickly find the furniture and equipment that fits your needs.
- All prices in this catalog are suggested manufacturer's retail prices.
- Prices and product specifications are subject to change without notice.

## Additional Sites | Reference



2020.net



projectmatrix.com



configura.com



myresourcelibrary.com



kisp.com/kits

## Dealer Tools

For the latest information on products and updates visit:

[www.maverickdesk.com](http://www.maverickdesk.com)

# maverick series



Maverick Series, our popular and complete series combines classic all-laminate designs with the ability to mix and match two of our 20 standard colors to provide modern day durability for any office space. It features standard full modesty panels, full pedestals to floor, face locks, handles, grommets on credenzas, bridges, and returns. Hutches with standard fascia.

## Storage Units | Adjustable Desks



## Conference Collection | Community Tables



# maverick series

 3 Days and  15 Lead Time

## Product Specifications

### Colors

- 20 standard colors are available on tops and chassis. Two colors may be specified at no charge.

### Top / Worksurfaces

- 1" TFM (Thermally Fused Melamine) on industrial quality (45 lb.) particleboard.
- 2mm thermally-fused PVC edge banding.
- Conference table tops present a 1¾" built-up edge.
- Metal-to-metal connection fittings are installed for bridges and returns.
- Woodgrain direction on tops of bridges and returns runs from user side to approach side to coordinate with main unit tops.

### Chassis Construction

- TFM chassis fastened by screws, steel brackets, and/or concealed fasteners.
- 1" Thick end panels on desks, returns, credenzas, and bookcases. ¾" Thick end panels on hutches.
- Full-height modesty panel is standard on all desks, credenzas, bridges & returns; ½" modesty may be specified at no upcharge on bridges and returns, where specified. Full pedestal to floor is standard. Full modesty is 27 ⅝"H and ½ modesty is 14"H.
- Bullet desks are standard with full modesty panel and have 4" black metal posts.
- Conference tables, see conference section for Maverick series (MM).
- Unless otherwise specified, conference and round table bases are the same color as the top. Contrasting colors may be specified at no charge.
- The modesty inset on the approach side for 30" deep tops is 6"; for 36" deep tops, inset is 12".
- The modesty panel is flush to the approach edge on 20" and 24" deep tops.
- Visible edges are edged with 2mm thermally-fused PVC edge banding.
- Adjustable leveling glides are provided on all units that are designed to be set on the floor.
- Hutches for Maverick Complete are designed to fit Maverick Complete.
- Product heights are coordinated to facilitate matching, e.g., credenza plus hutch is 65" high. Optional 72" height is available.
- Standard woodgrain direction on the modesty of pieces 60" wide or less is vertical. On pieces wider than 60", the grain direction is horizontal.
- Lateral file and vertical file chassis are all ¾" material.

### Drawer Interiors

- 9-ply Birch wood drawers.

### Drawer Suspension, Construction and Doors

- Box drawers have full-extension, progressive-action slides with precision steel ball bearings.
- Heavy-duty file rods in file drawers.
- H3B handles and locks are standard. (except hutches and hinged door wall mounts)
- Overlay drawer front and doors are standard on all separate storage units and separate file units. Other furniture with storage and lateral file elements are inset to the end panels of chassis and overlay at the kneespace.
- All file and lateral drawers file legal-size from side-to-side.
- Each desk only is provided with one box drawer convenience tray. See page 58 for optional additional trays for other units.
- File drawer construction accommodates hanging files not stacked material on drawer bottom.
- Hutch doors overlay sides before inset to top with 19" clearance below.

### Cord Management

- Centered grommets in the worksurface and modesty are standard on bridges, credenzas and returns; ¾" clearance at bottom of hutch backs.
- Optional grommets on page 56.

### Locks

- Face locks are standard on all pedestals, lateral files, freestanding pedestals and storage cabinets where specified.
- Black or silver, removable cores are standard for all locks.
- Lock numbers (#101-115) are randomly assigned to all locking pedestals, except that double pedestal units will be keyed alike.
- Key alike may be specified at no charge.
- Master keys are available for purchase, see page 58.

**Note:** Dimensions assigned in this price list are nominal. If exact measurements are required, the requirement must be specified in the order and specifically acknowledged by Maverick. Maverick reserves the right to change construction details and standards without notification, if necessary.

**Line Drawings shown are a resemblance to finished product. Product designs may vary. Discounts are different between factories. Colors may vary between factories.**

## How to Order Maverick Series

### WORKSURFACE UNITS: DESK, CREDENZAS AND RETURNS

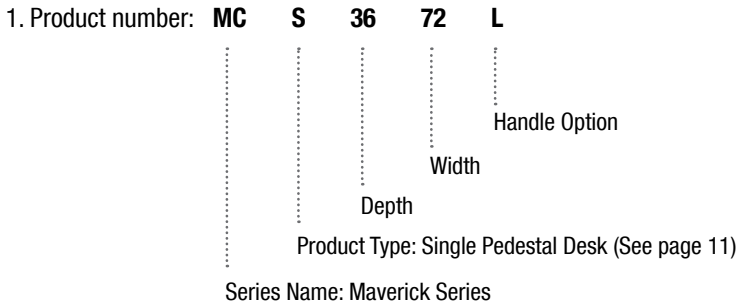

- Specify worksurface color. Matching color edge is standard.
- Specify drawer or door front color (matching color edgeband only).
- Specify chassis color. Matching color edge banding is standard. Modesty color same as chassis only. (Chassis color excludes different colors for modesties, back panels & shelves)
- Specify handle option. Choice of handle is standard. H3B is standard if none specified. (Handles H11, H30, & APH1 charges apply)
- Black grommets are standard where shown on line drawings.
- Specify other accessories or upgrades. See pages 56–59.

### STANDARD HANDLE OPTIONS

H3B is standard unless otherwise specified.



Crescent Black  
(MMH3B)



Crescent Silver  
(MMH3S)



Elliptical Black  
(MMH5B)



Elliptical Silver  
(MMH5S)



Crescent Textured Nickel  
(MMH6)



Flared Nickel  
(MMH7)



Bow Handle  
(MMH8)



Curved Handle  
(MMH9)



Bar Square Handle  
(MMH10B)



Bar Square Handle  
(MMH10S)



Bar Handle  
(MMH13)



Bar Handle  
(MMH14)

**IMPORTANT NOTE:** Handles & locks are standard on all pedestals, lateral files, free standing pedestals and cabinets where specified.

# maverick series

## EDGE PROFILE

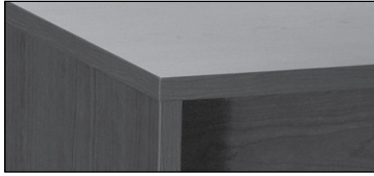

2mm flat PVC edge banding on tops

## SIDE VIEW



## FEATURES

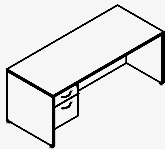

3/4 Pedestal box/file (S)

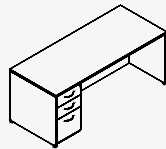

Full Pedestal box/box/file (C)

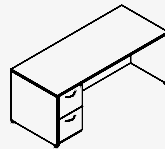

Full Pedestal file/file (D)

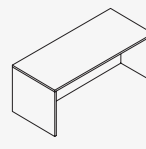

Full Modesty (FMP)

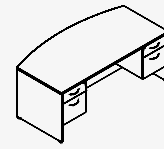

Fan Top (F)

## GROMMETS



GROMMET

Black grommets are standard where shown. Upgrade to silver color at no charge.

**NOTE:** While sitting at unit, grommet locations named from left to right. For grommet location on tops and/or modesty panel specify left, center or right. **No grommets over pedestals.**

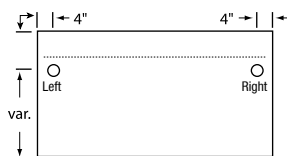

Desks

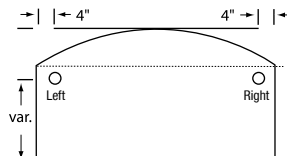

Desks

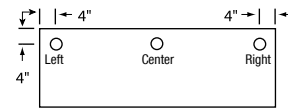

Credenza, Return, Bridges\*

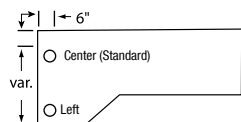

CompuCredenza\*

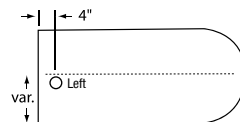

Bullets\*

**\*NOTE: BLACK GROMMETS ARE STANDARD WHERE SHOWN ON LINE DRAWINGS**

# maverick series

## Statement of Line

### DESKS

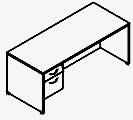

Desk - single pedestal (S)

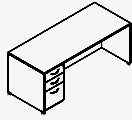

Desk - single pedestal (SC)

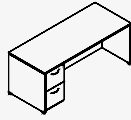

Desk - single pedestal (SD)

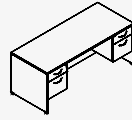

Desk - double pedestal (D)

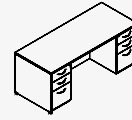

Desk - double pedestal (DC)

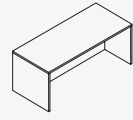

Desk - shell (N)

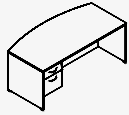

Desk Fan Top - sgl. ped. (FS)

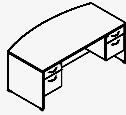

Desk Fan Top - dbl. ped. (FD)



Bullet Computer Desk (BDC)



Bullet Computer Desk Curved (BDCQ)



Bullet Desk - standard (BD)



Desk - P-shape (PBD)

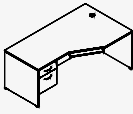

Comp. Desk - sgl. ped. (CD72 9)

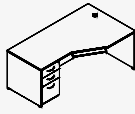

Comp. Desk - sgl. ped. (CD72C 9)

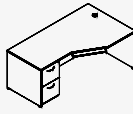

Comp. Desk - sgl. ped. (CD72D 9)

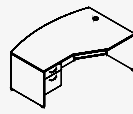

Fan Top Comp. Desk - sgl. ped. (FCD72 9)

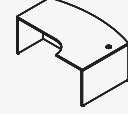

Fan Top Comp. Desk Curved - shell (FCDNQ72 9)



Curve Comp. Desk Shell (CDNQ72 9)

### CREDENZAS

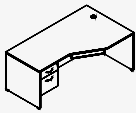

CompuCorner - sgl. ped. (CD)

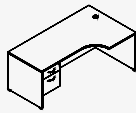

CompuCorner Curved - sgl. ped. (CDQ)

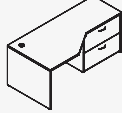

CompuCorner - 31" lateral (CDLF)

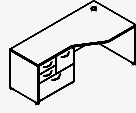

CompuCorner - 31" pers. lat. file (CDPLF)

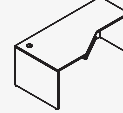

CompuCorner - shell (CDN)

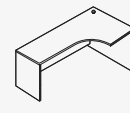

CompuCorner - curved shell (CDNQ)

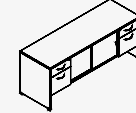

Credenza - dbl. ped. & storage (C\_\_\_2)

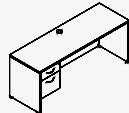

Credenza - sgl. ped. (C\_\_\_4)

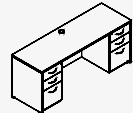

Credenza - double pedestal (C\_\_\_3)

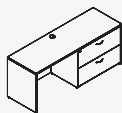

Credenza - lat. file (C\_\_\_5)

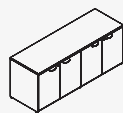

Credenza - full storage (C\_\_\_1FP)

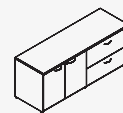

Credenza - storage file (C\_\_\_9FP)

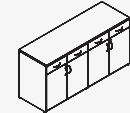

Buffet Credenza (HDBC\_\_\_)

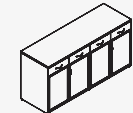

Buffet Credenza (HDBC\_\_\_G)

### RETURNS

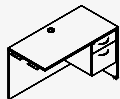

Return - BF (RA)

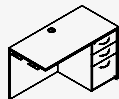

Return - BBF (RC)

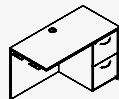

Return - FF (RD)

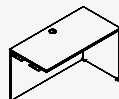

Return - shell (RN)

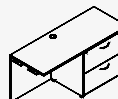

Return - lat. file (RLF)

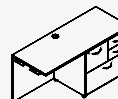

Return - pers. lat. file (RPLF)

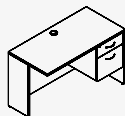

Return - BF (HARA)

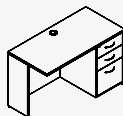

Return - BBF (HARC)

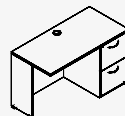

Return - FF (HARD)

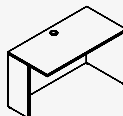

Return - shell (HARN)

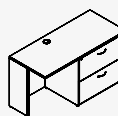

Return - lat. file (HARLF)

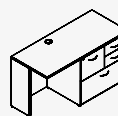

Return - pers. lat. file (HARPLF)

### BRIDGE

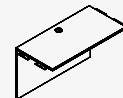

Bridge (BR)

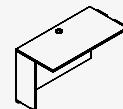

Bridge (HABR)

# maverick series

## Statement of Line

### HUTCHES

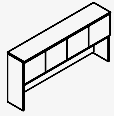

Hutch - with doors  
(H\_WD)

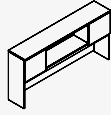

Hutch - 2 door  
(H\_W2D)

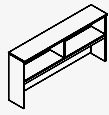

Hutch - no doors  
(H\_ND)

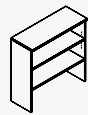

Hutch - bookcase  
(BCH)

### ADJUSTABLE DESKS

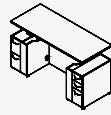

Adjustable Desk -  
dbl. ped.  
(HADCD)

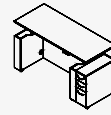

Adjustable Desk -  
sgl. ped.  
(HAS)

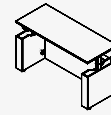

Adjustable Desk -  
shell  
(HAN)

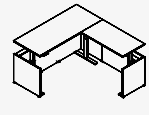

Adjustable L-Shape Desk -  
shell  
(HALN)

### RISERS



Riser - 36"  
(RB)



Riser - 48"  
(RB)

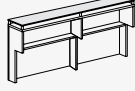

Riser - 72"  
(RB)

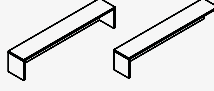

Riser Return  
(RBR)

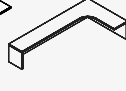

Riser L-Shape  
(RBL)

### RECEPTIONS

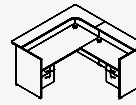

Reception - \"L\"  
(RCAL)

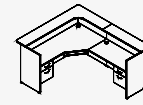

Reception - computer  
(RCDL)

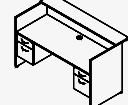

Reception - front  
(RCAD)

### BOOKCASES

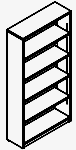

Bookcase  
(BC)

### FILING



Lateral File  
(LF2)



Lateral File - 3-draw  
(LF3)



Lateral File - 4-draw  
(LF4)

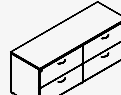

Lateral File - double  
(LF\_2+2)

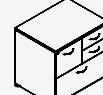

Lateral File - personal  
(PLF)



Vertical File  
(VF)

### STORAGE



Cabinet - single  
(STS)

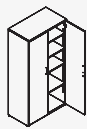

Cabinet - double  
(ST)

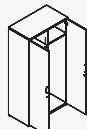

Cabinet - wardrobe  
(WC)

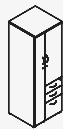

Personal Storage Unit  
(WCP)

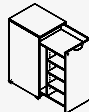

Side Door Storage Cabinet  
(MCSDS)

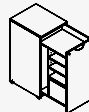

Side Door Storage Cabinet  
(MCSDF)

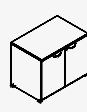

Cabinet - utility  
(HDC)

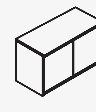

Cabinet - wall mount  
(CFOHD)



Locker - face lock  
(MCSL 4R)

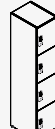

Locker - digital lock  
(MCSL 4RZ)

### STANDS



Printer Stand  
(PS)

### PEDESTALS



Mobile - box/box/file  
(PEDCX)



Mobile - file/file  
(PEDDX)



Mobile - pencil/box/file  
(PEDEX)



Mobile - box/file  
(PEDAX)



Slim Mobile - pencil/box/file  
(PEDSX)

### CONFERENCE

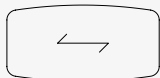

Conference Table - boatshape  
(BS)

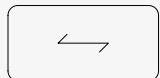

Conference Table - rectangular  
(RE)

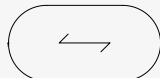

Conference Table - racetrack  
(RT)

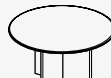
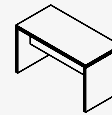

Table - round  
(RD)



Lectern  
(LEC)



Community Table  
(NCT)

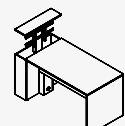

Community Monitor Table  
(NCTATV)

# maverick series

Configurations - Are available for  and 

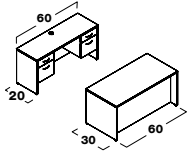

☞ MC1		
1 MCD3060	\$1,866	
1 MCC2060 3	\$1,996	
	<b>\$3,862</b>	

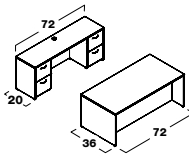

☞ MC2		
1 MCDC3672	\$3,140	
1 MCCD2072 3	\$3,033	
	<b>\$6,173</b>	

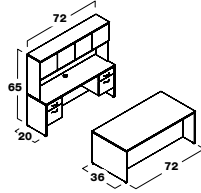

☞ MC3		
1 MCD3672	\$2,252	
1 MCC2072 3	\$2,348	
1 MCH72WD	\$2,065	
	<b>\$6,665</b>	

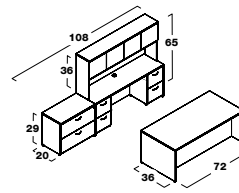

☞ MC4		
1 MCDC3672	\$3,140	
1 MCCD2072 3	\$3,033	
1 MCH72WD	\$2,065	
1 MCLF202	\$1,759	
	<b>\$9,997</b>	

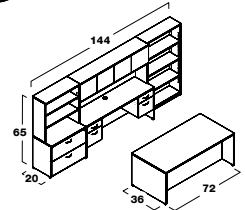

☞ MC5		
1 MCD3672	\$2,252	
1 MCC2072 3	\$2,348	
1 MCH72WD	\$2,065	
1 MCLF202	\$1,759	
1 MCBCH36	\$682	
1 MCBC3665	\$1,185	
	<b>\$10,291</b>	

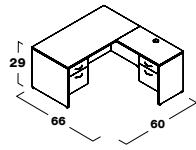

☞ MC6R		
1 MCS3060L	\$1,503	
1 MCRA2036R	\$1,425	
	<b>\$2,928</b>	

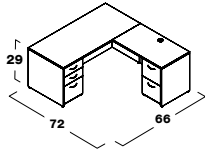

☞ MC7R		
1 MCSC3066L	\$2,292	
1 MCRD2442R	\$2,132	
	<b>\$4,424</b>	

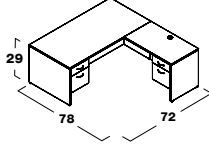

☞ MC8R		
1 MCS3672L	\$1,763	
1 MCRA2442R	\$1,620	
	<b>\$3,383</b>	

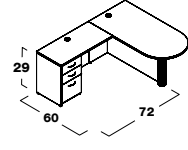

☞ MC9L		
1 MCB3060L	\$1,407	
1 MCR2042L	\$2,081	
	<b>\$3,488</b>	

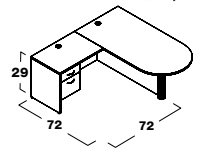

☞ MC10L		
1 MCB3672L	\$1,678	
1 MCRA2436L	\$1,577	
	<b>\$3,255</b>	

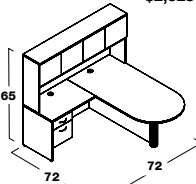

☞ MC11L		
1 MCB3672L	\$1,678	
1 MCRA2436L	\$1,577	
1 MCH72WD	\$2,065	
	<b>\$5,320</b>	

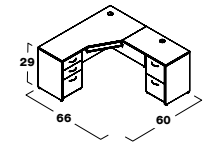

☞ MC12R		
1 MCC66C 4L	\$2,521	
1 MCRD2436R	\$2,116	
	<b>\$4,637</b>	

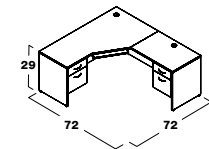

☞ MC13R		
1 MCCD72 4L	\$1,814	
1 MCRA2436R	\$1,577	
	<b>\$3,391</b>	

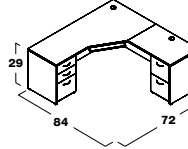

☞ MC14R		
1 MCCD72C 4L	\$2,439	
1 MCRD2448R	\$2,180	
	<b>\$4,619</b>	

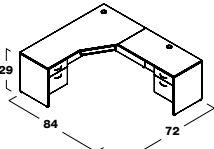

☞ MC15R		
1 MCCD72 4L	\$1,814	
1 MCRA2448R	\$1,642	
	<b>\$3,456</b>	

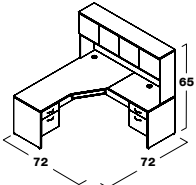

☞ MC16R		
1 MCCD72 4L	\$1,814	
1 MCRA2436R	\$1,577	
1 MCH72WD	\$2,065	
	<b>\$5,456</b>	

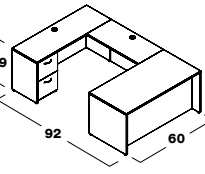

☞ MC17L		
1 MCSC3060R	\$2,132	
1 MCBR2042	\$645	
1 MCCD2060 4L	\$2,121	
	<b>\$4,898</b>	

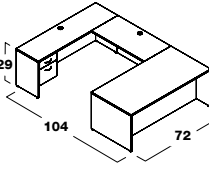

☞ MC18L		
1 MCS3672R	\$1,763	
1 MCBR2448	\$851	
1 MCC2072 4L	\$1,792	
	<b>\$4,406</b>	

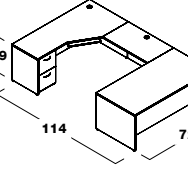

☞ MC19L		
1 MCSC3672R	\$2,396	
1 MCBR2442	\$785	
1 MCCD72D 4L	\$2,347	
	<b>\$5,528</b>	

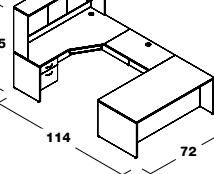

☞ MC20L		
1 MCS3672R	\$1,763	
1 MCBR2442	\$785	
1 MCCD72 4L	\$1,814	
1 MCH72WD	\$2,065	
	<b>\$6,427</b>	

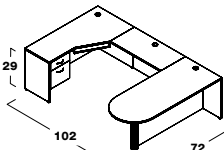

☞ MC21L		
1 MCB3072L	\$1,588	
1 MCBR2042	\$645	
1 MCCD60 2L	\$1,744	
	<b>\$3,977</b>	

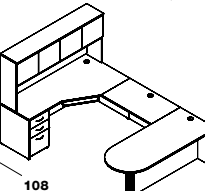

☞ MC22L		
1 MCB3072L	\$1,588	
1 MCBR2442	\$785	
1 MCCD72C 4L	\$2,439	
1 MCH72WD	\$2,065	
	<b>\$6,877</b>	

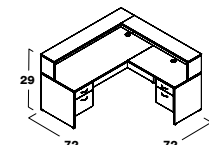

15 DAYS ☞ MC23R		
1 MCS3072L	\$1,687	
1 MCRA2442R	\$1,620	
1 MCRB72	\$1,098	
1 MCBR60R	\$868	
	<b>\$5,273</b>	

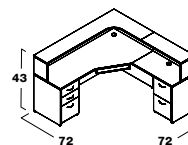

15 DAYS ☞ MC24R		
1 MCCD72C 7L	\$2,599	
1 MCRD2036R	\$1,962	
1 MCBRL3672R	\$1,605	
1 MCBR36R	\$540	
	<b>\$6,706</b>	

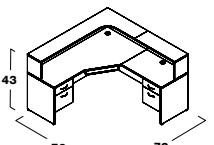

15 DAYS ☞ MC25R		
1 MCCD72 4L	\$1,814	
1 MCRA2436R	\$1,577	
1 MCBRL3672R	\$1,605	
1 MCBR36R	\$540	
	<b>\$5,536</b>	

Use "R" or "L" to indicate the position of the return. Configurations must be ordered as shown. Configurations can be used with limited upgrade options for ☞.



# maverick series

Curved Configurations & Teaming Set-up - Available for  and 

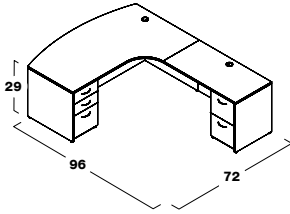

<b>15</b> DAYS	<b>MCQ26R</b>	
1	MCFC072C 9L	\$3,224
1	MCRD2448R	\$2,180
		<b>\$5,404</b>

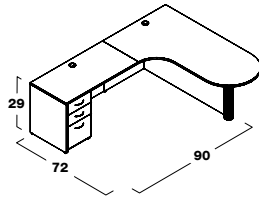

<b>C</b>	<b>MCQ27L</b>	
1	MCBDCQ427230L	\$1,711
1	MCRC2448L	\$2,276
		<b>\$3,987</b>

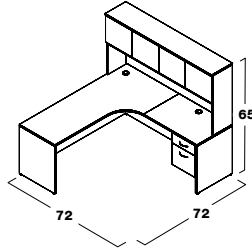

<b>C</b>	<b>MCQ28R</b>	
1	MCCDNQ72 4R	\$1,542
1	MCRA2436R	\$1,577
1	MCH72WD	\$2,065
		<b>\$5,184</b>

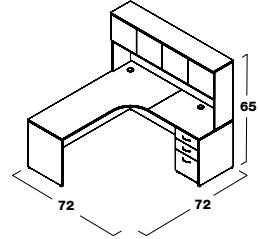

<b>C</b>	<b>MCQ29R</b>	
1	MCCDNQ72 4R	\$1,542
1	MCRC2436R	\$2,208
1	MCH72WD	\$2,065
		<b>\$5,815</b>

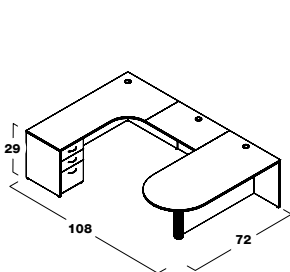

<b>C</b>	<b>MCQ30L</b>	
1	MCBD3672L	\$1,678
1	MCBR2436	\$671
1	MCCDQ72C 4L	\$2,439
		<b>\$4,788</b>

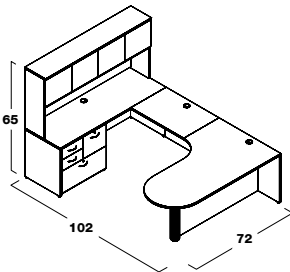

<b>15</b> DAYS	<b>MCQ31L</b>	
1	MCBDCQ427230L	\$1,711
1	MCBR2436	\$671
1	MCC2472 6L	\$2,976
1	MCH72WD	\$2,065
		<b>\$7,423</b>

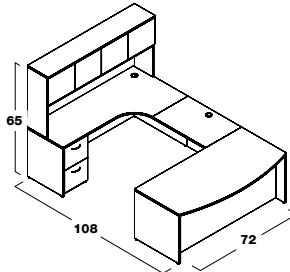

<b>C</b>	<b>MCQ32L</b>	
1	MCFSC3672R	\$2,759
1	MCBR2436	\$671
1	MCCDQ72D 4L	\$2,347
1	MCH72WD	\$2,065
		<b>\$7,842</b>

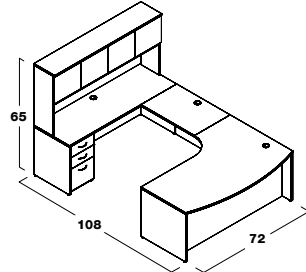

<b>15</b> DAYS	<b>MCQ33L</b>	
1	MCFC072C 9R	\$3,224
1	MCBR2436	\$671
1	MCCC2472 4L	\$2,465
1	MCH72WD	\$2,065
		<b>\$8,425</b>

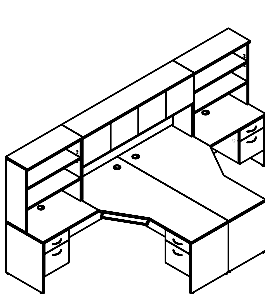

<b>C</b>	<b>MC34</b>	
1	MCCD72 4R	\$1,814
1	MCCD72 4L	\$1,814
1	MCRA2436R	\$1,577
1	MCRA2436L	\$1,577
2	MCBCH36	\$1,362
1	MCH72WD	\$2,065
		<b>\$10,211</b>

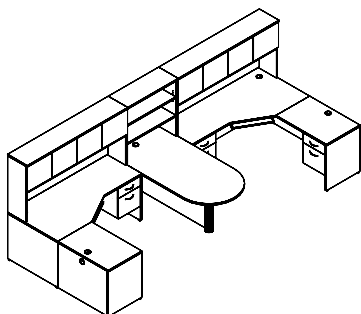

<b>C</b>	<b>MC35</b>	
1	MCCD72 4R	\$1,814
1	MCCD72 4L	\$1,814
1	MCRA2436R	\$1,577
1	MCRA2436L	\$1,577
1	MCBD3672L	\$1,678
2	MCH72WD	\$4,130
1	MCBCH36	\$682
		<b>\$13,272</b>

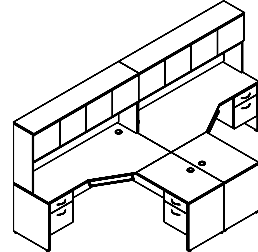

<b>C</b>	<b>MC36</b>	
1	MCCD72 4R	\$1,814
1	MCCD72 4L	\$1,814
1	MCRA2436R	\$1,577
1	MCRA2436L	\$1,577
2	MCH72WD	\$4,130
		<b>\$10,912</b>

**NOTE: BULLET DESK STAND ALONE WITH POST LEG, WHEN ORDERED AS MC35 CONFIGURATION, MUST SPECIFY.**

Use "R" or "L" to indicate the position of the return. Configurations must be ordered as shown.

# maverick series

## Desks

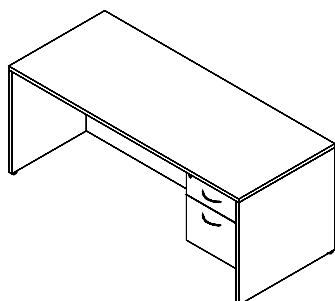

Single Pedestal Desk, Box/File Pedestal Right (Full modesty, H3B handles, lock)

Model#	Depth	Width	Height	Weight	Cube	Price
☞ MCS2042R	20"	42"	29"	120	15	\$1,392
☞ MCS2060R	20"	60"	29"	150	20	\$1,483
☞ MCS2066R	20"	66"	29"	156	23	\$1,643
☞ MCS2072R	20"	72"	29"	163	24	\$1,662
☞ MCS2442R	24"	42"	29"	127	18	\$1,433
☞ MCS2448R	24"	48"	29"	130	20	\$1,459
☞ MCS3048R	30"	48"	29"	142	25	\$1,479
☞ MCS3060R	30"	60"	29"	190	32	\$1,503
☞ MCS3066R	30"	66"	29"	197	35	\$1,662
☞ MCS3072R	30"	72"	29"	210	38	\$1,687
☞ MCS3672R	36"	72"	29"	225	45	\$1,763

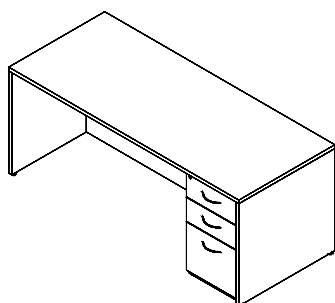

Single Pedestal Desk, Box/Box/File Pedestal Right (Full modesty, H3B handles, lock)

Model#	Depth	Width	Height	Weight	Cube	Price
☞ MCSC2042R	20"	42"	29"	155	15	\$2,020
☞ MCSC2060R	20"	60"	29"	180	20	\$2,107
☞ MCSC2066R	20"	66"	29"	190	23	\$2,268
☞ MCSC2072R	20"	72"	29"	200	24	\$2,292
☞ MCSC2442R	24"	42"	29"	175	18	\$2,065
☞ MCSC2448R	24"	48"	29"	183	20	\$2,090
☞ MCSC3048R	30"	48"	29"	203	25	\$2,107
☞ MCSC3060R	30"	60"	29"	224	32	\$2,132
☞ MCSC3066R	30"	66"	29"	234	35	\$2,292
☞ MCSC3072R	30"	72"	29"	244	38	\$2,314
☞ MCSC3672R	36"	72"	29"	267	45	\$2,396

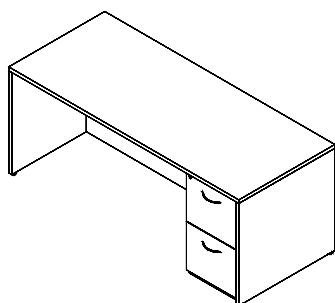

Single Pedestal Desk, File/File Pedestal Right (Full modesty, H3B handles, lock)

Model#	Depth	Width	Height	Weight	Cube	Price
☞ MCSD2042R	20"	42"	29"	155	15	\$1,928
☞ MCSD2060R	20"	60"	29"	180	20	\$2,017
☞ MCSD2066R	20"	66"	29"	190	23	\$2,177
☞ MCSD2072R	20"	72"	29"	200	24	\$2,198
☞ MCSD2442R	24"	42"	29"	175	18	\$1,971
☞ MCSD2448R	24"	48"	29"	183	20	\$1,998
☞ MCSD3048R	30"	48"	29"	203	25	\$2,017
☞ MCSD3060R	30"	60"	29"	224	32	\$2,039
☞ MCSD3066R	30"	66"	29"	234	35	\$2,198
☞ MCSD3072R	30"	72"	29"	244	38	\$2,224
☞ MCSD3672R	36"	72"	29"	267	45	\$2,302

**NOTE: 60"W desks are recommended with 20"D returns.**

For available accessories and upgrades, see pages 56–59.

# maverick series

## Desks

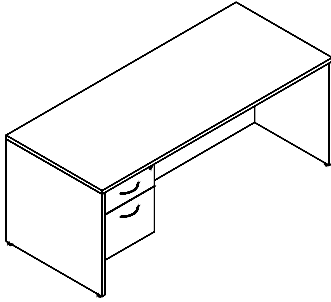

Single Pedestal Desk, Box/File Pedestal Left (Full modesty, H3B handles, lock)

Model#	Depth	Width	Height	Weight	Cube	Price
☞ MCS2042L	20"	42"	29"	120	15	\$1,392
☞ MCS2060L	20"	60"	29"	150	20	\$1,483
☞ MCS2066L	20"	66"	29"	156	23	\$1,643
☞ MCS2072L	20"	72"	29"	163	24	\$1,662
☞ MCS2442L	24"	42"	29"	127	18	\$1,433
☞ MCS2448L	24"	48"	29"	130	20	\$1,459
☞ MCS3048L	30"	48"	29"	142	25	\$1,479
☞ MCS3060L	30"	60"	29"	190	32	\$1,503
☞ MCS3066L	30"	66"	29"	197	35	\$1,662
☞ MCS3072L	30"	72"	29"	210	38	\$1,687
☞ MCS3672L	36"	72"	29"	225	45	\$1,763

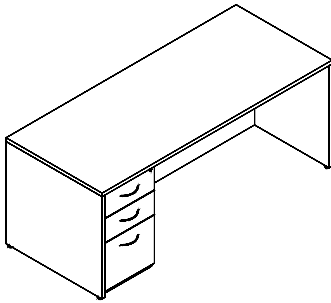

Single Pedestal Desk, Box/Box/File Pedestal Left (Full modesty, H3B handles, lock)

Model#	Depth	Width	Height	Weight	Cube	Price
☞ MCSC2042L	20"	42"	29"	120	15	\$2,020
☞ MCSC2060L	20"	60"	29"	150	20	\$2,107
☞ MCSC2066L	20"	66"	29"	156	23	\$2,268
☞ MCSC2072L	20"	72"	29"	163	24	\$2,292
☞ MCSC2442L	24"	42"	29"	127	18	\$2,065
☞ MCSC2448L	24"	48"	29"	130	20	\$2,090
☞ MCSC3048L	30"	48"	29"	142	25	\$2,107
☞ MCSC3060L	30"	60"	29"	190	32	\$2,132
☞ MCSC3066L	30"	66"	29"	197	35	\$2,292
☞ MCSC3072L	30"	72"	29"	210	38	\$2,314
☞ MCSC3672L	36"	72"	29"	225	45	\$2,396

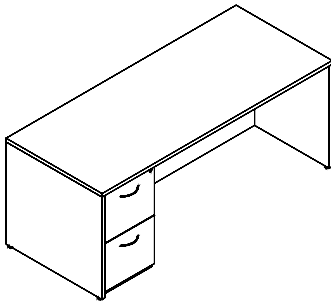

Single Pedestal Desk, File/File Pedestal Left (Full modesty, H3B handles, lock)

Model#	Depth	Width	Height	Weight	Cube	Price
☞ MCSD2042L	20"	42"	29"	120	15	\$1,928
☞ MCSD2060L	20"	60"	29"	150	20	\$2,017
☞ MCSD2066L	20"	66"	29"	156	23	\$2,177
☞ MCSD2072L	20"	72"	29"	163	24	\$2,198
☞ MCSD2442L	24"	42"	29"	127	18	\$1,971
☞ MCSD2448L	24"	48"	29"	130	20	\$1,998
☞ MCSD3048L	30"	48"	29"	142	25	\$2,017
☞ MCSD3060L	30"	60"	29"	190	32	\$2,039
☞ MCSD3066L	30"	66"	29"	197	35	\$2,198
☞ MCSD3072L	30"	72"	29"	210	38	\$2,224
☞ MCSD3672L	36"	72"	29"	225	45	\$2,302

**NOTE: 60"W desks are recommended with 20"D returns.**

For available accessories and upgrades, see pages 56–59.

# maverick series

## Desks

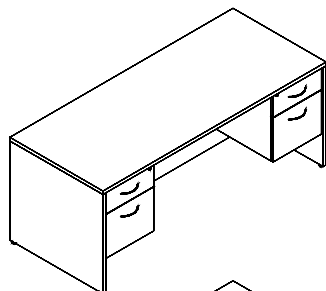

**Double Pedestal Desk, Box/File Pedestals Left and Right**  
(Full modesty, H3B handles, 2 locks)

Model#	Depth	Width	Height	Weight	Cube	Price
☞ MCD3060	30"	60"	29"	260	32	\$1,866
☞ MCD3066	30"	66"	29"	266	35	\$2,200
☞ MCD3072	30"	72"	29"	270	38	\$2,230
☞ MCD3672	36"	72"	29"	276	45	\$2,252

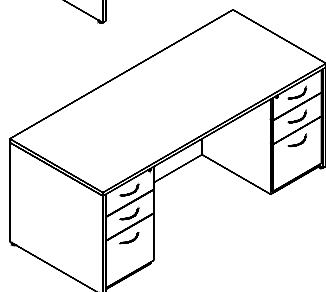

**Double Pedestal Desk, Box/Box/File Pedestals Left and Right**  
(Full modesty, H3B handles, 2 locks)

Model#	Depth	Width	Height	Weight	Cube	Price
☞ MCDC3060	30"	60"	29"	294	32	\$2,678
☞ MCDC3066	30"	66"	29"	304	35	\$3,083
☞ MCDC3072	30"	72"	29"	314	38	\$3,118
☞ MCDC3672	36"	72"	29"	337	45	\$3,140

For left Box/Box/File and right File/File configuration use MCDCD\_\_\_\_\_ at no charge.

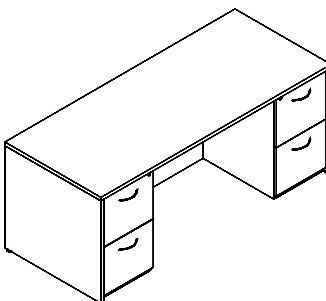

**Double Pedestal Desk, File/File Pedestals Left and Right**  
(Full modesty, H3B handles, 2 locks)

Model#	Depth	Width	Height	Weight	Cube	Price
☞ MCDD3060	30"	60"	29"	294	32	\$2,556
☞ MCDD3066	30"	66"	29"	304	35	\$2,960
☞ MCDD3072	30"	72"	29"	314	38	\$2,992
☞ MCDD3672	36"	72"	29"	337	45	\$3,016

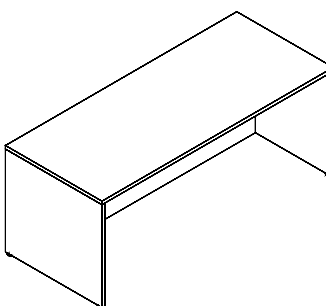

**Desk Shell No-Pedestal, Full Modesty (Flush modesty)**

Model#	Depth	Width	Height	Weight	Cube	Price
☞ MCN2042	20"	42"	29"	84	17	\$801
☞ MCN2048	20"	48"	29"	84	17	\$822
☞ MCN2060	20"	60"	29"	92	20	\$881
☞ MCN2066	20"	66"	29"	96	23	\$936
☞ MCN2072	20"	72"	29"	100	24	\$959
☞ MCN2436	24"	36"	29"	89	16	\$810
☞ MCN2442	24"	42"	29"	95	18	\$881
☞ MCN2448	24"	48"	29"	104	20	\$901
☞ MCN2460	24"	60"	29"	120	25	\$959
☞ MCN2466	24"	66"	29"	127	28	\$1,073
☞ MCN2472	24"	72"	29"	132	30	\$1,142

Modesty is flush.

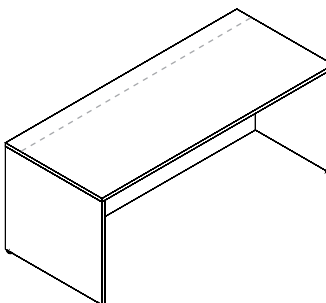

**Desk Shell No-Pedestal, Full Modesty (30"D-6" inset modesty, 36"D-12" inset modesty)**

Model#	Depth	Width	Height	Weight	Cube	Price
☞ MCN3042	30"	42"	29"	114	22	\$959
☞ MCN3048	30"	48"	29"	120	25	\$985
☞ MCN3060	30"	60"	29"	126	32	\$1,006
☞ MCN3066	30"	66"	29"	132	35	\$1,110
☞ MCN3072	30"	72"	29"	138	38	\$1,142
☞ MCN3672	36"	72"	29"	152	45	\$1,165

Modesty is Inset 6" on 30"D & 12" on 36"D.

For available accessories and upgrades, see pages 56–59.

# maverick series

## Desks

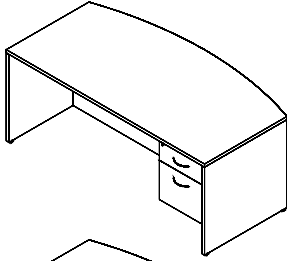

Fan Top Single Pedestal Desk, Box/File Right (Full modesty, H3B handles, lock)

Model#	Depth	Width	Height	Weight	Cube	Price
☞ MCF3672R	30-36"	72"	29"	233	45	\$2,129
☞ MCF4272R	36-42"	72"	29"	258	53	\$2,196

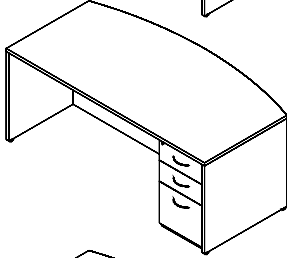

Fan Top Single Pedestal Desk, Box/Box/File Right (Full modesty, H3B handles, lock)

Model#	Depth	Width	Height	Weight	Cube	Price
☞ MCF3672R	30-36"	72"	29"	265	45	\$2,759
☞ MCF4272R	36-42"	72"	29"	280	53	\$2,825

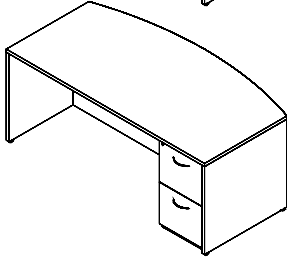

Fan Top Single Pedestal Desk, File/File Right (Full modesty, H3B handles, lock)

Model#	Depth	Width	Height	Weight	Cube	Price
☞ MCF3672R	30-36"	72"	29"	265	45	\$2,668
☞ MCF4272R	36-42"	72"	29"	280	53	\$2,729

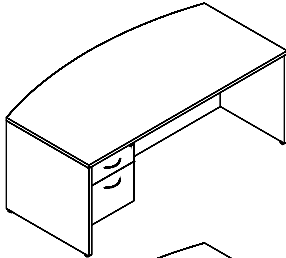

Fan Top Single Pedestal Desk, Box/File Left (Full modesty, H3B handles, lock)

Model#	Depth	Width	Height	Weight	Cube	Price
☞ MCF3672L	30-36"	72"	29"	233	45	\$2,129
☞ MCF4272L	36-42"	72"	29"	258	53	\$2,196

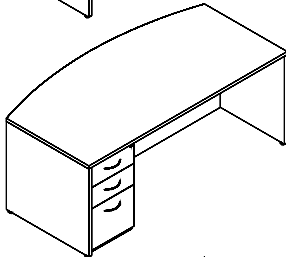

Fan Top Single Pedestal Desk, Box/Box/File Left (Full modesty, H3B handles, lock)

Model#	Depth	Width	Height	Weight	Cube	Price
☞ MCF3672L	30-36"	72"	29"	265	45	\$2,759
☞ MCF4272L	36-42"	72"	29"	280	53	\$2,825

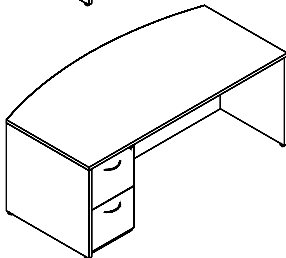

Fan Top Single Pedestal Desk, File/File Left (Full modesty, H3B handles, lock)

Model#	Depth	Width	Height	Weight	Cube	Price
☞ MCF3672L	30-36"	72"	29"	265	45	\$2,668
☞ MCF4272L	36-42"	72"	29"	280	53	\$2,729

For available accessories and upgrades, see pages 56–59.

# maverick series

## Desks

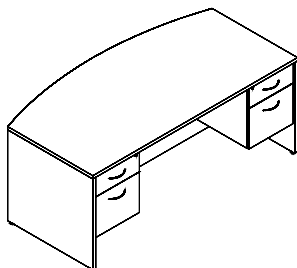

Fan Top Double Pedestal, Box/File Left and Right  
(Full modesty, H3B handles, 2 locks)

Model#	Depth	Width	Height	Weight	Cube	Price
☞ MCFD3672	30-36"	72"	29"	280	45	\$2,654
☞ MCFD4272	36-42"	72"	29"	305	53	\$2,674

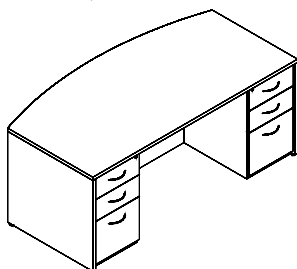

Fan Top Double Pedestal Desk, Box/Box/File Left and Right  
(Full modesty, H3B handles, 2 locks)

Model#	Depth	Width	Height	Weight	Cube	Price
☞ MCFDC3672	30-36"	72"	29"	335	45	\$3,462
☞ MCFDC4272	36-42"	72"	29"	350	53	\$3,482

For left Box/Box/File and right File/File configuration use MCFDCD\_\_\_\_\_ at no charge.

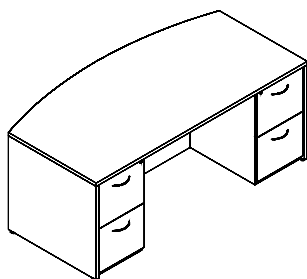

Fan Top Double Pedestal Desk, File/File Left and Right  
(Full modesty, H3B handles, 2 locks)

Model#	Depth	Width	Height	Weight	Cube	Price
☞ MCFDD3672	30-36"	72"	29"	335	45	\$3,337
☞ MCFDD4272	36-42"	72"	29"	350	53	\$3,356

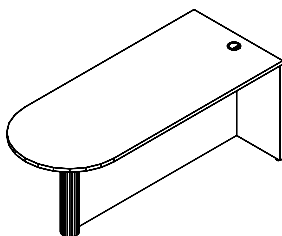

Bullet Desk, (Full modesty, 4" black post, centered black grommet) For Right Return

Model#	Depth	Width	Height	Weight	Cube	Price
☞ MCBD3060R	30"	60"	29"	180	32	\$1,407
☞ MCBD3072R	30"	72"	29"	195	35	\$1,588
☞ MCBD3660R	36"	60"	29"	185	38	\$1,588
☞ MCBD3672R	36"	72"	29"	205	45	\$1,678

For silver post upgrade, add at no charge. Upgrade grommet cover to silver at no charge.  
Note: Specify if standalone. Standalone Bullet Desk is made with ½ leg (MMSPT) at no charge, replaces post leg.

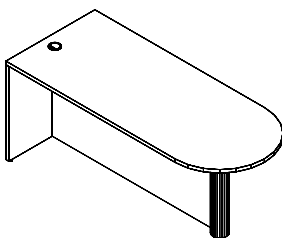

Bullet Desk, (Full modesty, 4" black post, centered black grommet) For Left Return

Model#	Depth	Width	Height	Weight	Cube	Price
☞ MCBD3060L	30"	60"	29"	180	32	\$1,407
☞ MCBD3072L	30"	72"	29"	195	35	\$1,588
☞ MCBD3660L	36"	60"	29"	185	38	\$1,588
☞ MCBD3672L	36"	72"	29"	205	45	\$1,678

For silver post upgrade, add at no charge. Upgrade grommet cover to silver at no charge.  
Note: Specify if standalone. Standalone Bullet Desk is made with ½ leg (MMSPT) at no charge, replaces post leg.

For available accessories and upgrades, see pages 56–59.

# maverick series

## Desks

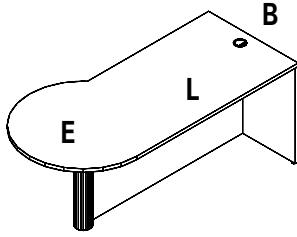

P-Shape Desk (Full modesty, 4" black post) For Right Return

Model#	Depth (B,E)	Width (L)	Height	Weight	Cube	Price
MCPBD3072R	30/36"	72"	29"	200	45	\$1,895
MCPBD3672R	36/42"	72"	29"	205	53	\$1,985
MCPBD3678R	36/42"	78"	29"	215	49	\$2,146
MCPBD3684R	36/42"	84"	29"	225	62	\$2,453

Black grommet standard. Upgrade grommet cover to silver at no charge.  
For silver post upgrade, add at no charge.

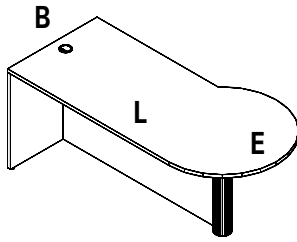

P-Shape Desk (Full modesty, 4" black post) For Left Return

Model#	Depth (B,E)	Width (L)	Height	Weight	Cube	Price
MCPBD3072L	30/36"	72"	29"	200	45	\$1,895
MCPBD3672L	36/42"	72"	29"	205	53	\$1,985
MCPBD3678L	36/42"	78"	29"	215	49	\$2,146
MCPBD3684L	36/42"	84"	29"	225	62	\$2,453

Black grommet standard. Upgrade grommet cover to silver at no charge.  
For silver post upgrade, add at no charge.

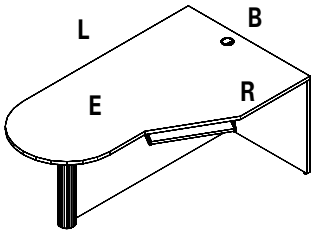

Bullet Computer Desk (Full modesty, 4" black post) For Right Return

Model#	Depth (B,E)	Width (L,R)	Height	Weight	Cube	Price
☞ MCBDC427230R	42/30"	72"/24"	29"	195	53	\$1,711
☞ MCBDC427830R	42/30"	78"/24"	29"	205	58	\$2,071

Keyboard tray and worksurface black grommet are standard. Upgrade grommet cover to silver at no charge. For silver post upgrade, add at no charge.

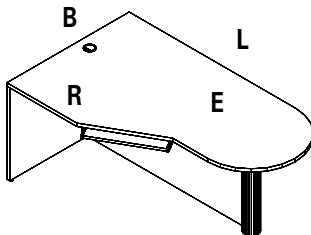

Bullet Computer Desk (Full modesty, 4" black post) For Left Return

Model#	Depth (B,E)	Width (L,R)	Height	Weight	Cube	Price
☞ MCBDC427230L	42/30"	72"/24"	29"	195	53	\$1,711
☞ MCBDC427830L	42/30"	78"/24"	29"	205	58	\$2,071

Keyboard tray and worksurface black grommet are standard. Upgrade grommet cover to silver at no charge. For silver post upgrade, add at no charge.

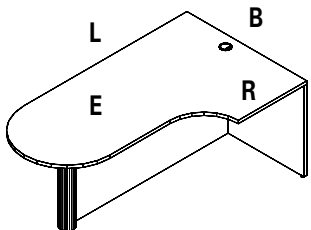

Bullet Computer Desk, Curved (Full modesty, 4" black post) For Right Return

Model#	Depth (B,E)	Width (L,R)	Height	Weight	Cube	Price
☞ MCBDCQ427230R	42/30"	72"/24"	29"	195	53	\$1,711

Worksurface black grommet standard. Upgrade grommet cover to silver at no charge.  
For silver post upgrade, add at no charge.

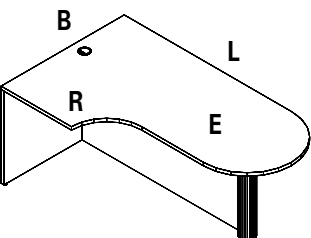

Bullet Computer Desk, Curved (Full modesty, 4" black post) For Left Return

Model#	Depth (B,E)	Width (L,R)	Height	Weight	Cube	Price
☞ MCBDCQ427230L	42/30"	72"/24"	29"	195	53	\$1,711

Worksurface black grommet standard. Upgrade grommet cover to silver at no charge.  
For silver post upgrade, add at no charge.

**NOTE:** For all P-shape bullet & bullet computer desks, specify if standalone.  
Standalone is made with 1/2 leg (MMSPT) at no charge, replaces post leg.

For available accessories and upgrades, see pages 56–59.

# maverick series

## Desks

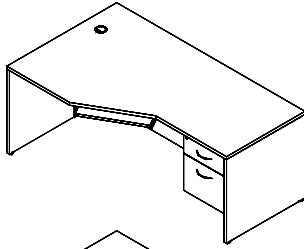

Computer Desk, Box/File Pedestal Right (Full modesty inset 6", H3B handles, lock)

Model	(L)	(B)	(E)	(K)	(R)	(W)	Weight	Cube	Price
MCCD72 9R	72"	42"	30"	24"	24"	27"	285	45	\$2,426

Keyboard tray & worksurface black grommet are standard. Upgrade grommet cover to silver at no charge.

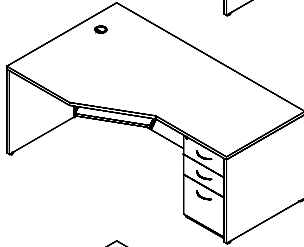

Computer Desk, Box/Box/File Pedestal Right (Full modesty inset 6", H3B handles, lock)

Model	(L)	(B)	(E)	(K)	(R)	(W)	Weight	Cube	Price
MCCD72C 9R	72"	42"	30"	24"	24"	27"	300	45	\$3,053

Keyboard tray & worksurface black grommet are standard. Upgrade grommet cover to silver at no charge.

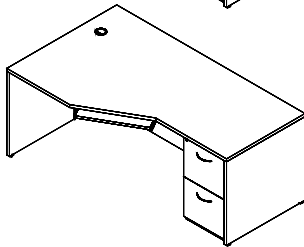

Computer Desk, File/File Pedestal Right (Full modesty inset 6", H3B handles, lock)

Model	(L)	(B)	(E)	(K)	(R)	(W)	Weight	Cube	Price
MCCD72D 9R	72"	42"	30"	24"	24"	27"	300	45	\$2,962

Keyboard tray & worksurface black grommet are standard. Upgrade grommet cover to silver at no charge.

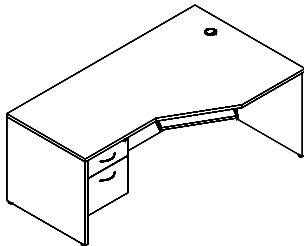

Computer Desk, Box/File Pedestal Left (Full modesty inset 6", H3B handles, lock)

Model	(L)	(B)	(E)	(K)	(R)	(W)	Weight	Cube	Price
MCCD72 9L	72"	42"	30"	24"	24"	27"	285	45	\$2,426

Keyboard tray & worksurface black grommet are standard. Upgrade grommet cover to silver at no charge.

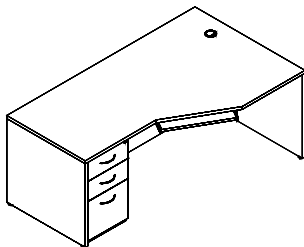

Computer Desk, Box/Box/File Pedestal Left (Full modesty inset 6", H3B handles, lock)

Model	(L)	(B)	(E)	(K)	(R)	(W)	Weight	Cube	Price
MCCD72C 9L	72"	42"	30"	24"	24"	27"	300	45	\$3,053

Keyboard tray & worksurface black grommet are standard. Upgrade grommet cover to silver at no charge.

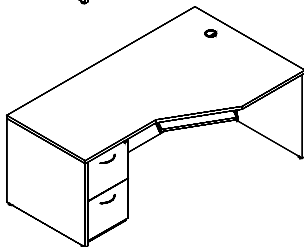

Computer Desk, File/File Pedestal Left (Full modesty inset 6", H3B handles, lock)

Model	(L)	(B)	(E)	(K)	(R)	(W)	Weight	Cube	Price
MCCD72D 9L	72"	42"	30"	24"	24"	27"	300	45	\$2,962

Keyboard tray & worksurface black grommet are standard. Upgrade grommet cover to silver at no charge.

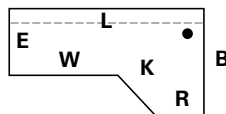

- "L" Length along approach edge
- "B" Back end panel
- "E" End panel
- "K" Keyboard space
- "R" Return size to attach
- "W" Workarea (kbrd to end)

For available accessories and upgrades, see pages 56–59.



# maverick series

## Desks

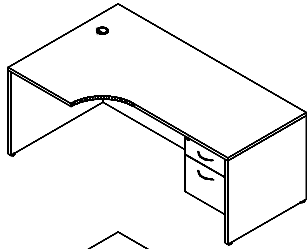

**Computer Desk, Curved, Box/File Pedestal Right**  
(Full modesty inset 6", H3B handles, lock)

Model	(L)	(B)	(E)	(K)	(R)	(W)	Weight	Cube	Price
MCCDQ72 9R	72"	42"	30"	24"	24"	27"	285	45	\$2,426

No keyboard tray. Worksurface black grommet standard. Upgrade grommet cover to silver at no charge.

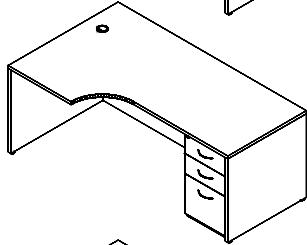

**Computer Desk, Curved, Box/Box/File Pedestal Right**  
(Full modesty inset 6", H3B handles, lock)

Model	(L)	(B)	(E)	(K)	(R)	(W)	Weight	Cube	Price
MCCDQ72C 9R	72"	42"	30"	24"	24"	27"	300	45	\$3,053

No keyboard tray. Worksurface black grommet standard. Upgrade grommet cover to silver at no charge.

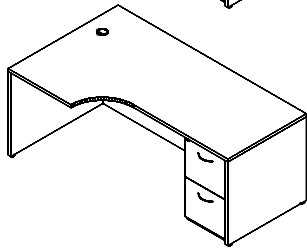

**Computer Desk, Curved, File/File Pedestal Right**  
(Full modesty inset 6", H3B handles, lock)

Model	(L)	(B)	(E)	(K)	(R)	(W)	Weight	Cube	Price
MCCDQ72D 9R	72"	42"	30"	24"	24"	27"	300	45	\$2,962

No keyboard tray. Worksurface black grommet standard. Upgrade grommet cover to silver at no charge.

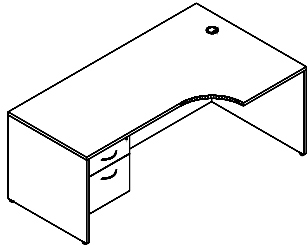

**Computer Desk, Curved, Box/File Pedestal Left**  
(Full modesty inset 6", H3B handles, lock)

Model	(L)	(B)	(E)	(K)	(R)	(W)	Weight	Cube	Price
MCCDQ72 9L	72"	42"	30"	24"	24"	27"	285	45	\$2,426

No keyboard tray. Worksurface black grommet standard. Upgrade grommet cover to silver at no charge.

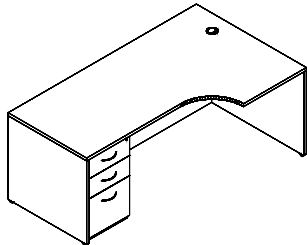

**Computer Desk, Curved, Box/Box/File Pedestal Left**  
(Full modesty inset 6", H3B handles, lock)

Model	(L)	(B)	(E)	(K)	(R)	(W)	Weight	Cube	Price
MCCDQ72C 9L	72"	42"	30"	24"	24"	27"	300	45	\$3,053

No keyboard tray. Worksurface black grommet standard. Upgrade grommet cover to silver at no charge.

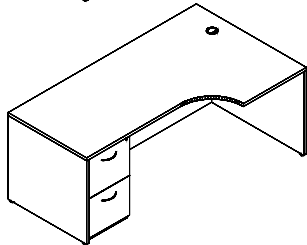

**Computer Desk, Curved, File/File Pedestal Left**  
(Full modesty inset 6", H3B handles, lock)

Model	(L)	(B)	(E)	(K)	(R)	(W)	Weight	Cube	Price
MCCDQ72D 9L	72"	42"	30"	24"	24"	27"	300	45	\$2,962

No keyboard tray. Worksurface black grommet standard. Upgrade grommet cover to silver at no charge.

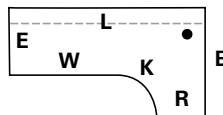

- "L" Length along approach edge
- "B" Back end panel
- "E" End panel
- "K" Keyboard space
- "R" Return size to attach
- "W" Workarea (kbrd to end)

For available accessories and upgrades, see pages 56–59.

# maverick series

## Desks

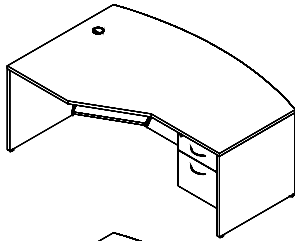

**Fan Top Computer Desk, Box/File Pedestal Right**  
(Full modesty inset 6", H3B handles, lock)

Model	(L)	(B)	(E)	(K)	(R)	(W)	Weight	Cube	Price
MCFC72 9R	72"	42"+	30"	24"	24"	27"	295	48	\$2,594

Fan front adds 6" to overall depth. Keyboard tray and worksurface black grommet are standard. Upgrade grommet cover to silver at no charge.

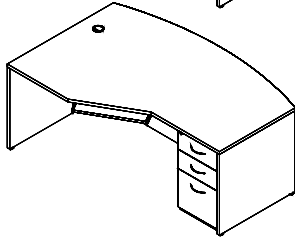

**Fan Top Computer Desk, Box/Box/File Pedestal Right**  
(Full modesty inset 6", H3B handles, lock)

Model	(L)	(B)	(E)	(K)	(R)	(W)	Weight	Cube	Price
MCFC72C 9R	72"	42"+	30"	24"	24"	27"	310	48	\$3,224

Fan front adds 6" to overall depth. Keyboard tray and worksurface black grommet are standard. Upgrade grommet cover to silver at no charge.

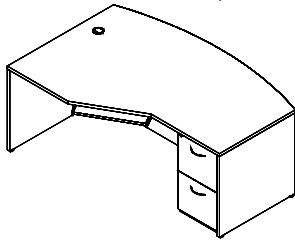

**Fan Top Computer Desk, File/File Pedestal Right**  
(Full modesty inset 6", H3B handles, lock)

Model	(L)	(B)	(E)	(K)	(R)	(W)	Weight	Cube	Price
MCFC72D 9R	72"	42"+	30"	24"	24"	27"	310	48	\$3,130

Fan front adds 6" to overall depth. Keyboard tray and worksurface black grommet are standard. Upgrade grommet cover to silver at no charge.

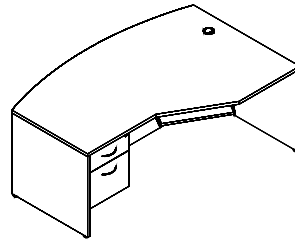

**Fan Top Computer Desk, Box/File Pedestal Left**  
(Full modesty inset 6", H3B handles, lock)

Model	(L)	(B)	(E)	(K)	(R)	(W)	Weight	Cube	Price
MCFC72 9L	72"	42"+	30"	24"	24"	27"	295	48	\$2,594

Fan front adds 6" to overall depth. Keyboard tray and worksurface black grommet are standard. Upgrade grommet cover to silver at no charge.

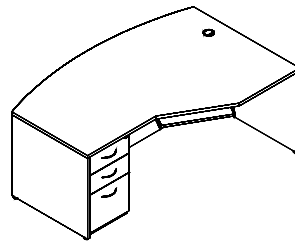

**Fan Top Computer Desk, Box/Box/File Pedestal Left**  
(Full modesty inset 6", H3B handles, lock)

Model	(L)	(B)	(E)	(K)	(R)	(W)	Weight	Cube	Price
MCFC72C 9L	72"	42"+	30"	24"	24"	27"	310	48	\$3,224

Fan front adds 6" to overall depth. Keyboard tray and worksurface black grommet are standard. Upgrade grommet cover to silver at no charge.

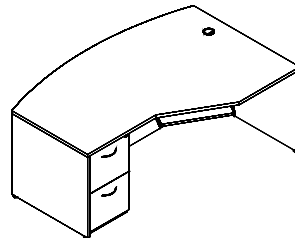

**Fan Top Computer Desk, File/File Pedestal Left**  
(Full modesty inset 6", H3B handles, lock)

Model	(L)	(B)	(E)	(K)	(R)	(W)	Weight	Cube	Price
MCFC72D 9L	72"	42"+	30"	24"	24"	27"	310	48	\$3,130

Fan front adds 6" to overall depth. Keyboard tray and worksurface black grommet are standard. Upgrade grommet cover to silver at no charge.

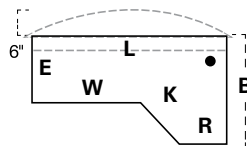

- "L" Length along approach edge
- "B" Back end panel (Fan top adds 6")
- "E" End panel
- "K" Keyboard space
- "R" Return size to attach
- "W" Workarea (kbrd to end)

For available accessories and upgrades, see pages 56–59.

# maverick series

## Desks

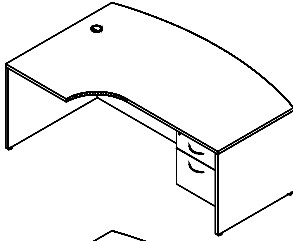

**Fan Top Computer Desk, Curved, Box/File Pedestal Right**  
(Full modesty inset 6", H3B handles, lock)

Model	(L)	(B)	(E)	(K)	(R)	(W)	Weight	Cube	Price
MCFCDDQ72 9R	72"	42"+	30"	24"	24"	27"	295	48	\$2,594

Fan front adds 6" to overall depth. No keyboard tray. Worksurface black grommet standard. Upgrade grommet cover to silver at no charge.

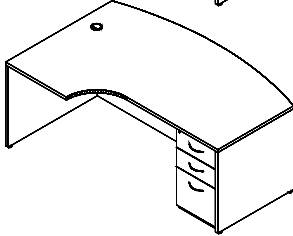

**Fan Top Computer Desk, Curved, Box/Box/File Pedestal Right**  
(Full modesty inset 6", H3B handles, lock)

Model	(L)	(B)	(E)	(K)	(R)	(W)	Weight	Cube	Price
MCFCDDQ72C 9R	72"	42"+	30"	24"	24"	27"	310	48	\$3,224

Fan front adds 6" to overall depth. No keyboard tray. Worksurface black grommet standard. Upgrade grommet cover to silver at no charge.

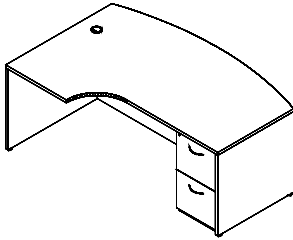

**Fan Top Computer Desk, Curved, File/File Pedestal Right**  
(Full modesty inset 6", H3B handles, lock)

Model	(L)	(B)	(E)	(K)	(R)	(W)	Weight	Cube	Price
MCFCDDQ72D 9R	72"	42"+	30"	24"	24"	27"	310	48	\$3,130

Fan front adds 6" to overall depth. No keyboard tray. Worksurface black grommet standard. Upgrade grommet cover to silver at no charge.

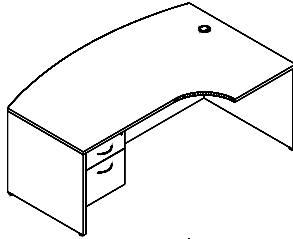

**Fan Top Computer Desk, Curved, Box/File Pedestal Left**  
(Full modesty inset 6", H3B handles, lock)

Model	(L)	(B)	(E)	(K)	(R)	(W)	Weight	Cube	Price
MCFCDDQ72 9L	72"	42"+	30"	24"	24"	27"	295	48	\$2,594

Fan front adds 6" to overall depth. No keyboard tray. Worksurface black grommet standard. Upgrade grommet cover to silver at no charge.

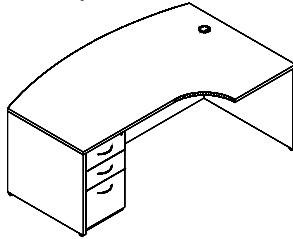

**Fan Top Computer Desk, Curved, Box/Box/File Pedestal Left**  
(Full modesty inset 6", H3B handles, lock)

Model	(L)	(B)	(E)	(K)	(R)	(W)	Weight	Cube	Price
MCFCDDQ72C 9L	72"	42"+	30"	24"	24"	27"	310	48	\$3,224

Fan front adds 6" to overall depth. No keyboard tray. Worksurface black grommet standard. Upgrade grommet cover to silver at no charge.

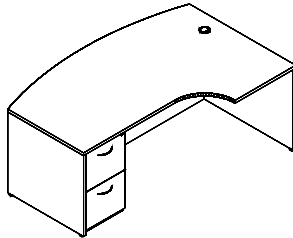

**Fan Top Computer Desk, Curved, File/File Pedestal Left**  
(Full modesty inset 6", H3B handles, lock)

Model	(L)	(B)	(E)	(K)	(R)	(W)	Weight	Cube	Price
MCFCDDQ72D 9L	72"	42"+	30"	24"	24"	27"	310	48	\$3,130

Fan front adds 6" to overall depth. No keyboard tray. Worksurface black grommet standard. Upgrade grommet cover to silver at no charge.

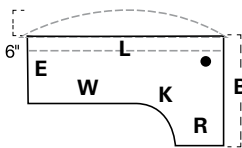

- "L" Length along approach edge
- "B" Back end panel (Fan top adds 6")
- "E" End panel
- "K" Keyboard space
- "R" Return size to attach
- "W" Workarea (kbrd to end)

For available accessories and upgrades, see pages 56–59.

# maverick series

## Desks

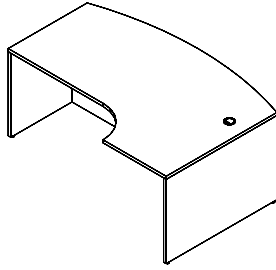

### Fan Top Computer Desk Shell, Curved (Full modesty inset 6") For Right Return

Model	(L)	(B)	(E)	(K)	(R)	(W)	Weight	Cube	Price
MCFCDNQ72 9R	72"	42"+	30"	24"	24"	27"	215	48	\$1,957

Fan front adds 6" to overall depth. No keyboard tray. Worksurface black grommet standard. Upgrade grommet cover to silver at no charge.

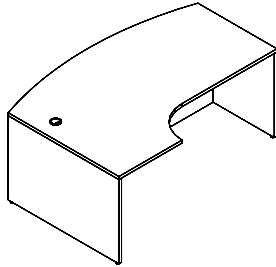

### Fan Top Computer Desk Shell, Curved (Full modesty inset 6") For Left Return

Model	(L)	(B)	(E)	(K)	(R)	(W)	Weight	Cube	Price
MCFCDNQ72 9L	72"	42"+	30"	24"	24"	27"	215	48	\$1,957

Fan front adds 6" to overall depth. No keyboard tray. Worksurface black grommet standard. Upgrade grommet cover to silver at no charge.

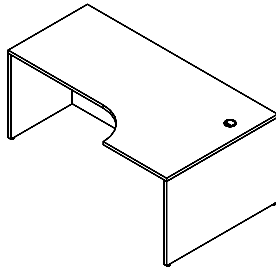

### Computer Desk Shell, Curved (Full modesty inset 6") For Right Return

Model#	(L)	(B)	(E)	(K)	(R)	(W)	Weight	Cube	Price
MCCDNQ72 9R	72"	42"	30"	24"	24"	27"	215	51	\$1,957

No keyboard tray. Worksurface black grommet standard. Upgrade grommet cover to silver at no charge.

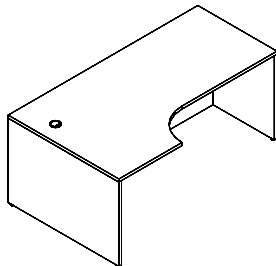

### Computer Desk Shell, Curved (Full modesty inset 6") For Left Return

Model#	(L)	(B)	(E)	(K)	(R)	(W)	Weight	Cube	Price
MCCDNQ72 9L	72"	42"	30"	24"	24"	27"	215	51	\$1,957

No keyboard tray. Worksurface black grommet standard. Upgrade grommet cover to silver at no charge.

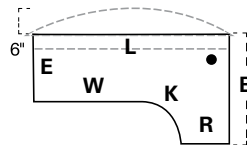

- "L" Length along approach edge
- "B" Back end panel (Fan top adds 6")
- "E" End panel
- "K" Keyboard space
- "R" Return size to attach
- "W" Workarea (kbrd to end)

# maverick series

## Bridges

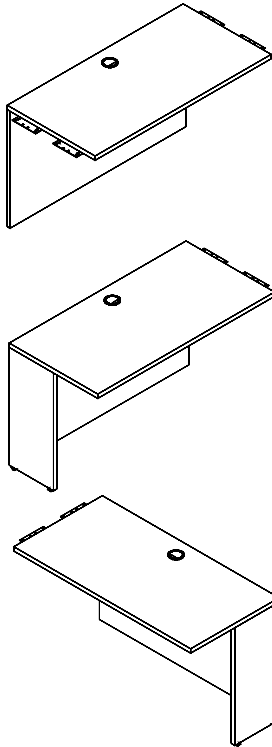

### Bridge (Full modesty)

Model#	Depth	Width	Height	Weight	Cube	Price
MCBR2036	20"	36"	29"	41	9	\$621
MCBR2042	20"	42"	29"	48	10	\$645
MCBR2048	20"	48"	29"	55	12	\$716
MCBR2436	24"	36"	29"	47	10	\$671
MCBR2442	24"	42"	29"	55	12	\$785
MCBR2448	24"	48"	29"	63	14	\$851

### Right Bridge, Left 1/2 Leg (Full modesty)

Model#	Depth	Width	Height	Weight	Cube	Price
MCHABR2436R	24"	36"	29"	47	10	\$766
MCHABR2442R	24"	42"	29"	55	12	\$882
MCHABR2448R	24"	48"	29"	63	14	\$947

### Left Bridge, Right 1/2 Leg (Full modesty)

Model#	Depth	Width	Height	Weight	Cube	Price
MCHABR2436L	24"	36"	29"	47	10	\$766
MCHABR2442L	24"	42"	29"	55	12	\$882
MCHABR2448L	24"	48"	29"	63	14	\$947

Full modesty standard. 1/2 modesty on bridges may be specified at no upcharge. Black grommet center top and modesty. Upgrade grommet cover to silver at no charge.

## Returns

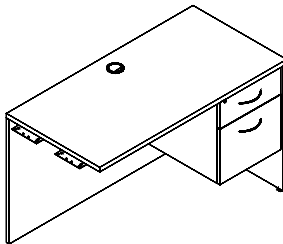

### Return, 3/4 Box/File Pedestal Right (Full modesty, H3B handles, lock)

Model#	Depth	Width	Height	Weight	Cube	Price
MCRA2036R	20"	36"	29"	95	13	\$1,425
MCRA2042R	20"	42"	29"	104	15	\$1,445
MCRA2048R	20"	48"	29"	110	17	\$1,471
MCRA2054R	20"	54"	29"	117	19	\$1,514
MCRA2436R	24"	36"	29"	100	15	\$1,577
MCRA2442R	24"	42"	29"	107	18	\$1,620
MCRA2448R	24"	48"	29"	114	20	\$1,642
MCRA2454R	24"	54"	29"	121	23	\$1,735
MCRA2460R	24"	60"	29"	124	24	\$1,758
MCRA3048R	30"	48"	29"	127	25	\$1,758

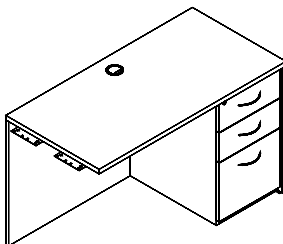

### Return, Box/Box/File Pedestal Right (Full modesty, H3B handles, lock)

Model#	Depth	Width	Height	Weight	Cube	Price
MCRC2036R	20"	36"	29"	130	13	\$2,060
MCRC2042R	20"	42"	29"	140	15	\$2,081
MCRC2048R	20"	48"	29"	150	17	\$2,107
MCRC2054R	20"	54"	29"	160	19	\$2,153
MCRC2436R	24"	36"	29"	140	15	\$2,208
MCRC2442R	24"	42"	29"	150	18	\$2,256
MCRC2448R	24"	48"	29"	160	20	\$2,276
MCRC2454R	24"	54"	29"	170	23	\$2,370
MCRC2460R	24"	60"	29"	180	24	\$2,389
MCRC3048R	30"	48"	29"	175	25	\$2,389

Full modesty standard. 1/2 modesty on returns may be specified at no upcharge. Black grommet center top and modesty. Upgrade grommet cover to silver at no charge.

For available accessories and upgrades, see pages 56–59.

# maverick series

## Returns

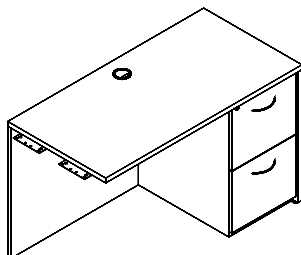

Return, File/File Pedestal Right (Full modesty, H3B handles, lock)

Model#	Depth	Width	Height	Weight	Cube	Price
☞ MCRD2036R	20"	36"	29"	130	13	\$1,962
☞ MCRD2042R	20"	42"	29"	140	15	\$1,985
☞ MCRD2048R	20"	48"	29"	150	17	\$2,009
☞ MCRD2054R	20"	54"	29"	160	19	\$2,056
☞ MCRD2436R	24"	36"	29"	140	15	\$2,116
☞ MCRD2442R	24"	42"	29"	150	18	\$2,132
☞ MCRD2448R	24"	48"	29"	160	20	\$2,180
☞ MCRD2454R	24"	54"	29"	170	23	\$2,277
☞ MCRD2460R	24"	60"	29"	180	24	\$2,292
☞ MCRD3048R	30"	48"	29"	175	25	\$2,292

Full modesty standard. ½ modesty on returns may be specified at no upcharge.  
Black grommet center top and modesty. Upgrade grommet cover to silver at no charge.

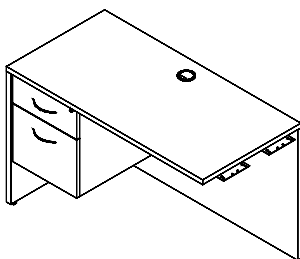

Return, ¾ Box/File Pedestal Left (Full modesty, H3B handles, lock)

Model#	Depth	Width	Height	Weight	Cube	Price
☞ MCRA2036L	20"	36"	29"	95	13	\$1,425
☞ MCRA2042L	20"	42"	29"	104	15	\$1,445
☞ MCRA2048L	20"	48"	29"	110	17	\$1,471
☞ MCRA2054L	20"	54"	29"	117	19	\$1,514
☞ MCRA2436L	24"	36"	29"	100	15	\$1,577
☞ MCRA2442L	24"	42"	29"	107	18	\$1,620
☞ MCRA2448L	24"	48"	29"	114	20	\$1,642
☞ MCRA2454L	24"	54"	29"	121	23	\$1,735
☞ MCRA2460L	24"	60"	29"	124	24	\$1,758
☞ MCRA3048L	30"	48"	29"	127	25	\$1,758

Full modesty standard. ½ modesty on returns may be specified at no upcharge.  
Black grommet center top and modesty. Upgrade grommet cover to silver at no charge.

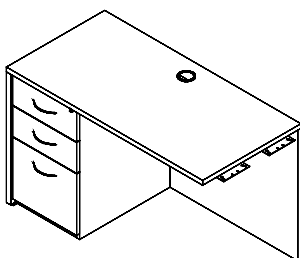

Return, Box/Box/File Pedestal Left (Full modesty, H3B handles, lock)

Model#	Depth	Width	Height	Weight	Cube	Price
☞ MCRC2036L	20"	36"	29"	130	13	\$2,060
☞ MCRC2042L	20"	42"	29"	140	15	\$2,081
☞ MCRC2048L	20"	48"	29"	150	17	\$2,107
☞ MCRC2054L	20"	54"	29"	160	19	\$2,153
☞ MCRC2436L	24"	36"	29"	140	15	\$2,208
☞ MCRC2442L	24"	42"	29"	150	18	\$2,256
☞ MCRC2448L	24"	48"	29"	160	20	\$2,276
☞ MCRC2454L	24"	54"	29"	170	23	\$2,370
☞ MCRC2460L	24"	60"	29"	180	24	\$2,389
☞ MCRC3048L	30"	48"	29"	175	25	\$2,389

Full modesty standard. ½ modesty on returns may be specified at no upcharge.  
Black grommet center top and modesty. Upgrade grommet cover to silver at no charge.

For available accessories and upgrades, see pages 56–59.

# maverick series

## Returns

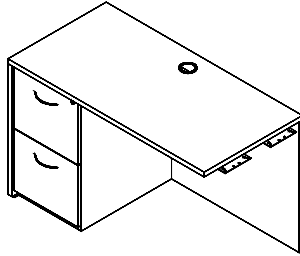

Return, File/File Pedestal Left (Full modesty, H3B handles, lock)

Model#	Depth	Width	Height	Weight	Cube	Price
☞ MCRD2036L	20"	36"	29"	130	13	\$1,962
☞ MCRD2042L	20"	42"	29"	140	15	\$1,985
☞ MCRD2048L	20"	48"	29"	150	17	\$2,009
☞ MCRD2054L	20"	54"	29"	160	19	\$2,056
☞ MCRD2436L	24"	36"	29"	140	15	\$2,116
☞ MCRD2442L	24"	42"	29"	150	18	\$2,132
☞ MCRD2448L	24"	48"	29"	160	20	\$2,180
☞ MCRD2454L	24"	54"	29"	170	23	\$2,277
☞ MCRD2460L	24"	60"	29"	180	24	\$2,292
☞ MCRD3048L	30"	48"	29"	175	25	\$2,292

Full modesty standard. ½ modesty on returns may be specified at no upcharge.  
Black grommet center top and modesty. Upgrade grommet cover to silver at no charge.

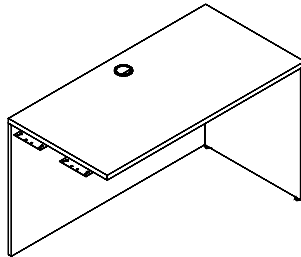

Return Shell Right (Full modesty)

Model#	Depth	Width	Height	Weight	Cube	Price
☞ MCRN2036R	20"	36"	29"	60	13	\$785
☞ MCRN2042R	20"	42"	29"	67	15	\$807
☞ MCRN2048R	20"	48"	29"	73	17	\$884
☞ MCRN2054R	20"	54"	29"	80	19	\$957
☞ MCRN2436R	24"	36"	29"	63	15	\$968
☞ MCRN2442R	24"	42"	29"	67	18	\$1,012
☞ MCRN2448R	24"	48"	29"	74	20	\$1,062
☞ MCRN2454R	24"	54"	29"	80	23	\$1,114
☞ MCRN3048R	30"	48"	29"	89	25	\$1,181

Full modesty standard. ½ modesty on returns may be specified at no upcharge.  
Black grommet center top and modesty. Upgrade grommet cover to silver at no charge.

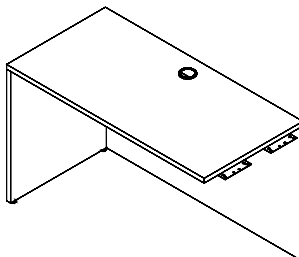

Return Shell Left (Full modesty)

Model#	Depth	Width	Height	Weight	Cube	Price
☞ MCRN2036L	20"	36"	29"	60	13	\$785
☞ MCRN2042L	20"	42"	29"	67	15	\$807
☞ MCRN2048L	20"	48"	29"	73	17	\$884
☞ MCRN2054L	20"	54"	29"	80	19	\$957
☞ MCRN2436L	24"	36"	29"	63	15	\$968
☞ MCRN2442L	24"	42"	29"	67	18	\$1,012
☞ MCRN2448L	24"	48"	29"	74	20	\$1,062
☞ MCRN2454L	24"	54"	29"	80	23	\$1,114
☞ MCRN3048L	30"	48"	29"	89	25	\$1,181

Full modesty standard. ½ modesty on returns may be specified at no upcharge.  
Black grommet center top and modesty. Upgrade grommet cover to silver at no charge.

# maverick series

## Returns

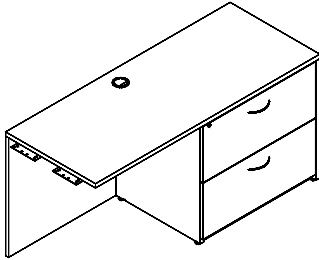

Return, Right 31" Lateral File (H3B handles, lock, full modesty)

Model#	Depth	Width	Height	Weight	Cube	Price
MCRLF2054R	20"	54"	29"	192	19	\$2,293
MCRLF2060R	20"	60"	29"	198	21	\$2,311
MCRLF2454R	24"	54"	29"	201	23	\$2,400
MCRLF2460R	24"	60"	29"	208	25	\$2,461

**Black grommet center top and modesty. Upgrade grommet cover to silver at no charge.**

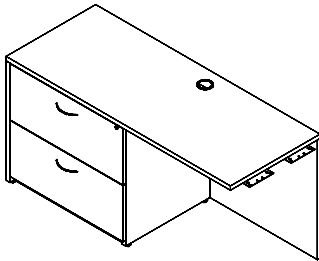

Return, Left 31" Lateral File (H3B handles, lock, full modesty)

Model#	Depth	Width	Height	Weight	Cube	Price
MCRLF2054L	20"	54"	29"	192	19	\$2,293
MCRLF2060L	20"	60"	29"	198	21	\$2,311
MCRLF2454L	24"	54"	29"	201	23	\$2,400
MCRLF2460L	24"	60"	29"	208	25	\$2,461

**Black grommet center top and modesty. Upgrade grommet cover to silver at no charge.**

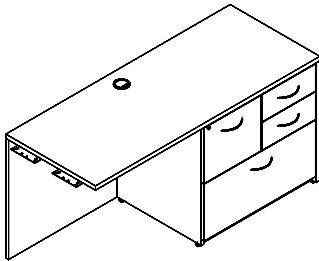

Return, Right 31" Personal Lateral File (H3B handles, lock, full modesty)

Model#	Depth	Width	Height	Weight	Cube	Price
MCRPLF2054R	20"	54"	29"	195	19	\$2,476
MCRPLF2060R	20"	60"	29"	201	23	\$2,557
MCRPLF2454R	24"	54"	29"	205	23	\$2,503
MCRPLF2460R	24"	60"	29"	213	28	\$2,606

**Box drawers do not lock. 1 Lock — locks file & lateral file drawer. Black grommet center top and modesty. Upgrade grommet cover to silver at no charge.**

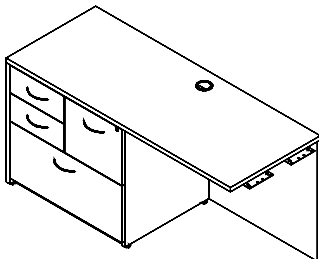

Return, Left 31" Personal Lateral File (H3B handles, lock, full modesty)

Model#	Depth	Width	Height	Weight	Cube	Price
MCRPLF2054L	20"	54"	29"	195	19	\$2,476
MCRPLF2060L	20"	60"	29"	201	23	\$2,557
MCRPLF2454L	24"	54"	29"	205	23	\$2,503
MCRPLF2460L	24"	60"	29"	213	28	\$2,606

**Box drawers do not lock. 1 Lock — locks file & lateral file drawer. Black grommet center top and modesty. Upgrade grommet cover to silver at no charge.**

For available accessories and upgrades, see pages 56–59.



## maverick series

## Freestanding Returns

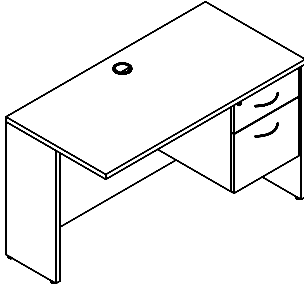

Freestanding Return Full Modesty Right Box/File, Left Half Leg (H3B handles, lock)

Model#	Depth	Width	Height	Weight	Cube	Price
MCHARA2036R	20"	36"	29"	95	13	\$2,059
MCHARA2042R	20"	42"	29"	104	15	\$2,081
MCHARA2048R	20"	48"	29"	110	17	\$2,106
MCHARA2054R	20"	54"	29"	117	19	\$2,152
MCHARA2436R	24"	36"	29"	100	15	\$2,213
MCHARA2442R	24"	42"	29"	107	18	\$2,228
MCHARA2448R	24"	48"	29"	114	20	\$2,277
MCHARA2454R	24"	54"	29"	121	23	\$2,372
MCHARA2460R	24"	60"	29"	124	24	\$2,389
MCHARA3048R	30"	48"	29"	127	25	\$2,389

Note: Full Modesty is standard. ½ or ¾ modesty may be specified add MMCUT1 \$150.  
Black grommet center top and modesty. Upgrade grommet cover to silver at no charge.

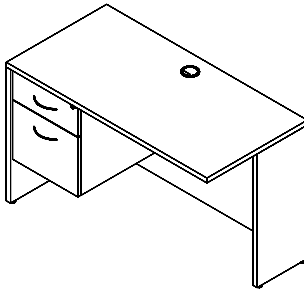

Freestanding Return Full Modesty Left Box/File, Right Half Leg (H3B handles, lock)

Model#	Depth	Width	Height	Weight	Cube	Price
MCHARA2036L	20"	36"	29"	95	13	\$2,059
MCHARA2042L	20"	42"	29"	104	15	\$2,081
MCHARA2048L	20"	48"	29"	110	17	\$2,106
MCHARA2054L	20"	54"	29"	117	19	\$2,152
MCHARA2436L	24"	36"	29"	100	15	\$2,213
MCHARA2442L	24"	42"	29"	107	18	\$2,228
MCHARA2448L	24"	48"	29"	114	20	\$2,277
MCHARA2454L	24"	54"	29"	121	23	\$2,372
MCHARA2460L	24"	60"	29"	124	24	\$2,389
MCHARA3048L	30"	48"	29"	127	25	\$2,389

Note: Full Modesty is standard. ½ or ¾ modesty may be specified add MMCUT1 \$150.  
Black grommet center top and modesty. Upgrade grommet cover to silver at no charge.

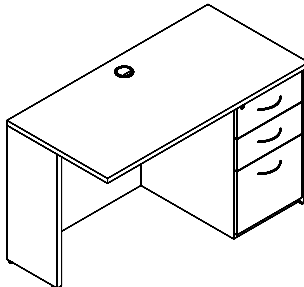

Freestanding Return Full Modesty Right Box/Box/File, Left Half Leg (H3B handles, lock)

Model#	Depth	Width	Height	Weight	Cube	Price
MCHARC2036R	20"	36"	29"	130	13	\$2,156
MCHARC2042R	20"	42"	29"	140	15	\$2,178
MCHARC2048R	20"	48"	29"	150	17	\$2,204
MCHARC2054R	20"	54"	29"	160	19	\$2,250
MCHARC2436R	24"	36"	29"	140	15	\$2,305
MCHARC2442R	24"	42"	29"	150	18	\$2,352
MCHARC2448R	24"	48"	29"	160	20	\$2,371
MCHARC2454R	24"	54"	29"	170	23	\$2,467
MCHARC2460R	24"	60"	29"	180	24	\$2,486
MCHARC3048R	30"	48"	29"	175	25	\$2,486

Note: Full Modesty is standard. ½ or ¾ modesty may be specified add MMCUT1 \$150.  
Black grommet center top and modesty. Upgrade grommet cover to silver at no charge.

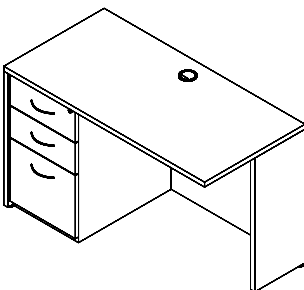

Freestanding Return Full Modesty Left Box/Box/File, Right Half Leg (H3B handles, lock)

Model#	Depth	Width	Height	Weight	Cube	Price
MCHARC2036L	20"	36"	29"	130	13	\$2,156
MCHARC2042L	20"	42"	29"	140	15	\$2,178
MCHARC2048L	20"	48"	29"	150	17	\$2,204
MCHARC2054L	20"	54"	29"	160	19	\$2,250
MCHARC2436L	24"	36"	29"	140	15	\$2,305
MCHARC2442L	24"	42"	29"	150	18	\$2,352
MCHARC2448L	24"	48"	29"	160	20	\$2,371
MCHARC2454L	24"	54"	29"	170	23	\$2,467
MCHARC2460L	24"	60"	29"	180	24	\$2,486
MCHARC3048L	30"	48"	29"	175	25	\$2,486

Note: Full Modesty is standard. ½ or ¾ modesty may be specified add MMCUT1 \$150.  
Black grommet center top and modesty. Upgrade grommet cover to silver at no charge.

# maverick series

## Freestanding Returns

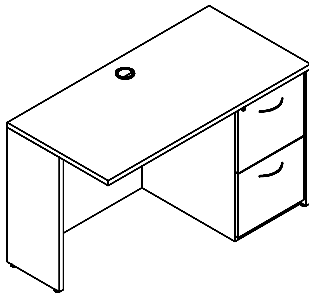

Freestanding Return Full Modesty Right File/File, Left Half Leg (H3B handles, lock)

Model#	Depth	Width	Height	Weight	Cube	Price
MCHARD2036R	20"	36"	29"	130	13	\$2,059
MCHARD2042R	20"	42"	29"	140	15	\$2,081
MCHARD2048R	20"	48"	29"	150	17	\$2,106
MCHARD2054R	20"	54"	29"	160	19	\$2,152
MCHARD2436R	24"	36"	29"	140	15	\$2,213
MCHARD2442R	24"	42"	29"	150	18	\$2,228
MCHARD2448R	24"	48"	29"	160	20	\$2,277
MCHARD2454R	24"	54"	29"	170	23	\$2,372
MCHARD2460R	24"	60"	29"	180	24	\$2,389
MCHARD3048R	30"	48"	29"	175	25	\$2,389

Note: Full Modesty is standard. ½ or ¾ modesty may be specified add MMCUT1 \$150. Black grommet center top and modesty. Upgrade grommet cover to silver at no charge.

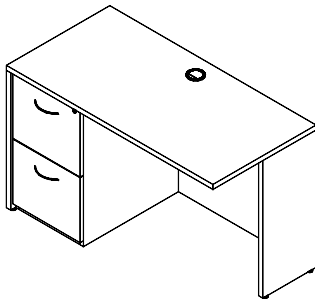

Freestanding Return Full Modesty Left File/File, Right Half Leg (H3B handles, lock)

Model#	Depth	Width	Height	Weight	Cube	Price
MCHARD2036L	20"	36"	29"	130	13	\$2,059
MCHARD2042L	20"	42"	29"	140	15	\$2,081
MCHARD2048L	20"	48"	29"	150	17	\$2,106
MCHARD2054L	20"	54"	29"	160	19	\$2,152
MCHARD2436L	24"	36"	29"	140	15	\$2,213
MCHARD2442L	24"	42"	29"	150	18	\$2,228
MCHARD2448L	24"	48"	29"	160	20	\$2,277
MCHARD2454L	24"	54"	29"	170	23	\$2,372
MCHARD2460L	24"	60"	29"	180	24	\$2,389
MCHARD3048L	30"	48"	29"	175	25	\$2,389

Note: Full Modesty is standard. ½ or ¾ modesty may be specified add MMCUT1 \$150. Black grommet center top and modesty. Upgrade grommet cover to silver at no charge.

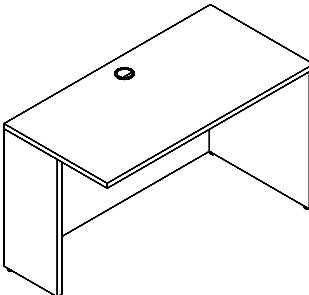

Freestanding Right Return Shell Full Modesty, Left Half Leg (H3B handles, lock)

Model#	Depth	Width	Height	Weight	Cube	Price
MCHARN2036R	20"	36"	29"	60	13	\$882
MCHARN2042R	20"	42"	29"	67	15	\$903
MCHARN2048R	20"	48"	29"	73	17	\$980
MCHARN2054R	20"	54"	29"	80	19	\$1,052
MCHARN2436R	24"	36"	29"	63	15	\$1,065
MCHARN2442R	24"	42"	29"	67	18	\$1,109
MCHARN2448R	24"	48"	29"	74	20	\$1,158
MCHARN2454R	24"	54"	29"	80	23	\$1,211
MCHARN3048R	30"	48"	29"	89	25	\$1,278

Note: Full Modesty is standard. ½ or ¾ modesty may be specified add MMCUT1 \$150. Black grommet center top and modesty. Upgrade grommet cover to silver at no charge.

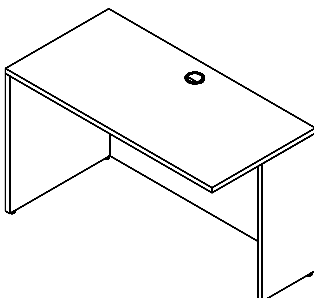

Freestanding Left Return Shell Full Modesty, Right Half Leg (H3B handles, lock)

Model#	Depth	Width	Height	Weight	Cube	Price
MCHARN2036L	20"	36"	29"	60	13	\$882
MCHARN2042L	20"	42"	29"	67	15	\$903
MCHARN2048L	20"	48"	29"	73	17	\$980
MCHARN2054L	20"	54"	29"	80	19	\$1,052
MCHARN2436L	24"	36"	29"	63	15	\$1,065
MCHARN2442L	24"	42"	29"	67	18	\$1,109
MCHARN2448L	24"	48"	29"	74	20	\$1,158
MCHARN2454L	24"	54"	29"	80	23	\$1,211
MCHARN3048L	30"	48"	29"	89	25	\$1,278

Note: Full Modesty is standard. ½ or ¾ modesty may be specified add MMCUT1 \$150. Black grommet center top and modesty. Upgrade grommet cover to silver at no charge.

# maverick series

## Freestanding Returns

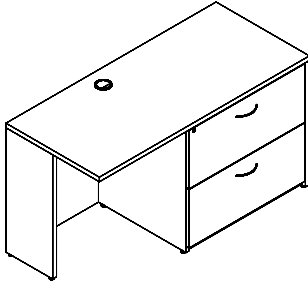

Freestanding Return Full Modesty Right 31" Lateral File, Left Half Leg (H3B handles, lock)

Model#	Depth	Width	Height	Weight	Cube	Price
MCHARLF2054R	20"	54"	29"	192	19	\$2,390
MCHARLF2060R	20"	60"	29"	198	21	\$2,407
MCHARLF2454R	24"	54"	29"	201	23	\$2,390
MCHARLF2460R	24"	60"	29"	208	25	\$2,557

**Note: Full Modesty is standard. 1/2 or 3/4 modesty may be specified add MMCUT1 \$150. Black grommet center top and modesty. Upgrade grommet cover to silver at no charge.**

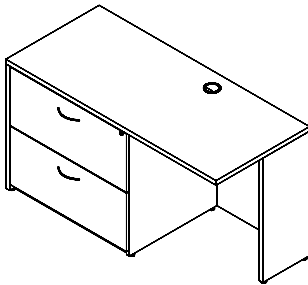

Freestanding Return Full Modesty Left 31" Lateral File, Right Half Leg (H3B handles, lock)

Model#	Depth	Width	Height	Weight	Cube	Price
MCHARLF2054L	20"	54"	29"	192	19	\$2,390
MCHARLF2060L	20"	60"	29"	198	21	\$2,407
MCHARLF2454L	24"	54"	29"	201	23	\$2,390
MCHARLF2460L	24"	60"	29"	208	25	\$2,557

**Note: Full Modesty is standard. 1/2 or 3/4 modesty may be specified add MMCUT1 \$150. Black grommet center top and modesty. Upgrade grommet cover to silver at no charge.**

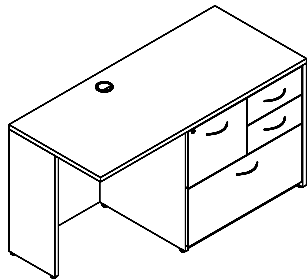

Freestanding Return Full Modesty Right 31" Personal Lateral File, Left Half Leg (H3B handles, lock)

Model#	Depth	Width	Height	Weight	Cube	Price
MCHARPLF2054R	20"	54"	29"	195	19	\$2,573
MCHARPLF2060R	20"	60"	29"	201	23	\$2,653
MCHARPLF2454R	24"	54"	29"	205	23	\$2,600
MCHARPLF2460R	24"	60"	29"	213	28	\$2,703

**Note: Full Modesty is standard. 1/2 or 3/4 modesty may be specified add MMCUT1 \$150. Black grommet center top and modesty. Upgrade grommet cover to silver at no charge.**

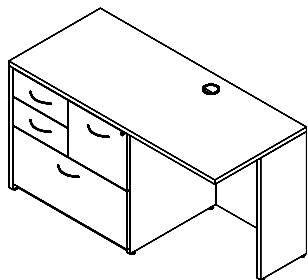

Freestanding Return Full Modesty Left 31" Personal Lateral File, Right Half Leg (H3B handles, lock)

Model#	Depth	Width	Height	Weight	Cube	Price
MCHARPLF2054L	20"	54"	29"	195	19	\$2,573
MCHARPLF2060L	20"	60"	29"	201	23	\$2,653
MCHARPLF2454L	24"	54"	29"	205	23	\$2,600
MCHARPLF2460L	24"	60"	29"	213	28	\$2,703

**Note: Full Modesty is standard. 1/2 or 3/4 modesty may be specified add MMCUT1 \$150. Black grommet center top and modesty. Upgrade grommet cover to silver at no charge.**

# maverick series

## Credenzas

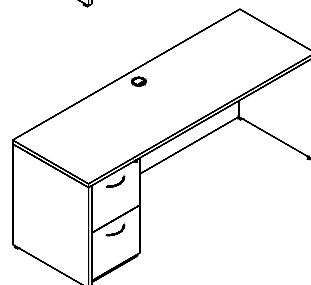
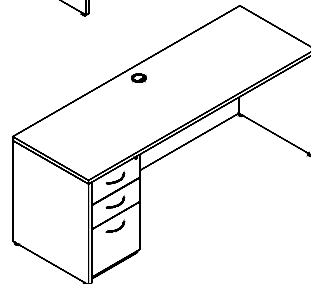
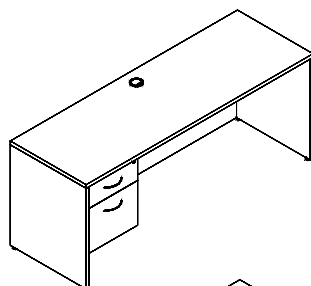
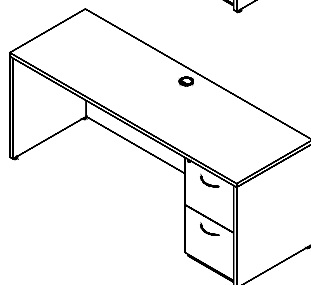
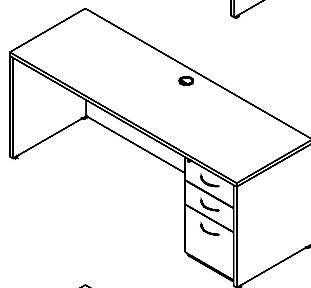
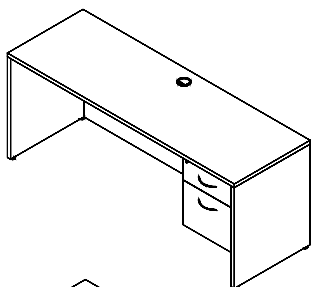

### Credenza, Single Box/File Pedestal Right (Full modesty, H3B handles, lock)

Model#	Depth	Width	Height	Weight	Cube	Price
MCC2060 4R	20"	60"	29"	150	21	\$1,609
MCC2066 4R	20"	66"	29"	157	23	\$1,764
MCC2072 4R	20"	72"	29"	164	25	\$1,792
MCC2472 4R	24"	72"	29"	168	30	\$1,836

Black grommet center top and modesty. Upgrade grommet cover to silver at no charge.

### Credenza, Single Box/Box/File Pedestal Right (Full modesty, H3B handles, lock)

Model#	Depth	Width	Height	Weight	Cube	Price
MCCC2060 4R	20"	60"	29"	185	21	\$2,218
MCCC2066 4R	20"	66"	29"	190	23	\$2,393
MCCC2072 4R	20"	72"	29"	200	25	\$2,416
MCCC2472 4R	24"	72"	29"	220	30	\$2,465

Black grommet center top and modesty. Upgrade grommet cover to silver at no charge.

### Credenza, Single File/File Pedestal Right (Full modesty, H3B handles, lock)

Model#	Depth	Width	Height	Weight	Cube	Price
MCCD2060 4R	20"	60"	29"	183	21	\$2,121
MCCD2066 4R	20"	66"	29"	190	23	\$2,302
MCCD2072 4R	20"	72"	29"	200	25	\$2,324
MCCD2472 4R	24"	72"	29"	220	30	\$2,371

Black grommet center top and modesty. Upgrade grommet cover to silver at no charge.

### Credenza, Single Box/File Pedestal Left (Full modesty, H3B handles, lock)

Model#	Depth	Width	Height	Weight	Cube	Price
MCC2060 4L	20"	60"	29"	150	21	\$1,609
MCC2066 4L	20"	66"	29"	157	23	\$1,764
MCC2072 4L	20"	72"	29"	164	25	\$1,792
MCC2472 4L	24"	72"	29"	168	30	\$1,836

Black grommet center top and modesty. Upgrade grommet cover to silver at no charge.

### Credenza, Single Box/Box/File Pedestal Left (Full modesty, H3B handles, lock)

Model#	Depth	Width	Height	Weight	Cube	Price
MCCC2060 4L	20"	60"	29"	185	21	\$2,218
MCCC2066 4L	20"	66"	29"	190	23	\$2,393
MCCC2072 4L	20"	72"	29"	200	25	\$2,416
MCCC2472 4L	24"	72"	29"	220	30	\$2,465

Black grommet center top and modesty. Upgrade grommet cover to silver at no charge.

### Credenza, Single File/File Pedestal Left (Full modesty, H3B handles, lock)

Model#	Depth	Width	Height	Weight	Cube	Price
MCCD2060 4L	20"	60"	29"	183	21	\$2,121
MCCD2066 4L	20"	66"	29"	190	23	\$2,302
MCCD2072 4L	20"	72"	29"	200	25	\$2,324
MCCD2472 4L	24"	72"	29"	220	30	\$2,371

Black grommet center top and modesty. Upgrade grommet cover to silver at no charge.

For available accessories and upgrades, see pages 56–59.

# maverick series

## Credenzas

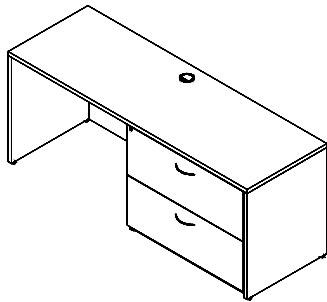

Credenza, Right 36" Lateral File Pedestal (H3B handles, lock, full modesty)

Model#	Depth	Width	Height	Weight	Cube	Price
MCC2066 5R	20"	66"	29"	223	23	\$2,472
MCC2072 5R	20"	72"	29"	230	25	\$2,495
MCC2472 5R	24"	72"	29"	270	30	\$2,607

**Black grommet center top and modesty. Upgrade grommet cover to silver at no charge.**

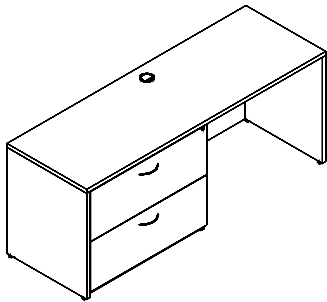

Credenza, Left 36" Lateral File Pedestal (H3B handles, lock, full modesty)

Model#	Depth	Width	Height	Weight	Cube	Price
MCC2066 5L	20"	66"	29"	223	23	\$2,472
MCC2072 5L	20"	72"	29"	230	25	\$2,495
MCC2472 5L	24"	72"	29"	270	30	\$2,607

**Black grommet center top and modesty. Upgrade grommet cover to silver at no charge.**

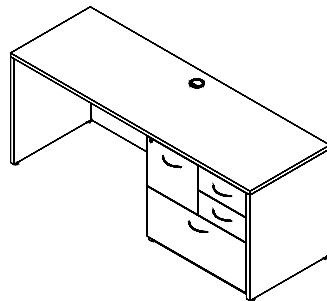

Credenza, Right 31" Personal Lateral File Pedestal (H3B handles, lock, full modesty)

Model#	Depth	Width	Height	Weight	Cube	Price
MCC2066 6R	20"	66"	29"	230	26	\$2,831
MCC2072 6R	20"	72"	29"	236	28	\$2,865
MCC2472 6R	24"	72"	29"	260	30	\$2,976

**Box drawers do not lock. 1 Lock — locks file & lateral file drawer. Black grommet center top and modesty. Upgrade grommet cover to silver at no charge.**

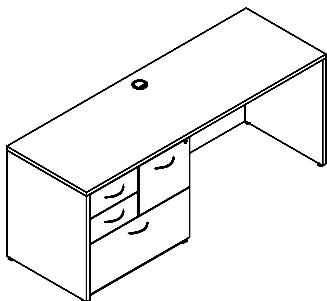

Credenza, Left 31" Personal Lateral File Pedestal (H3B handles, lock, full modesty)

Model#	Depth	Width	Height	Weight	Cube	Price
MCC2066 6L	20"	66"	29"	230	26	\$2,831
MCC2072 6L	20"	72"	29"	236	28	\$2,865
MCC2472 6L	24"	72"	29"	260	30	\$2,976

**Box drawers do not lock. 1 Lock — locks file & lateral file drawer. Black grommet center top and modesty. Upgrade grommet cover to silver at no charge.**

For available accessories and upgrades, see pages 56–59.

# maverick series

## CompuCorner Credenzas

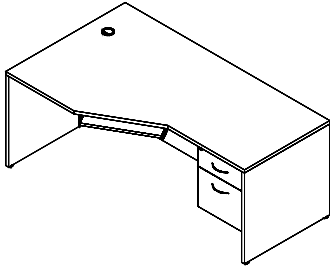

Computer Corner, Box/File Pedestal Right (H3B handles, lock, full modesty)

Model#	(L)	(B)	(E)	(K)	(R)	(W)	Weight	Cube	Price
MCCD60 2R	60"	30"	20"	21"	20"	21"	220	32	\$1,744
MCCD60 4R	60"	36"	24"	21"	24"	22"	220	32	\$1,764
MCCD66 4R	66"	36"	24"	21"	24"	24"	229	42	\$1,889
MCCD72 3R	72"	36"	20"	24"	20"	33"	249	45	\$1,996
MCCD72 4R	72"	36"	24"	21"	24"	30"	249	45	\$1,814
MCCD72 7R	72"	36"	24"	23"	20"	32"	285	45	\$1,970
MCCD72 8R	72"	42"	24"	24"	24"	33"	285	53	\$2,366

Keyboard tray & worksurface black grommet standard. Upgrade grommet cover to silver at no charge.

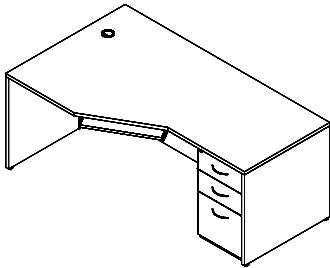

Computer Corner, Box/Box/File Pedestal Right (H3B handles, lock, full modesty)

Model#	(L)	(B)	(E)	(K)	(R)	(W)	Weight	Cube	Price
MCCD60C 2R	60"	30"	20"	21"	20"	21"	235	32	\$2,371
MCCD60C 4R	60"	36"	24"	21"	24"	22"	235	32	\$2,398
MCCD66C 4R	66"	36"	24"	21"	24"	24"	245	42	\$2,521
MCCD72C 3R	72"	36"	20"	24"	20"	33"	265	45	\$2,622
MCCD72C 4R	72"	36"	24"	21"	24"	30"	265	45	\$2,439
MCCD72C 7R	72"	36"	24"	23"	20"	32"	300	45	\$2,599
MCCD72C 8R	72"	42"	24"	24"	24"	33"	300	53	\$2,997

Keyboard tray & worksurface black grommet standard. Upgrade grommet cover to silver at no charge.

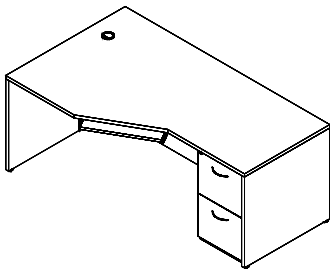

Computer Corner, File/File Pedestal Right (H3B handles, lock, full modesty)

Model#	(L)	(B)	(E)	(K)	(R)	(W)	Weight	Cube	Price
MCCD60D 2R	60"	30"	20"	21"	20"	21"	235	32	\$2,276
MCCD60D 4R	60"	36"	24"	21"	24"	22"	235	32	\$2,304
MCCD66D 4R	66"	36"	24"	21"	24"	24"	245	42	\$2,343
MCCD72D 3R	72"	36"	20"	24"	20"	33"	265	45	\$2,448
MCCD72D 4R	72"	36"	24"	21"	24"	30"	265	45	\$2,347
MCCD72D 7R	72"	36"	24"	23"	20"	32"	300	45	\$2,502
MCCD72D 8R	72"	42"	24"	24"	24"	33"	300	53	\$2,902

Keyboard tray & worksurface black grommet standard. Upgrade grommet cover to silver at no charge.

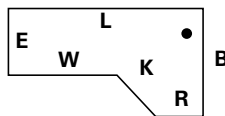

"L" Length along approach edge

"B" Back end panel

"E" End panel

"K" Keyboard space

"R" Return size to attach

"W" Workarea (kbrd to end)

For available accessories and upgrades, see pages 56–59.

# maverick series

## CompuCorner Credenzas

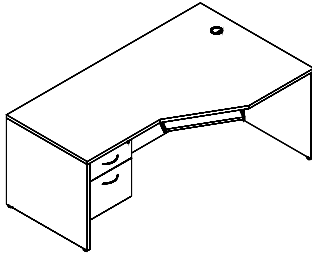

Computer Corner, Box/File Pedestal Left (H3B handles, lock, full modesty)

Model#	(L)	(B)	(E)	(K)	(R)	(W)	Weight	Cube	Price
☞ MCCD60 2L	60"	30"	20"	21"	20"	21"	220	32	\$1,744
☞ MCCD60 4L	60"	36"	24"	21"	24"	22"	220	32	\$1,764
☞ MCCD66 4L	66"	36"	24"	21"	24"	24"	229	42	\$1,889
☞ MCCD72 3L	72"	36"	20"	24"	20"	33"	249	45	\$1,996
☞ MCCD72 4L	72"	36"	24"	21"	24"	30"	249	45	\$1,814
☞ MCCD72 7L	72"	36"	24"	23"	20"	32"	285	45	\$1,970
☞ MCCD72 8L	72"	42"	24"	24"	24"	33"	285	53	\$2,366

Keyboard tray & worksurface black grommet standard. Upgrade grommet cover to silver at no charge.

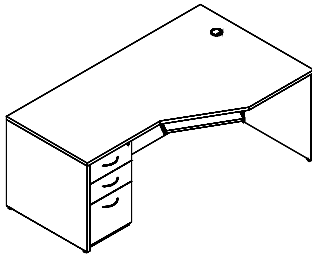

Computer Corner, Box/Box/File Pedestal Left (H3B handles, lock, full modesty)

Model#	(L)	(B)	(E)	(K)	(R)	(W)	Weight	Cube	Price
☞ MCCD60C 2L	60"	30"	20"	21"	20"	21"	235	32	\$2,371
☞ MCCD60C 4L	60"	36"	24"	21"	24"	22"	235	32	\$2,398
☞ MCCD66C 4L	66"	36"	24"	21"	24"	24"	245	42	\$2,521
☞ MCCD72C 3L	72"	36"	20"	24"	20"	33"	265	45	\$2,622
☞ MCCD72C 4L	72"	36"	24"	21"	24"	30"	265	45	\$2,439
☞ MCCD72C 7L	72"	36"	24"	23"	20"	32"	300	45	\$2,599
☞ MCCD72C 8L	72"	42"	24"	24"	24"	33"	300	53	\$2,997

Keyboard tray & worksurface black grommet standard. Upgrade grommet cover to silver at no charge.

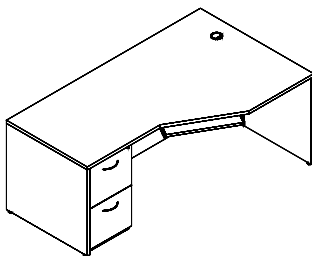

Computer Corner, File/File Pedestal Left (H3B handles, lock, full modesty)

Model#	(L)	(B)	(E)	(K)	(R)	(W)	Weight	Cube	Price
☞ MCCD60D 2L	60"	30"	20"	21"	20"	21"	235	32	\$2,276
☞ MCCD60D 4L	60"	36"	24"	21"	24"	22"	235	32	\$2,304
☞ MCCD66D 4L	66"	36"	24"	21"	24"	24"	245	42	\$2,343
☞ MCCD72D 3L	72"	36"	20"	24"	20"	33"	265	45	\$2,448
☞ MCCD72D 4L	72"	36"	24"	21"	24"	30"	265	45	\$2,347
☞ MCCD72D 7L	72"	36"	24"	23"	20"	32"	300	45	\$2,502
☞ MCCD72D 8L	72"	42"	24"	24"	24"	33"	300	53	\$2,902

Keyboard tray & worksurface black grommet standard. Upgrade grommet cover to silver at no charge.

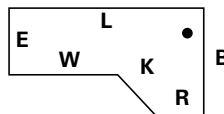

- "L" Length along approach edge
- "B" Back end panel
- "E" End panel
- "K" Keyboard space
- "R" Return size to attach
- "W" Workarea (kbrd to end)

For available accessories and upgrades, see pages 56–59.

# maverick series

## CompuCorner Credenzas

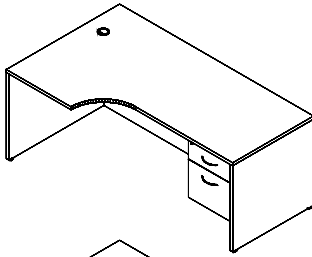

Computer Corner, Curved, ¾ Box/File Pedestal Right (H3B handles, lock, full modesty)

Model#	(L)	(B)	(E)	(K)	(R)	(W)	Weight	Cube	Price
☞ MCCDQ72 4R	72"	36"	24"	21"	24"	30"	239	45	\$1,814

No keyboard tray. Worksurface black grommet standard. Upgrade grommet cover to silver at no charge.

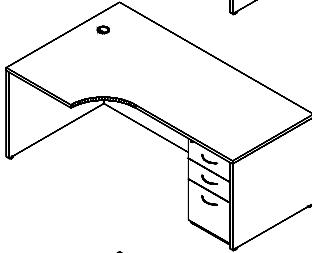

Computer Corner, Curved, Box/Box/File Pedestal Right (H3B handles, lock, full modesty)

Model#	(L)	(B)	(E)	(K)	(R)	(W)	Weight	Cube	Price
☞ MCCDQ72C 4R	72"	36"	24"	21"	24"	30"	254	45	\$2,439

No keyboard tray. Worksurface black grommet standard. Upgrade grommet cover to silver at no charge.

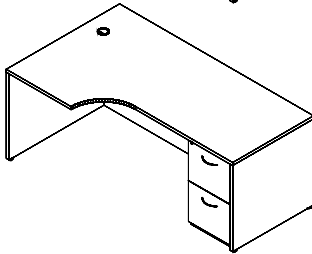

Computer Corner, Curved, File/File Pedestal Right (H3B handles, lock, full modesty)

Model#	(L)	(B)	(E)	(K)	(R)	(W)	Weight	Cube	Price
☞ MCCDQ72D 4R	72"	36"	24"	21"	24"	30"	254	45	\$2,347

No keyboard tray. Worksurface black grommet standard. Upgrade grommet cover to silver at no charge.

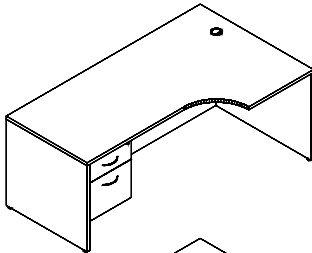

Computer Corner, Curved, ¾ Box/File Pedestal Left (H3B handles, lock, full modesty)

Model#	(L)	(B)	(E)	(K)	(R)	(W)	Weight	Cube	Price
☞ MCCDQ72 4L	72"	36"	24"	21"	24"	30"	239	45	\$1,814

No keyboard tray. Worksurface black grommet standard. Upgrade grommet cover to silver at no charge.

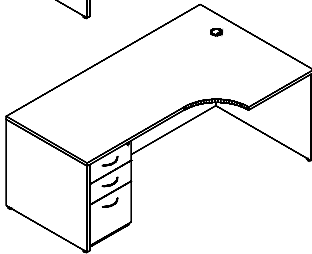

Computer Corner, Curved, Box/Box/File Pedestal Left (H3B handles, lock, full modesty)

Model#	(L)	(B)	(E)	(K)	(R)	(W)	Weight	Cube	Price
☞ MCCDQ72C 4L	72"	36"	24"	21"	24"	30"	254	45	\$2,439

No keyboard tray. Worksurface black grommet standard. Upgrade grommet cover to silver at no charge.

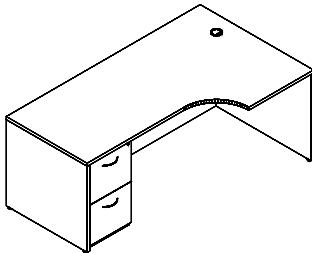

Computer Corner, Curved, File/File Pedestal Left (H3B handles, lock, full modesty)

Model#	(L)	(B)	(E)	(K)	(R)	(W)	Weight	Cube	Price
☞ MCCDQ72D 4L	72"	36"	24"	21"	24"	30"	254	45	\$2,347

No keyboard tray. Worksurface black grommet standard. Upgrade grommet cover to silver at no charge.

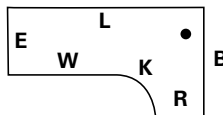

- "L" Length along approach edge
- "B" Back end panel
- "E" End panel
- "K" Keyboard space
- "R" Return size to attach
- "W" Workarea (kbrd to end)

For available accessories and upgrades, see pages 56–59.



# maverick series

## CompuCorner Credenzas

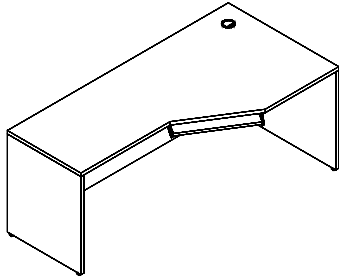

### Computer Corner Shell (Full modesty), For Right Return

Model#	(L)	(B)	(E)	(K)	(R)	(W)	Weight	Cube	Price
☞ MCCDN60 2R	60"	30"	20"	21"	20"	21"	184	32	\$1,286
☞ MCCDN72 3R	72"	36"	20"	24"	20"	33"	213	45	\$1,491
☞ MCCDN72 4R	72"	36"	24"	21"	24"	30"	213	45	\$1,542

Keyboard tray & worksurface black grommet standard. Upgrade grommet cover to silver at no charge.

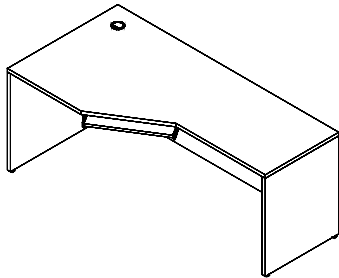

### Computer Corner Shell (Full modesty), For Left Return

Model#	(L)	(B)	(E)	(K)	(R)	(W)	Weight	Cube	Price
☞ MCCDN60 2L	60"	30"	20"	21"	20"	21"	184	32	\$1,286
☞ MCCDN72 3L	72"	36"	20"	24"	20"	33"	213	45	\$1,491
☞ MCCDN72 4L	72"	36"	24"	21"	24"	30"	213	45	\$1,542

Keyboard tray & worksurface black grommet standard. Upgrade grommet cover to silver at no charge.

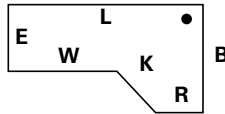

- "L" Length along approach edge
- "B" Back end panel
- "E" End panel
- "K" Keyboard space
- "R" Return size to attach
- "W" Workarea (kbrd to end)

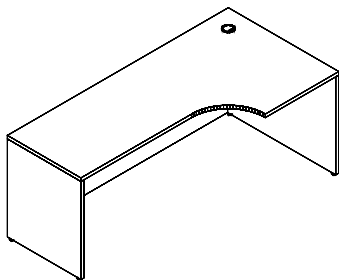

### Computer Corner Shell, Curved (Full modesty), For Right Return

Model#	(L)	(B)	(E)	(K)	(R)	(W)	Weight	Cube	Price
☞ MCCDNQ72 4R	72"	36"	24"	21"	24"	30"	213	45	\$1,542

No keyboard tray. Worksurface black grommet standard. Upgrade grommet cover to silver at no charge.

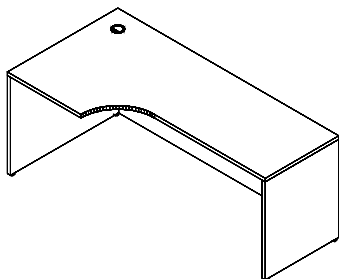

### Computer Corner Shell, Curved (Full modesty), For Left Return

Model#	(L)	(B)	(E)	(K)	(R)	(W)	Weight	Cube	Price
☞ MCCDNQ72 4L	72"	36"	24"	21"	24"	30"	213	45	\$1,542

No keyboard tray. Worksurface black grommet standard. Upgrade grommet cover to silver at no charge.

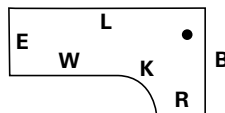

- "L" Length along approach edge
- "B" Back end panel
- "E" End panel
- "K" Keyboard space
- "R" Return size to attach
- "W" Workarea (kbrd to end)

For available accessories and upgrades, see pages 56–59.

# maverick series

## CompuCorner Credenzas

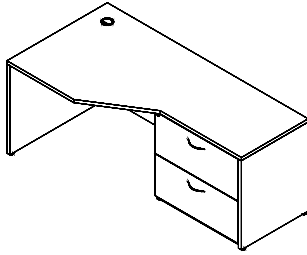

Computer Corner, Right 31" Lateral File (H3B handles, lock, full modesty)

Model#	(L)	(B)	(E)	(K)	(R)	(W)	Weight	Cube	Price
MCCD72LF 3R	72"	36"	20"	24"	20"	33"	249	45	\$2,436
MCCD72LF 4R	72"	36"	24"	21"	24"	30"	265	45	\$2,571

No keyboard tray. Worksurface black grommet standard. Upgrade grommet cover to silver at no charge.

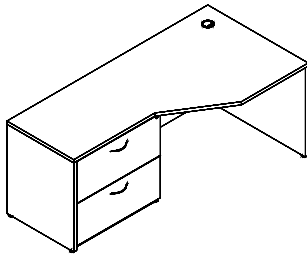

Computer Corner, Left 31" Lateral File (H3B handles, lock, full modesty)

Model#	(L)	(B)	(E)	(K)	(R)	(W)	Weight	Cube	Price
MCCD72LF 3L	72"	36"	20"	24"	20"	33"	249	45	\$2,436
MCCD72LF 4L	72"	36"	24"	21"	24"	30"	265	45	\$2,571

No keyboard tray. Worksurface black grommet standard. Upgrade grommet cover to silver at no charge.

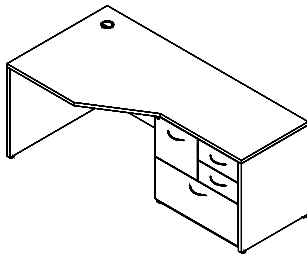

Computer Corner, Right 31" Personal Lateral File (H3B handles, lock, full modesty)

Model#	(L)	(B)	(E)	(K)	(R)	(W)	Weight	Cube	Price
MCCD72PLF 3R	72"	36"	20"	24"	20"	33"	249	45	\$2,742
MCCD72PLF 4R	72"	36"	24"	21"	24"	30"	265	45	\$2,809

No keyboard tray & worksurface black grommet standard. Upgrade grommet cover to silver at no charge. Box drawers do not lock. 1 Lock — locks file & lateral file drawer.

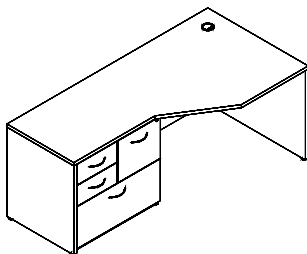

Computer Corner, Left 31" Personal Lateral File (H3B handles, lock, full modesty)

Model#	(L)	(B)	(E)	(K)	(R)	(W)	Weight	Cube	Price
MCCD72PLF 3L	72"	36"	20"	24"	20"	33"	249	45	\$2,742
MCCD72PLF 4L	72"	36"	24"	21"	24"	30"	265	45	\$2,809

No keyboard tray & worksurface black grommet standard. Upgrade grommet cover to silver at no charge. Box drawers do not lock. 1 Lock — locks file & lateral file drawer.

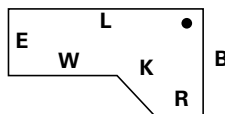

- "L" Length along approach edge
- "B" Back end panel
- "E" End panel
- "K" Keyboard space
- "R" Return size to attach
- "W" Workarea (kbrd to end)

For available accessories and upgrades, see pages 56–59.

# maverick series

## Credenzas

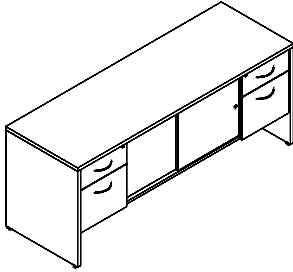

**Credenza, Double Pedestal, Box/File Left and Right, Center Storage**  
(Sliding doors, full modesty, H3B handles, 2 locks)

Model#	Depth	Width	Height	Weight	Cube	Price
☞ MCC2060 2	20"	60"	29"	230	21	\$1,970
☞ MCC2066 2	20"	66"	29"	240	23	\$2,278
☞ MCC2072 2	20"	72"	29"	250	25	\$2,297
☞ MCC2472 2	24"	72"	29"	270	30	\$2,425

Storage includes one adjustable ¾" thick shelf. Sliding doors do not lock.

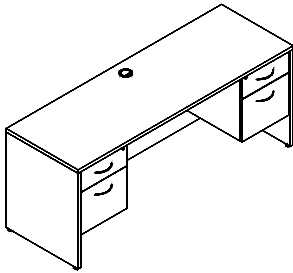

**Credenza, Double Pedestal, Box/File Left and Right**  
(Knee space, full modesty, H3B handles, 2 locks)

Model#	Depth	Width	Height	Weight	Cube	Price
☞ MCC2060 3	20"	60"	29"	196	21	\$1,996
☞ MCC2066 3	20"	66"	29"	205	23	\$2,312
☞ MCC2072 3	20"	72"	29"	210	25	\$2,348
☞ MCC2472 3	24"	72"	29"	230	30	\$2,400

Black grommet center top and modesty. Upgrade grommet cover to silver at no charge.

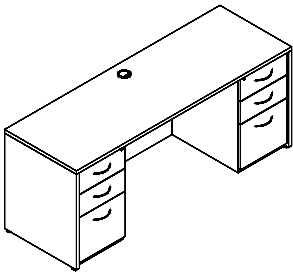

**Credenza, Double Pedestal, Box/Box/File Left and Right**  
(Knee space, full modesty, H3B handles, 2 locks)

Model#	Depth	Width	Height	Weight	Cube	Price
☞ MCCC2060 3	20"	60"	29"	245	21	\$2,805
☞ MCCC2066 3	20"	66"	29"	255	23	\$3,123
☞ MCCC2072 3	20"	72"	29"	265	25	\$3,155
☞ MCCC2472 3	24"	72"	29"	290	30	\$3,210

Black grommet center top and modesty. Upgrade grommet cover to silver at no charge.  
For left Box/Box/File and right File/File configuration, use MCCC\_ \_ \_ \_ at no charge.

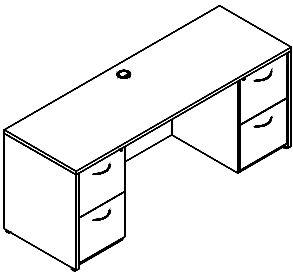

**Credenza, Double Pedestal, File/File Left and Right**  
(Knee space, full modesty, H3B handles, 2 locks)

Model#	Depth	Width	Height	Weight	Cube	Price
☞ MCCD2060 3	20"	60"	29"	245	21	\$2,676
☞ MCCD2066 3	20"	66"	29"	255	23	\$2,999
☞ MCCD2072 3	20"	72"	29"	265	25	\$3,033
☞ MCCD2472 3	24"	72"	29"	290	30	\$3,085

Black grommet center top and modesty. Upgrade grommet cover to silver at no charge.

For available accessories and upgrades, see pages 56–59.

# maverick series

## Credenzas

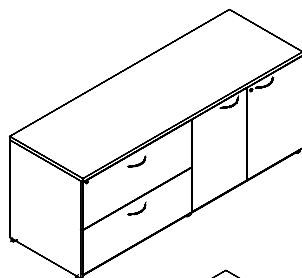

Credenza, Hinged Door Cabinet Right and Lateral File Left (H3B handles, 2 locks)

Model#	Depth	Width	Height	Weight	Cube	Price
MCC2072 9FPL	20"	72"	29"	270	30	\$3,020
MCC2472 9FPL	24"	72"	29"	290	30	\$3,097

Cabinet includes 1 adjustable shelf ¾" thick.

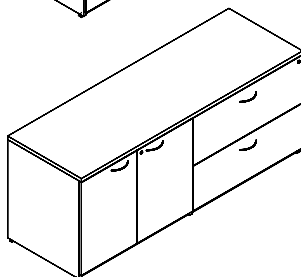

Credenza, Hinged Door Cabinet Left and Lateral File Right (H3B handles, 2 locks)

Model#	Depth	Width	Height	Weight	Cube	Price
MCC2072 9FPR	20"	72"	29"	270	30	\$3,020
MCC2472 9FPR	24"	72"	29"	290	30	\$3,097

Cabinet includes 1 adjustable shelf ¾" thick.

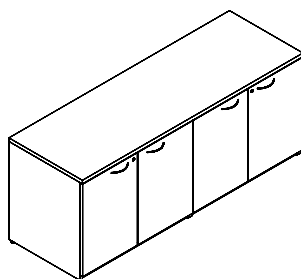

Credenza, Full Storage (4 Full hinged doors, 2 adjustable shelves, H3B handles, 2 locks)

Model#	Depth	Width	Height	Weight	Cube	Price
MCC2048 1FP	20"	48"	29"	155	17	\$2,545
MCC2448 1FP	24"	48"	29"	175	20	\$2,658
MCC2060 1FP	20"	60"	29"	220	21	\$2,716
MCC2066 1FP	20"	66"	29"	240	23	\$2,919
MCC2072 1FP	20"	72"	29"	260	25	\$2,953
MCC2472 1FP	24"	72"	29"	295	30	\$3,181
MCC207236 1FP	20"	72"	36"	238	30	\$3,158
MCC247236 1FP	24"	72"	36"	265	36	\$3,310

Storage includes 1 adjustable shelf ¾" thick per side.

Note: H11 & H14 handles are installed vertically on 48" & 60"W credenzas.

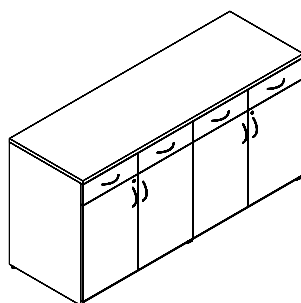

Buffet Credenza, 4 box drawers, 4 full hinged doors (H3B handles, 2 locks doors only)

Model#	Depth	Width	Height	Weight	Cube	Price
*MCHDBC2036	20"	36"	36"	220	15	\$2,138
*MCHDBC2436	24"	36"	36"	240	18	\$2,311
MCHDBC2060	20"	60"	36"	236	25	\$3,954
MCHDBC2460	24"	60"	36"	261	30	\$4,099
MCHDBC2072	20"	72"	36"	260	30	\$3,996
MCHDBC2472	24"	72"	36"	290	36	\$4,152

Storage includes 1 adjustable shelf ¾" thick per side.

\*36"W credenza: 2 box drawers, 2 hinged doors, 1 adjustable shelf, 1 lock.

Optional face locks available for box drawers, add MMFL \$118 each.

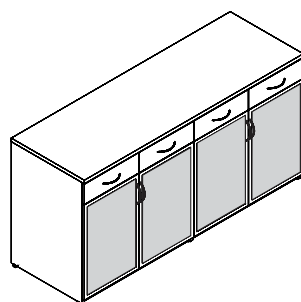

Buffet Credenza, 4 box drawers, 4 hinged frosted glass doors (H3B handles)

Model#	Depth	Width	Height	Weight	Cube	Price
*MCHDBC2036G	20"	36"	36"	220	15	\$2,352
*MCHDBC2436G	24"	36"	36"	240	18	\$2,515
MCHDBC2072G	20"	72"	36"	240	18	\$5,062
MCHDBC2472G	24"	72"	36"	290	36	\$5,215

Storage includes 1 adjustable shelf ¾" thick per side.

\*36"W credenza: 2 box drawers & 2 glass doors, 1 adjustable shelf.

Optional face locks available for box drawers, add MMFL \$118 each. Locks N/A for glass doors.

Glass doors are frosted with vinyl-wrapped MDF frame.

For available accessories and upgrades, see pages 56–59.

# maverick series

## Planters

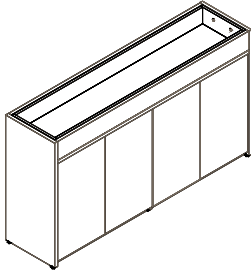

### Planter Storage Credenza 4 Touch Latch Hinged Doors (4 Adjustable shelves & ¾" planter box)

Model#	Depth	Width	Height	Weight	Cube	Price
MCCP186040 1FP	18"	60"	40"	260	25	\$4,400
MCCP187240 1FP	18"	72"	40"	300	30	\$4,584

60"W Planter Box: 15<sup>13</sup>/<sub>16</sub>"D x 57<sup>13</sup>/<sub>16</sub>"W x 6"H.

72"W Planter Box: 15<sup>13</sup>/<sub>16</sub>"D x 69"W x 6"H.

2 Adjustable shelves ¾" per side. Locks N/A. Overall height 40".

Planter Box ships for field install & are for artificial plants only. **2⊕ LEAD TIME**

## Hutches

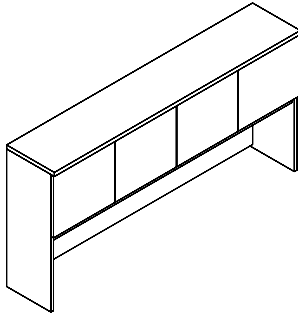

### Hutch Four Doors with Fascia (18" below fascia)

Model#	Depth	Width	Height	# Doors	Weight	Cube	Price
☞ MCH48WD	14"	48"	36"	4	130	14	\$1,749
☞ MCH60WD	14"	60"	36"	4	155	18	\$1,870
☞ MCH66WD	14"	66"	36"	4	167	20	\$2,020
☞ MCH72WD	14"	72"	36"	4	179	21	\$2,065
☞ Glass Doors MCH72WG	14"	72"	36"	4	179	21	\$2,854
MCH4842WD	14"	48"	42"	4	150	15	\$2,016
MCH6042WD	14"	60"	42"	4	175	19	\$2,137
MCH6642WD	14"	66"	42"	4	187	21	\$2,286
MCH7242WD	14"	72"	42"	4	199	22	\$2,332
☞ Glass Doors MCH7242WG	14"	72"	42"	4	199	22	\$3,120

Optional face locks (2 locks required), add MMFL \$118 each. Locks N/A for glass doors.

42"H hutches: Bottom clearance below fascia 23 ¼". Doors & fixed shelf does not change.

Glass doors are frosted with vinyl-wrapped MDF frame.

Ends are ¾" thick; doors overlay legs but are inset to the 1" thick top. Back panel ¾" gap.

For tasklights & tackboards, see page 55. 35lb. weight capacity distributed evenly.

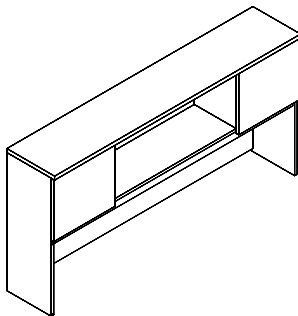

### Hutch, Left and Right Door, Center Opening with Fascia (18" below fascia)

Model#	Depth	Width	Height	# Doors	Weight	Cube	Price
MCH60W2D	14"	60"	36"	2	140	18	\$1,712
MCH66W2D	14"	66"	36"	2	152	20	\$1,794
MCH72W2D	14"	72"	36"	2	164	21	\$1,870
MCH6042W2D	14"	60"	42"	2	160	19	\$1,978
MCH6642W2D	14"	66"	42"	2	172	21	\$2,061
MCH7242W2D	14"	72"	42"	2	184	22	\$2,137

Doors are same width as open space. Optional face locks (2 locks required), add MMFL \$118 each.

42"H hutches: Bottom clearance below fascia 23 ¼". Doors & fixed shelf does not change.

Ends are ¾" thick; doors overlay legs but are inset to the 1" thick top. Back panel ¾" gap.

For tasklights & tackboards, see page 55. 35lb. weight capacity distributed evenly.

**NOTE:** If hutch is being placed on L-unit return, ½ leg center support is recommended, add MMSPT \$97.

# maverick series

## Hutches

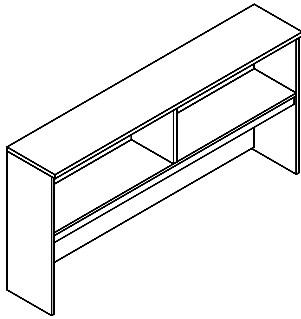

### Hutch No Doors with Fascia (18" Below fascia)

Model#	Depth	Width	Height	Weight	Cube	Price
☞ MCH48ND	14"	48"	36"	115	14	\$1,318
☞ MCH60ND	14"	60"	36"	135	18	\$1,361
☞ MCH66ND	14"	66"	36"	148	20	\$1,463
☞ MCH72ND	14"	72"	36"	160	21	\$1,600
MCH4842ND	14"	48"	42"	135	15	\$1,584
MCH6042ND	14"	60"	42"	155	19	\$1,629
MCH6642ND	14"	66"	42"	168	21	\$1,730
MCH7242ND	14"	72"	42"	180	22	\$1,866

**42"H hutches:** Bottom clearance below fascia 23 1/4". Fixed shelf does not change. Ends are 3/4" thick; doors overlay legs but are inset to the 1" thick top. Back panel 3/4" gap. For tasklights & tackboards, see page 55. 35lb. weight capacity distributed evenly.

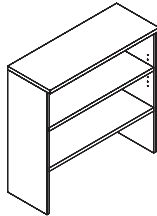

### Bookcase Hutch, Full Back Panel

(One adjustable shelf, one fixed shelf, 1" thick shelves) Bottom Clearance 12"H

Model#	Depth	Width	Height	Shelves	Weight	Cube	Price
MCBCH31	14"	31"	36"	2	72	11	\$651
☞ MCBCH36	14"	36"	36"	2	72	11	\$682
MCBCH3142	14"	31"	42"	2	92	12	\$918
MCBCH3642	14"	36"	42"	2	92	12	\$950

**42"H bookcase hutches:** 12"H bottom clearance does not change. Ends are 3/4" thick; doors overlay legs but are inset to the 1" thick top. Width coordinates with lateral files & utility cabinets. 35lb. weight capacity distributed evenly.

## Wall Mount Cabinets

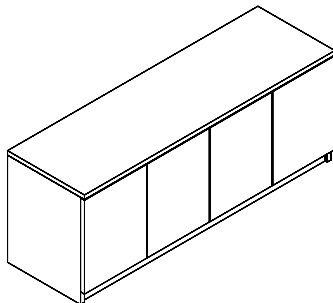
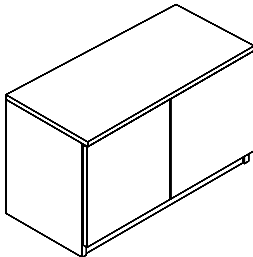

### Wall Mount Overhead Cabinet with Hinged Door Overlay, Finger Pull, Fascia (35lb. weight capacity)

Model#	Depth	Width	Height	# Doors	Weight	Cube	Price
MCCFOHD30	14 3/4"	30"	18 3/4"	2	110	7	\$1,195
MCCFOHD36	14 3/4"	36"	18 3/4"	2	110	7	\$1,228
MCCFOHD42	14 3/4"	42"	18 3/4"	2	120	9	\$1,411
MCCFOHD48	14 3/4"	48"	18 3/4"	4	120	9	\$1,455

\* Wall mount overhead storage includes fascia. Optional handles may be added, see page 57. Optional face lock (two required on 42"W and 48"W) MMFL add \$118/each. Requires professional installation and must be mounted to wall stud. 35lb. weight capacity distributed evenly.

**NOTE:** If hutch is being placed on L-unit return, 1/2 leg center support is recommended, add MMSPT \$97.

# maverick series

## Storage

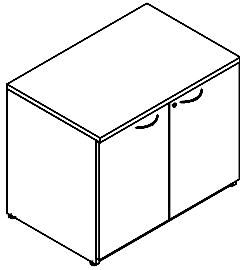

Hinged Door Utility Cabinet (H3B handles, one ¾" thick adjustable shelf, lock)

Model#	Depth	Width	Height	Weight	Cube	Price
MCHDC2036	20"	36"	29"	115	13	\$1,350
MCHDC2042	20"	42"	29"	165	15	\$1,421
MCHDC2436	24"	36"	29"	175	15	\$1,534
MCHDC2442	24"	42"	29"	180	18	\$1,649
MCHDC2436G	24"	36"	29"	175	18	\$1,898

Glass Doors

Width coordinates with bookcase hutch. Locks N/A for Glass doors.

Note: MCHDC2436G handles are installed vertically. Glass doors are frosted with vinyl-wrapped MDF frame.

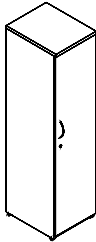

Single Storage Cabinet, Right Door (Three adjustable shelves, H3B handles, lock)

Model#	Depth	Width	Height	Weight	Cube	Price
MCSTS1665R	20"	16"	65"	185	12	\$1,627

Adjustable shelves are ¾" thick.

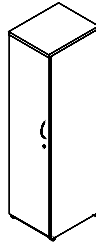

Single Storage Cabinet, Left Door (Three adjustable shelves, H3B handles, lock)

Model#	Depth	Width	Height	Weight	Cube	Price
MCSTS1665L	20"	16"	65"	185	12	\$1,627

Adjustable shelves are ¾" thick.

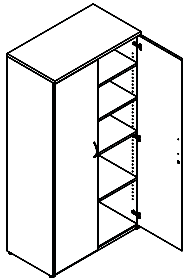

Double Storage Cabinet (Adjustable shelves, H3B handles, lock)

Model#	Depth	Width	Height	# Shelves	Weight	Cube	Price
MCST3642	20"	36"	42"	2	208	18	\$1,818
MCST3665	20"	36"	65"	3	290	27	\$2,442
MCST3672	20"	36"	71 ½"	4	370	30	\$2,734
MCST3684	20"	36"	84"	5	298	35	\$3,066
MCST243665	24"	36"	65"	3	290	27	\$2,704
MCST243672	24"	36"	71 ½"	4	370	30	\$2,967

Adjustable shelves are ¾" thick.

Cabinets 60"H & higher are made with required fixed shelf for locking.

Note: Cabinets 42"H are standard with horizontal handles.

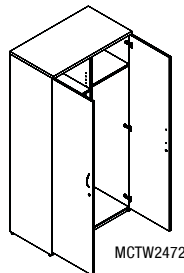
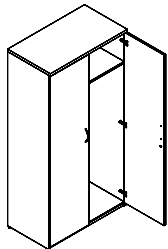

Wardrobe Cabinet (H3B handles, coat rack, one fixed shelf, lock)

Model#	Depth	Width	Height	Weight	Cube	Price
MCWC3665	24"	36"	65"	309	33	\$2,139
MCWC3672	24"	36"	71 ½"	325	36	\$2,465
MCTW2472	24"	36"	71 ½"	286	36	\$3,216

MCTW2472 includes: Left 4 adjustable shelves ¾" thick, right wardrobe, 2 locks.

For available accessories and upgrades, see pages 56–59.

# maverick series

## Storage

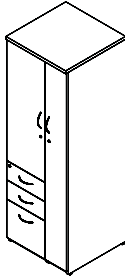

Personal Storage Cabinet - Left Door, 2 Adjustable Shelves & BBF, Right Long Door (H3B handles, 3 locks)

Model#	Depth	Width	Height	Weight	Cube	Price
MCWCP2465R	24"	24"	65"	309	22	\$3,492
MCWCP2472R	24"	24"	71 1/8"	325	24	\$3,739

Coat rack in long door compartment. Both doors & pedestal lock. 2 adjustable shelves 3/4" thick.

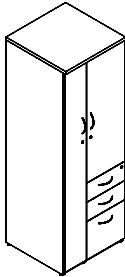

Personal Storage Cabinet - Right Door, 2 Adjustable Shelves & BBF, Left Long Door (H3B handles, 3 locks)

Model#	Depth	Width	Height	Weight	Cube	Price
MCWCP2465L	24"	24"	65"	309	22	\$3,492
MCWCP2472L	24"	24"	71 1/8"	325	24	\$3,739

Coat rack in long door compartment. Both doors & pedestal lock. 2 adjustable shelves 3/4" thick.

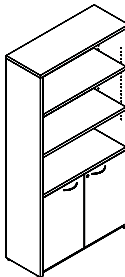

Bookcase with Storage Cabinet (H3B handles, lock, 1" thick adjustable shelves)

Model#	Depth	Width	Height	# Shelves	Weight	Cube	Price
MCBCD3660	14"	36"	60"	2	135	18	\$1,956
MCBCD3672	14"	36"	71 1/8"	3	145	21	\$2,021
MCBCD3684	14"	36"	84"	4	155	25	\$2,308

Adjustable shelf inside doors are 3/4" thick.

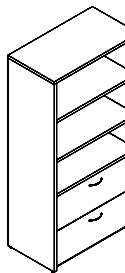

Bookcase with 36" Wide Lateral File (Adjustable shelves, H3B handles, lock)

Model#	Depth	Width	Height	# Shelves	Weight	Cube	Price
MCBCLF3660	20"	36 1/2"	60"	1	224	25	\$2,494
MCBCLF3672	20"	36 1/2"	71 1/8"	2	260	30	\$2,618
MCBCLF3684	20"	36 1/2"	84"	3	281	35	\$2,881

Adjustable shelves are 1" thick.

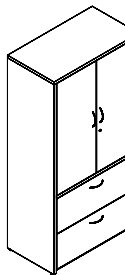

Bookcase with 36" Wide Lateral File & Doors (Adjustable shelves, H3B handles, 2 locks)

Model#	Depth	Width	Height	# Shelves	Weight	Cube	Price
MCBCLF3672WD	20"	36 1/2"	71 1/8"	2	300	30	\$3,323
MCBCLF3684WD	20"	36 1/2"	84"	3	331	35	\$3,684

Adjustable shelves are 1" thick.

For available accessories and upgrades, see pages 56–59. For color upgrade, see page 59.



# maverick series

## Storage

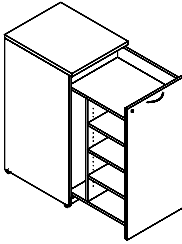

Slide Out Personal Storage Cabinet, Right Door Slide Out Storage (H3B handles, lock)

Model#	Depth	Width	Height	Weight	Cube	Price
MCSDS2442R	24"	20 1/2"	42"	200	12	\$3,317
MCSDS3042R	30"	20 1/2"	42"	234	15	\$3,542

Right-Side Slide Out Storage: 3 adjustable shelves 3/4" thick.  
Wardrobe compartment with coat/purse hook. 20 LEAD TIME

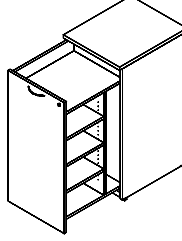

Slide Out Personal Storage Cabinet, Left Door Slide Out Storage (H3B handles, lock)

Model#	Depth	Width	Height	Weight	Cube	Price
MCSDS2442L	24"	20 1/2"	42"	200	12	\$3,317
MCSDS3042L	30"	20 1/2"	42"	234	15	\$3,542

Left-Side Slide Out Storage: 3 adjustable shelves 3/4" thick.  
Wardrobe compartment with coat/purse hook. 20 LEAD TIME

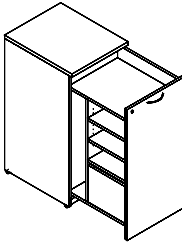

Slide Out Personal Storage Cabinet, Right Door Slide Out File Storage (H3B handles, lock)

Model#	Depth	Width	Height	Weight	Cube	Price
MCSDF2442R	24"	20 1/2"	42"	213	12	\$3,922
MCSDF3042R	30"	20 1/2"	42"	247	15	\$4,149

Right-Side Slide Out Storage: bottom file drawer, 2 adjustable shelves 3/4" thick.  
Wardrobe compartment with coat/purse hook. 20 LEAD TIME

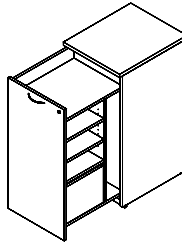

Slide Out Personal Storage Cabinet, Left Door Slide Out File Storage (H3B handles, lock)

Model#	Depth	Width	Height	Weight	Cube	Price
MCSDF2442L	24"	20 1/2"	42"	213	12	\$3,922
MCSDF3042L	30"	20 1/2"	42"	247	15	\$4,149

Left-Side Slide Out Storage: bottom file drawer, 2 adjustable shelves 3/4" thick.  
Wardrobe compartment with coat/purse hook. 20 LEAD TIME

**Note:** One color for top and one color for chassis may be specified.  
(chassis includes door)

## Bookcases

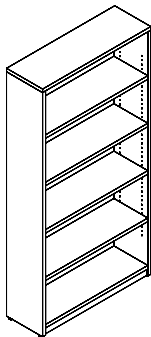

Bookcase (1" Thick adjustable shelves)

Model#	Depth	Width	Height	# Shelves	Weight	Cube	Price
MCBC3630	12"	36"	29"	1	61	18	\$701
MCBC3648	12"	36"	48"	2	86	12	\$944
MCBC3660	12"	36"	60"	3	107	15	\$1,137
MCBC3665	12"	36"	65"	3	111	17	\$1,185
MCBC3672	12"	36"	72"	4	128	18	\$1,230
MCBC3684	12"	36"	84"	5	137	21	\$1,537

For additional adjustable shelf, add MMSH1 \$171 ea. Includes 4 pins per shelf.  
Adjustable shelves recommended weight is 20 lbs each, distributed evenly.

## Printer Stand

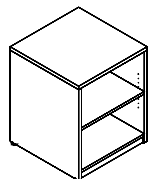

Printer Stand (Adjustable shelf, two back openings)

Model#	Depth	Width	Height	Weight	Cube	Price
MCPS2424	24"	24"	29"	65	10	\$877

For casters, add MMCAS \$150. Height does not increase.

For available accessories and upgrades, see pages 56–59. For color upgrade, see page 59.

# maverick series

## Files

(All drawers are 16"D except vertical files)

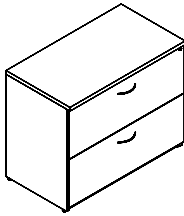

### 2 Drawer Lateral File (H3B handles, lock) Anti-Tip Interlock

Model#	Depth	Width	Height	Weight	Cube	Price
MCLF2031	20"	31"	29"	135	11	\$1,612
MCLF2431	24"	31"	29"	147	13	\$1,652
☞ MCLF202	20"	36"	29"	160	13	\$1,759
☞ MCLF242	24"	36"	29"	176	15	\$1,835

Includes anti-tip interlock.

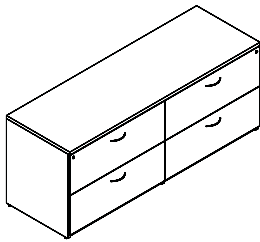

### 4 Drawer Double Lateral File (H3B handles, 2 locks)

Model#	Depth	Width	Height	Weight	Cube	Price
MCLF202+2	20"	72"	29"	330	25	\$3,033
MCLF242+2	24"	72"	29"	335	30	\$3,158

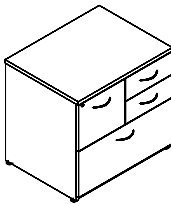

### Personal Lateral File 31" W (H3B handles, lock)

Model#	Depth	Width	Height	Weight	Cube	Price
MCPLF20	20"	31"	29"	189	11	\$1,700
MCPLF24	24"	31"	29"	205	13	\$1,775

Box drawers do not lock. 1 Lock — locks file & lateral file drawer.

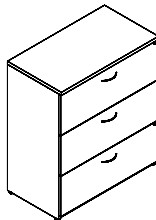

### 3 Drawer Lateral File (H3B handles, 2 locks) Anti-Tip Interlock

Model#	Depth	Width	Height	Weight	Cube	Price
20 MCLF203	20"	36"	42"	240	18	\$2,593
20 MCLF243	24"	36"	42"	264	22	\$2,694

REQUIRES 20 DAYS LEAD TIME. Lock positions are different from previous models.

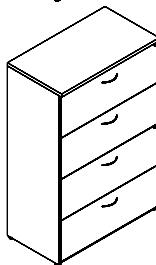

### 4 Drawer Lateral File (H3B handles, 2 locks) Anti-Tip Interlock

Model#	Depth	Width	Height	Weight	Cube	Price
20 MCLF204	20"	36"	55 1/16"	330	23	\$3,317
20 MCLF244	24"	36"	55 1/16"	335	28	\$3,466

REQUIRES 20 DAYS LEAD TIME. Lock positions are different from previous models.

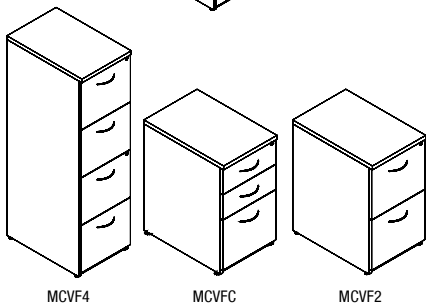

MCVF4

MCVFC

MCVF2

### Vertical Files (H3B handles, lock)

Model#	Depth	Width	Height	20"D Drawers	Weight	Cube	Price
☞ MCVF2	24"	16"	29"	2	160	7	\$1,175
☞ MCVFC	24"	16"	29"	3	160	7	\$1,290
MCVF2LGL	24"	19"	29"	2	172	8	\$1,325
20 MCVF4	24"	16"	55 1/16"	4	180	7	\$2,461
20 MCVF4LGL	24"	19"	55 1/16"	4	190	8	\$2,658

4 Drawer vertical files 2 locks. REQUIRES 20 DAYS LEAD TIME. Lock positions are different from previous models. Anti-tip interlock is standard on 4 drawer vertical files only.

**NOTE: All files recommended capacity is 75%, do not overload.**

For available accessories and upgrades, see pages 56–59.

# maverick series

## Pedestals - Freestanding

- NOTES:**
- Pedestals below cannot be used for Apex series. Email for quote.
  - Box/Box/File & File/File Pedestals are not recommended for Adjustable Desks.

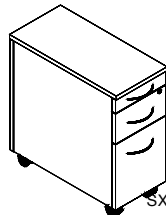
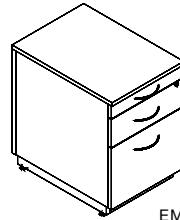
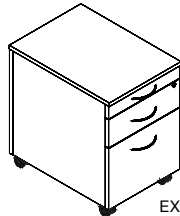
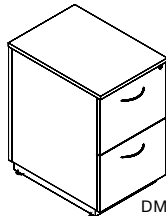
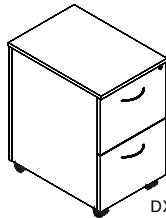
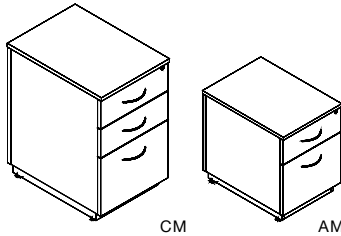
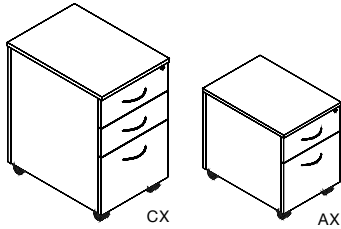

### Mobile Pedestal, Box/Box/File or Box/File with Casters (H3B handles, lock)

Model#	Depth	Width	Height	Drawer Depth	Weight	Cube	Price
MCPEDEX	23"	16"	22"	20"	56	5	\$1,052
MCPEDEX20	19"	16"	22"	16"	56	5	\$1,033
MCPEDCX	23"	16"	27 5/8"	20"	90	6	\$1,265
MCPEDCX20	19"	16"	27 5/8"	16"	80	6	\$1,246

### Pedestal, Box/Box/File or Box File with Kickbase 2 1/2"H. (H3B handles, right lock)

Model#	Depth	Width	Height	Drawer Depth	Weight	Cube	Price
MCPEDEX	23"	16"	22"	20"	50	4	\$1,052
MCPEDEX20	19"	16"	22"	16"	50	4	\$1,033
MCPEDCM	23"	16"	27 5/8"	20"	90	6	\$1,265
MCPEDCM20	19"	16"	27 5/8"	16"	80	6	\$1,246

1 Convenience tray (MMBPT) is provided for BBF. 1 file bar is provided. Fully finished, letter size.

### Mobile Pedestal, File/File with Casters (H3B handles, lock)

Model#	Depth	Width	Height	Drawer Depth	Weight	Cube	Price
MCPEDDX	23"	16"	27 5/8"	20"	90	6	\$1,215
MCPEDDX20	19"	16"	27 5/8"	16"	80	6	\$1,191

### Pedestal, File/File with Kickbase 2 1/2"H. (H3B handles, lock)

Model#	Depth	Width	Height	Drawer Depth	Weight	Cube	Price
MCPEDDM	23"	16"	27 5/8"	20"	90	6	\$1,215
MCPEDDM20	19"	16"	27 5/8"	16"	80	6	\$1,191

2 File bars are provided. Fully finished, letter size.

### Mobile Pedestal, Pencil/Box/File with Casters (H3B handles, Right lock)

Model#	Depth	Width	Height	Drawer Depth	Weight	Cube	Price
MCPEDEX	23"	16"	24"	20"	90	6	\$1,265
MCPEDEX20	19"	16"	24"	16"	80	6	\$1,246

### Pedestal, Pencil/Box/File with Kickbase 2 1/2" H. (H3B handles, lock)

Model#	Depth	Width	Height	Drawer Depth	Weight	Cube	Price
MCPEDEM	23"	16"	24"	20"	90	6	\$1,265
MCPEDEM20	19"	16"	24"	16"	80	6	\$1,246

Locks box/file only. 1 File bar provided. Fully finished, letter size.

### Slim Mobile Pedestal Pencil/Box/File (H3B handles, Right lock)

Model#	Depth	Width	Height	Drawer Depth	Weight	Cube	Price
MCPEDSX	23"	10 1/2"	24"	20"	90	5	\$1,265
MCPEDSX20	19"	10 1/2"	24"	16"	80	5	\$1,246

Locks box/file only. 1 File bar provided. Fully finished, letter size. H11 & H14 handles do not fit.

- NOTES:**
- Face lock location is standard on all pedestals.
  - APH1 handles do not fit on pencil drawers, N/A.

# maverick series

## Statement of Line

### RECEPTION

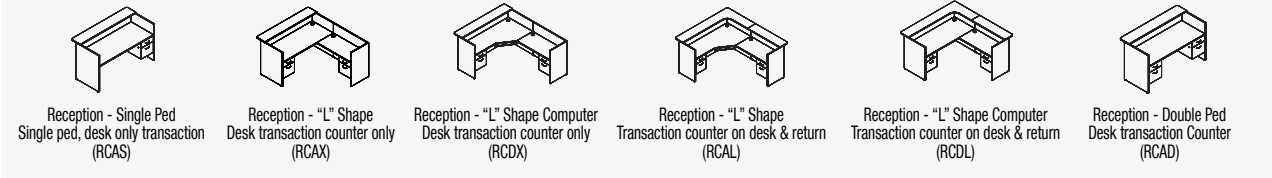

#### NOTES:

- Before ordering, ensure that the building and room access, including elevators, will accommodate furniture of this size. Use of pin-and-cam construction does facilitate some disassembly.
- Details of front transaction counter vary by series as do pedestals.
- Handles and locks standards vary by series.

## How to Order Reception Units

### WORKSURFACE UNITS: RECEPTION UNITS

1. Product number: **MC RCAL 36 72 L**

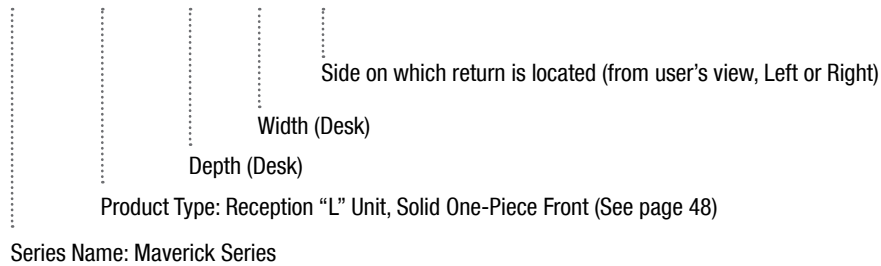

2. Specify worksurface color. Matching color edge and countertop is standard.
3. Specify counter top color. Matching color edge is standard.
4. Specify chassis color. Matching color edge is standard. Modesty color same as chassis is standard.
5. Specify drawer front color. Matching color edgeband only.
6. Specify handle option. H3B is standard if none specified. (Handles H11, H30, & APH1 charges apply)
7. Specify other accessories and upgrade options. See pages 54–59.

### STANDARD HANDLE OPTIONS

H3B is standard unless otherwise specified.



Crescent Black  
(MMH3B)



Crescent Silver  
(MMH3S)



Elliptical Black  
(MMH5B)



Elliptical Silver  
(MMH5S)



Crescent Textured Nickel  
(MMH6)



Flared Nickel  
(MMH7)



Bow Handle  
(MMH8)



Curved Handle  
(MMH9)



Bar Square Handle  
(MMH10B)



Bar Square Handle  
(MMH10S)



Bar Handle  
(MMH13)



Bar Handle  
(MMH14)



GROMMET

Black grommet standard where shown.  
Upgrade to silver color at no charge.

# maverick series

## Risers for Desks and Returns

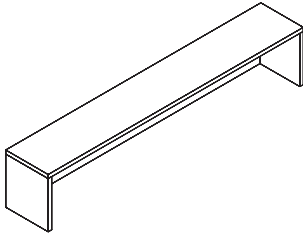

### Riser (No approach overhang)

Model#	Depth	Width	Height	Weight	Cube	Price
MCRB36	12"	36"	14"	38	1	\$540
MCRB42	12"	42"	14"	43	2	\$562
MCRB48	12"	48"	14"	47	5	\$605
MCRB60	12"	60"	14"	56	6	\$868
MCRB66	12"	66"	14"	61	7	\$985
MCRB72	12"	72"	14"	65	7	\$1,098

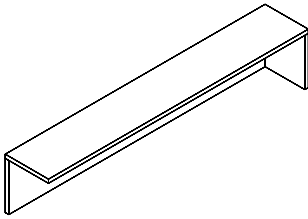

### Riser Return, Right (No approach overhang)

Model#	Depth	Width	Height	Weight	Cube	Price
MCRBR36R	12"	36"	14"	32	1	\$540
MCRBR42R	12"	42"	14"	37	2	\$562
MCRBR48R	12"	48"	14"	42	5	\$605
MCRBR54R	12"	54"	14"	47	6	\$735
MCRBR60R	12"	60"	14"	51	6	\$868
MCRBR66R	12"	66"	14"	56	7	\$985
MCRBR72R	12"	72"	14"	60	7	\$1,098

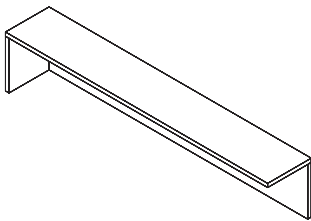

### Riser Return, Left (No approach overhang)

Model#	Depth	Width	Height	Weight	Cube	Price
MCRBR36L	12"	36"	14"	32	1	\$540
MCRBR42L	12"	42"	14"	37	2	\$562
MCRBR48L	12"	48"	14"	42	5	\$605
MCRBR54L	12"	54"	14"	47	6	\$735
MCRBR60L	12"	60"	14"	51	6	\$868
MCRBR66L	12"	66"	14"	56	7	\$985
MCRBR72L	12"	72"	14"	60	7	\$1,098

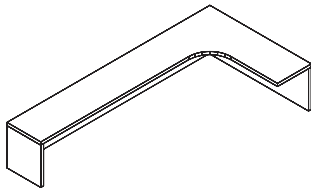

### Riser "L" Shape, Right Return (12" Deep, one piece countertop)

Model#	Depth	Width	Height	Weight	Cube	Price
MCRBL3072R	30"	72"	14"	88	18	\$1,409
MCRBL3672R	36"	72"	14"	92	21	\$1,605

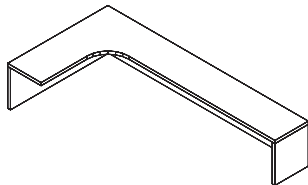

### Riser "L" Shape, Left Return (12" Deep, one piece countertop)

Model#	Depth	Width	Height	Weight	Cube	Price
MCRBL3072L	30"	72"	14"	88	18	\$1,409
MCRBL3672L	36"	72"	14"	92	21	\$1,605

### Notes on standard woodgrain directions:

- The front on the bridge or return unit will display the woodgrain running horizontally for 66" or larger.
- On other vertical surfaces, the woodgrain runs vertically.
- Worksurface woodgrain on bridge for desk runs left-to-right.
- The return countertop grain direction coordinates with the desk surface, running from user's side-to-approach side except on 66" to 72" returns.
- Risers are freestanding on worksurfaces.

# maverick series

## Risers, Desks and Returns

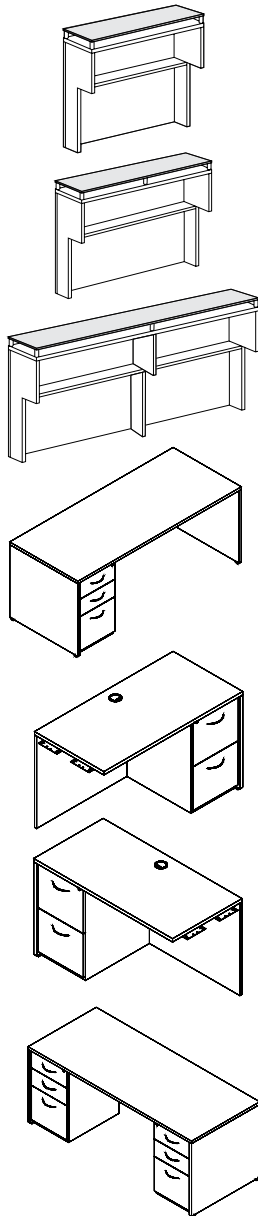

### Riser (Clear glass counter top, 4 aluminum spacers)

Model#	Depth	Width	Height	Weight	Cube	Price
MCRB3632G	12"	36"	32"	89	16	\$2,246

### Riser (Clear glass counter top, 6 aluminum spacers)

Model#	Depth	Width	Height	Weight	Cube	Price
MCRB4832G	12"	48"	32"	89	17	\$2,564

### Riser (Clear glass counter top, center leg support, 6 aluminum spacers)

Model#	Depth	Width	Height	Weight	Cube	Price
MCRB6032G	12"	60"	32"	92	20	\$3,204
MCRB7232G	12"	72"	32"	124	24	\$3,825

### Single Pedestal Desk Flush Full Modesty Panel, Box/Box/File (Specify left or right, H3B handles, lock)

Model#	Depth	Width	Height	Weight	Cube	Price
MCRSC3060R	30"	60"	29"	224	32	\$2,366
MCRSC3060L	30"	60"	29"	224	32	\$2,366
MCRSC3072R	30"	72"	29"	267	45	\$2,548
MCRSC3072L	30"	72"	29"	267	45	\$2,548

### Return Full Modesty Panel, File/File (Specify left or right, H3B handles, lock, 2 grommets)

Model#	Depth	Width	Height	Weight	Cube	Price
MCRRD2042R	20"	42"	29"	125	15	\$2,218
MCRRD2042L	20"	42"	29"	125	15	\$2,218
MCRRD2048R	20"	48"	29"	150	17	\$2,243
MCRRD2048L	20"	48"	29"	150	17	\$2,243
MCRRD2442R	24"	42"	29"	150	18	\$2,365
MCRRD2442L	24"	42"	29"	150	18	\$2,365
MCRRD2448R	24"	48"	29"	160	20	\$2,414
MCRRD2448L	24"	48"	29"	160	20	\$2,414

### Double Pedestal Desk, Flush Full Modesty Panel, Left and Right Box/Box/File (H3B handles, 2 locks)

Model#	Depth	Width	Height	Weight	Cube	Price
MCRDC3072	30"	72"	29"	314	38	\$3,353
MCRDC3672	36"	72"	29"	337	45	\$3,376

### Notes for risers, desks and returns:

- Flush modesty panel on desk. Pedestals on desks and returns are full pedestal to floor.
- Returns, black grommet center top and modesty
- Desks & Returns are designed (pin & cam) to accept risers. Risers add 6" to overall depth.
- Risers can be placed on desks of same width or longer width. For longer width, specify left or right.
- For Risers smaller than desk width: Must specify riser placement left or right.
- REQUIRES 4 WEEK LEAD TIME.

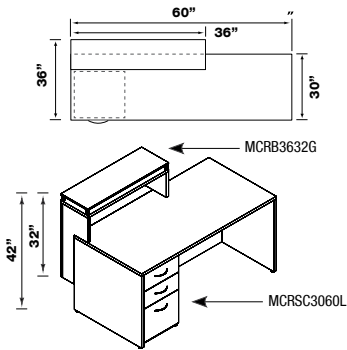
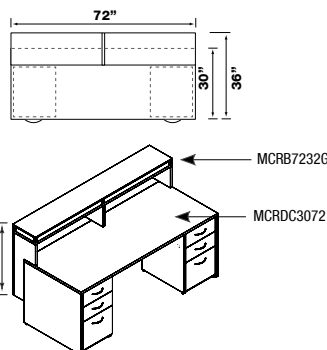
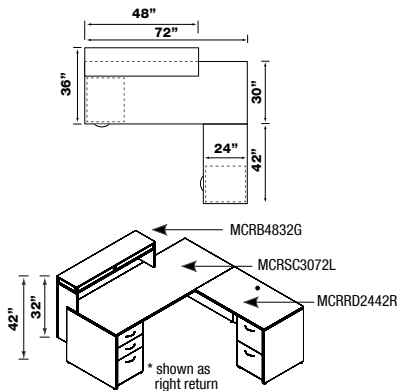

**NOTE: Risers are designed for the style of desks and returns on this page. Specify user left or right side riser placement.**

# maverick series

## Reception Units L-Shapes

### (Desk and Return with Transaction Countertop)

**NOTE:** Before ordering, ensure that the building and room access, including elevators, will accommodate furniture of this size. Use of pin-and-cam construction does facilitate some reassembly.

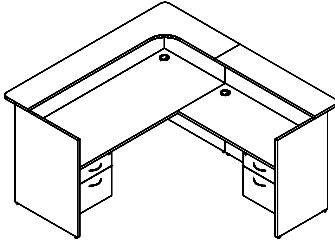

Reception "L" Unit, Solid One-Piece Front, Box/File, Right Return 24"x48"  
(2 Locks, H3B handles, 2 grommets)

Model#	Depth	Width	Height	Weight	Cube	Price
*MRCAL3060R	72"	66"	42"	400	92	\$4,800
MRCAL3072R	84"	78"	42"	435	104	\$5,133
MRCAL3672R	90"	78"	42"	439	115	\$5,326
MRCAL3684R	90"	90"	42"	522	127	\$5,766

Countertop is 12" deep. Counter top approach overhang is 6". Worksurface black grommets standard. Transaction counter to desktop clearance is 11 3/4". Upgrade grommet cover to silver at no charge. \*MRCAL3060R comes with a 20"x36" right return.

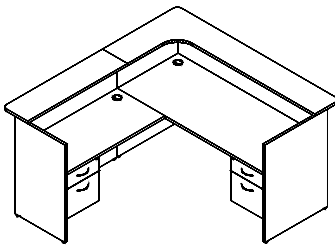

Reception "L" Unit, Solid One-Piece Front, Box/File, Left Return 24"x48"  
(2 Locks, H3B handles, 2 grommets)

Model#	Depth	Width	Height	Weight	Cube	Price
*MRCAL3060L	72"	66"	42"	400	92	\$4,800
MRCAL3072L	84"	78"	42"	435	104	\$5,133
MRCAL3672L	90"	78"	42"	439	115	\$5,326
MRCAL3684L	90"	90"	42"	522	127	\$5,766

Countertop is 12" deep. Counter top approach overhang is 6". Worksurface black grommets standard. Transaction counter to desktop clearance is 11 3/4". Upgrade grommet cover to silver at no charge. \*MRCAL3060L comes with a 20"x36" left return.

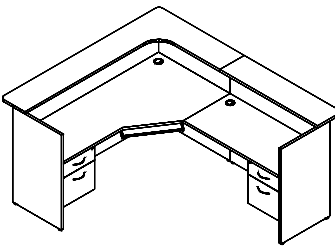

Computer Reception "L" Unit, Solid One-Piece Front, Box/File, Right Return 24"x48"  
(2 Locks, H3B handles, 2 grommets)

Model#	Depth	Width	Height	Weight	Cube	Price
MRCDL3672R	90"	78"	42"	435	88	\$5,326

Countertop is 12" deep. Counter top approach overhang is 6". Worksurface black grommets and keyboard tray standard. Transaction counter to desktop clearance is 11 3/4". Upgrade grommet cover to silver at no charge.

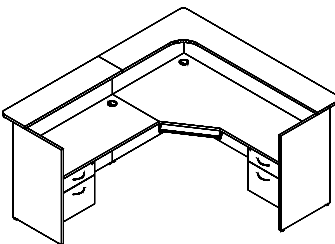

Computer Reception "L" Unit, Solid One-Piece Front, Box/File, Left Return 24"x48"  
(2 Locks, H3B handles, 2 grommets)

Model#	Depth	Width	Height	Weight	Cube	Price
MRCDL3672L	90"	78"	42"	435	88	\$5,326

Countertop is 12" deep. Counter top approach overhang is 6". Worksurface black grommets and keyboard tray standard. Transaction counter to desktop clearance is 11 3/4". Upgrade grommet cover to silver at no charge.

#### Notes on standard woodgrain directions:

- The one-piece vertical front on the desk of the unit will display the woodgrain running horizontally (except 60")
- On other vertical surfaces, the woodgrain runs vertically
- Worksurface woodgrain on desk runs left-to-right
- The return worksurface grain direction coordinates with the desk surface, running from user's side to the approach side
- Transaction counter woodgrain runs the same direction as the worksurface woodgrain

For available accessories and upgrades, see pages 54–59.

# maverick series

## Reception Units L-Shapes with Full Pedestals (Desk and Return with Transaction Countertop)

**NOTE:** Before ordering, ensure that the building and room access, including elevators, will accommodate furniture of this size. Use of pin-and-cam construction does facilitate some reassembly.

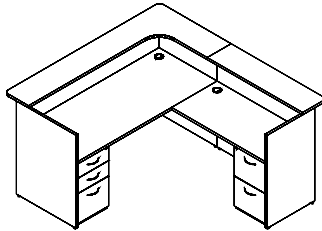

Reception "L" Unit, Solid One-Piece Front, Desk Box/Box/File & File/File Right Return 24"x48"  
(2 Locks, H3B handles, 2 grommets)

Model#	Depth	Width	Height	Weight	Cube	Price
*MRCALCD3060R	72"	66"	42"	415	92	\$5,643
MRCALCD3072R	84"	78"	42"	450	104	\$5,976
MRCALCD3672R	90"	78"	42"	454	115	\$6,169
MRCALCD3684R	90"	90"	42"	537	127	\$6,609

Countertop is 12" deep. Countertop approach overhang is 6". Worksurface black grommets standard. Transaction counter to desktop clearance is 11 3/4". Upgrade grommet cover to silver at no charge. \*MRCAL3060R comes with a 20"x36" right return.

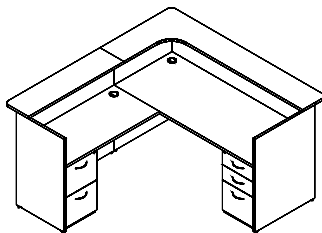

Reception "L" Unit, Solid One-Piece Front, Desk Box/Box/File & File/File Left Return 24"x48"  
(2 Locks, H3B handles, 2 grommets)

Model#	Depth	Width	Height	Weight	Cube	Price
*MRCALCD3060L	72"	66"	42"	415	92	\$5,643
MRCALCD3072L	84"	78"	42"	450	104	\$5,976
MRCALCD3672L	90"	78"	42"	454	115	\$6,169
MRCALCD3684L	90"	90"	42"	537	127	\$6,609

Countertop is 12" deep. Countertop approach overhang is 6". Worksurface black grommets standard. Transaction counter to desktop clearance is 11 3/4". Upgrade grommet cover to silver at no charge. \*MRCAL3060L comes with a 20"x36" left return.

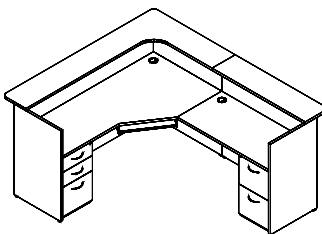

Computer Reception "L" Unit, Solid One-Piece Front, Desk Box/Box/File and File/File Right Return 24"x48"  
(2 Locks, H3B handles, 2 grommets)

Model#	Depth	Width	Height	Weight	Cube	Price
MRCDLCD3672R	90"	78"	42"	450	88	\$6,169

Countertop is 12" deep. Countertop approach overhang is 6". Worksurface black grommets and keyboard tray standard. Transaction counter to desktop clearance is 11 3/4". Upgrade grommet cover to silver at no charge.

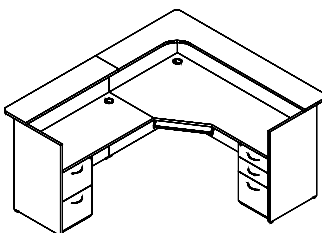

Computer Reception "L" Unit, Solid One-Piece Front, Desk Box/Box/File and File/File Left Return 24"x48"  
(2 Locks, H3B handles, 2 grommets)

Model#	Depth	Width	Height	Weight	Cube	Price
MRCDLCD3672L	90"	78"	42"	450	88	\$6,169

Countertop is 12" deep. Countertop approach overhang is 6". Worksurface black grommets and keyboard tray standard. Transaction counter to desktop clearance is 11 3/4". Upgrade grommet cover to silver at no charge.

### Notes on standard woodgrain directions:

- The one-piece vertical front on the desk of the unit will display the woodgrain running horizontally (except 60")
- On other vertical surfaces, the woodgrain runs vertically
- Worksurface woodgrain on desk runs left-to-right
- The return worksurface grain direction coordinates with the desk surface, running from user's side to the approach side
- Transaction counter woodgrain runs the same direction as the worksurface woodgrain

For available accessories and upgrades, see pages 54–59.



# maverick series

## Reception Units L-Shapes & Reception Desks

### (Desk-only with Transaction Countertop)

**NOTE:** Before ordering, ensure that the building and room access, including elevators, will accommodate furniture of this size. Use of pin-and-cam construction does facilitate some reassembly.

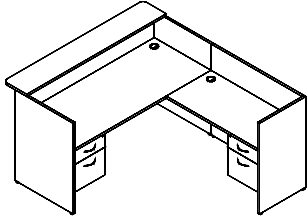

Reception "L" Unit, Solid One-Piece Front, Box/File Right Return 24"x48"\*  
(Desk-only with countertop, 2 locks, H3B handles, 2 grommets)

Model#	Depth	Width	Height	Weight	Cube	Price
*MCRCA3060R	72"	60"	42"	390	92	\$4,507
MCRCA3072R	84"	72"	42"	425	92	\$4,768
MCRCA3672R	90"	72"	42"	430	92	\$5,255

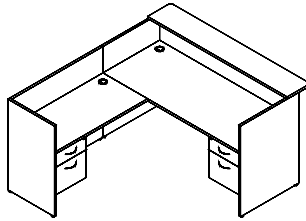

Reception "L" Unit, Solid One-Piece Front, Box/File Left Return 24"x48"\*  
(Desk-only with countertop, 2 locks, H3B handles, 2 grommets)

Model#	Depth	Width	Height	Weight	Cube	Price
*MCRCA3060L	72"	60"	42"	390	92	\$4,507
MCRCA3072L	84"	72"	42"	425	92	\$4,768
MCRCA3672L	90"	72"	42"	430	92	\$5,255

Countertop is 12" deep. Countertop approach overhang is 6". Worksurface black grommets standard.  
Transaction counter to desktop clearance is 11 3/4".  
\*MMRCA3060 comes with a 20"x 36" return. Upgrade grommet cover to silver at no charge.

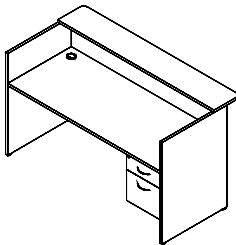

Reception Single Pedestal Desk, Box/File Right (Desk with countertop, lock, H3B handles, left grommet)

Model#	Depth	Width	Height	Weight	Cube	Price
MRCAS3060R	36"	60"	42"	232	53	\$2,933
MRCAS3072R	36"	72"	42"	250	63	\$3,065

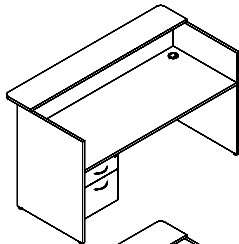

Reception Single Pedestal Desk, Box/File Left (Desk with countertop, lock, H3B handles, right grommet)

Model#	Depth	Width	Height	Weight	Cube	Price
MRCAS3060L	36"	60"	42"	232	53	\$2,933
MRCAS3072L	36"	72"	42"	250	63	\$3,065

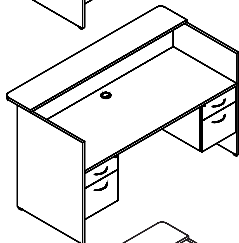

Reception Double Pedestal Desk, Left & Right Box/File  
(Desk with countertop, H3B handles, 2 locks, center grommet)

Model#	Depth	Width	Height	Weight	Cube	Price
MRCAD3072	36"	72"	42"	250	63	\$3,641

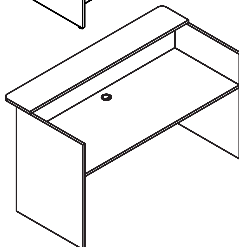

Reception Desk Shell (Desk with counter top) Center Grommet

Model#	Depth	Width	Height	Weight	Cube	Price
MRCAN3060	36"	60"	42"	186	53	\$2,310
MRCAN3072	36"	72"	42"	210	63	\$2,436

Countertop is 12" deep. Countertop approach overhang is 6". Worksurface black grommets standard.  
Transaction counter to desktop clearance is 11 3/4".  
Upgrade grommet cover to silver at no charge.

#### Notes on standard woodgrain directions:

- The one-piece vertical front on the desk of the unit will display the woodgrain running horizontally (except 60")
- On other vertical surfaces, the woodgrain runs vertically
- Worksurface woodgrain on desk runs left-to-right
- The return worksurface grain direction coordinates with the desk surface, running from user's side to the approach side
- Transaction counter woodgrain runs the same direction as the worksurface woodgrain

For available accessories and upgrades, see pages 54–59.

# maverick series

## Reception Units L-Shapes and Reception Desks with Full Pedestals (Desk-only Transaction with Countertop)

**NOTE:** Before ordering, ensure that the building and room access, including elevators, will accommodate furniture of this size. Use of pin-and-cam construction does facilitate some reassembly.

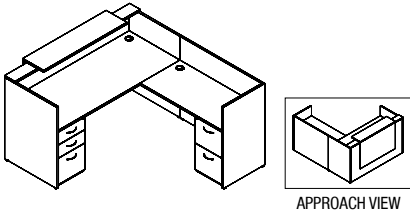

Reception "L" Unit with Riser, Solid One-Piece Front, Desk Box/Box/File and File/File Right Return 24"x48" (Desk-only with countertop & riser, 2 locks, H3B handles, 2 grommets)

Model#	Depth	Width	Height	Weight	Cube	Price
MCRCRBCD3072R	79 1/2"	72"	43 3/4"	525	92	\$6,492

Countertop is 6" deep. Riser with 2" inset undertrim: 12"Dx48"Wx32"H (Undertrim color same as base). Riser ships assembled to desk. Overall height 43 3/4". Worksurface black grommets standard. Transaction counter to desktop clearance is 11 3/4". Upgrade grommet cover to silver at no charge.

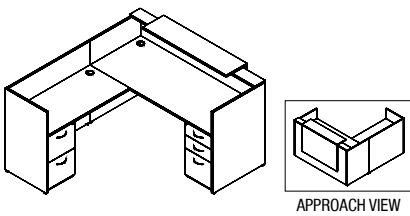

Reception "L" Unit with Riser, Solid One-Piece Front, Desk Box/Box/File and File/File Left Return 24"x48" (Desk-only with countertop & riser, 2 locks, H3B handles, 2 grommets)

Model#	Depth	Width	Height	Weight	Cube	Price
MCRCRBCD3072L	79 1/2"	72"	43 3/4"	525	92	\$6,492

Countertop is 6" deep. Riser with 2" inset undertrim: 12"Dx48"Wx32"H (Undertrim color same as base). Riser ships assembled to desk. Overall height 43 3/4". Worksurface black grommets standard. Transaction counter to desktop clearance is 11 3/4". Upgrade grommet cover to silver at no charge.

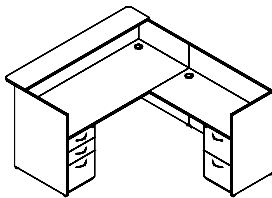

Reception "L" Unit, Solid One-Piece Front, Desk Box/Box/File & File/File Right Return 24"x48" (Desk-only with countertop, 2 locks, H3B handles, 2 grommets)

Model#	Depth	Width	Height	Weight	Cube	Price
*MCRCAxCD3060R	72"	60"	42"	405	92	\$5,351
MCRCAxCD3072R	84"	72"	42"	440	92	\$5,611
MCRCAxCD3672R	90"	72"	42"	445	92	\$6,099

Countertop is 12" deep. Counter top approach overhang is 6". Worksurface black grommets standard. Transaction counter to desktop clearance is 11 3/4". \*MMRCAx3060 comes with a 20"x 36" return. Upgrade grommet cover to silver at no charge.

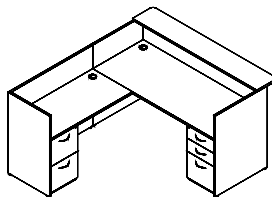

Reception "L" Unit, Solid One-Piece Front, Desk Box/Box/File & File/File Left Return 24"x48" (Desk-only with countertop, 2 locks, H3B handles, 2 grommets)

Model#	Depth	Width	Height	Weight	Cube	Price
*MCRCAxCD3060L	72"	60"	42"	405	92	\$5,351
MCRCAxCD3072L	84"	72"	42"	440	92	\$5,611
MCRCAxCD3672L	90"	72"	42"	445	92	\$6,099

Countertop is 12" deep. Counter top approach overhang is 6". Worksurface black grommets standard. Transaction counter to desktop clearance is 11 3/4". \*MMRCAx3060 comes with a 20"x 36" return. Upgrade grommet cover to silver at no charge.

### Notes on standard woodgrain directions:

- The one-piece vertical front on the desk of the unit will display the woodgrain running horizontally (except 60")
- On other vertical surfaces, the woodgrain runs vertically
- Worksurface woodgrain on desk runs left-to-right
- The return worksurface grain direction coordinates with the desk surface, running from user's side to the approach side
- Transaction counter woodgrain runs the same direction as the worksurface woodgrain

For available accessories and upgrades, see pages 54–59.

# maverick series

## Reception Desks with Full Pedestals

### (Desk-only Transaction with Countertop)

**NOTE:** Before ordering, ensure that the building and room access, including elevators, will accommodate furniture of this size. Use of pin-and-cam construction does facilitate some reassembly.

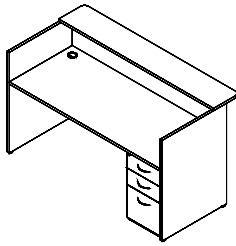

**Reception Single Pedestal Desk, Box/Box/File Right**  
(Desk with countertop, lock, H3B handles, left grommet)

Model#	Depth	Width	Height	Weight	Cube	Price
MRCASC3060R	36"	60"	42"	247	53	\$3,386
MRCASC3072R	36"	72"	42"	265	63	\$3,518

Countertop is 12" deep. Counter top approach overhang is 6". Worksurface black grommets standard.  
Transaction counter to desktop clearance is 11 3/4".  
Upgrade grommet cover to silver at no charge.

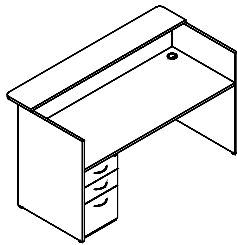

**Reception Single Pedestal Desk, Box/Box/File Left**  
(Desk with countertop, lock, H3B handles, right grommet)

Model#	Depth	Width	Height	Weight	Cube	Price
MRCASC3060L	36"	60"	42"	247	53	\$3,386
MRCASC3072L	36"	72"	42"	265	63	\$3,518

Countertop is 12" deep. Counter top approach overhang is 6". Worksurface black grommets standard.  
Transaction counter to desktop clearance is 11 3/4".  
Upgrade grommet cover to silver at no charge.

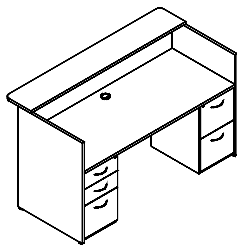

**Reception Double Pedestal Desk, Left & Right Box/File**  
(Desk with countertop, H3B handles, 2 locks, center grommet)

Model#	Depth	Width	Height	Weight	Cube	Price
MRCADCD3072	36"	72"	42"	265	63	\$4,484

Countertop is 12" deep. Counter top approach overhang is 6". Worksurface black grommets standard.  
Transaction counter to desktop clearance is 11 3/4".  
Upgrade grommet cover to silver at no charge.

#### Notes on standard woodgrain directions:

- The one-piece vertical front on the desk of the unit will display the woodgrain running horizontally (except 60")
- On other vertical surfaces, the woodgrain runs vertically
- Worksurface woodgrain on desk runs left-to-right
- The return worksurface grain direction coordinates with the desk surface, running from user's side to the approach side
- Transaction counter woodgrain runs the same direction as the worksurface woodgrain

For available accessories and upgrades, see pages 54–59.

# maverick series

## Reception Units Computer L-Shapes Desk & Return

### (Desk-only with Transaction Countertop)

**NOTE:** Before ordering, ensure that the building and room access, including elevators, will accommodate furniture of this size. Use of pin-and-cam construction does facilitate some reassembly.

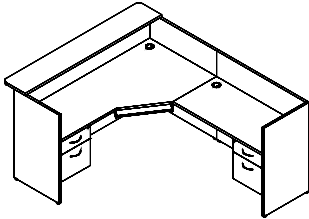

Computer Reception "L" Unit, Solid One-Piece Front, Box/File Right Return 24"x48"  
(Desk-only with countertop, 2 locks, H3B handles, 2 grommets)

Model#	Depth	Width	Height	Weight	Cube	Price
MCRCDX3672R	90"	72"	42"	425	88	\$4,768

Countertop is 12" deep. Countertop approach overhang is 6". Worksurface black grommets and keyboard tray standard. Desk counter only. Transaction counter-to-desktop clearance is 11 3/4". Upgrade grommet cover to silver at no charge.

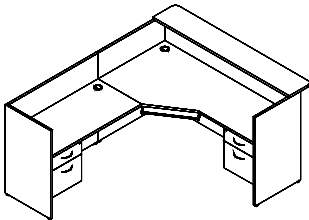

Computer Reception "L" Unit, Solid One-Piece Front, Box/File Left Return 24"x48"  
(Desk-only with countertop, 2 locks, H3B handles, 2 grommets)

Model#	Depth	Width	Height	Weight	Cube	Price
MCRCDX3672L	90"	72"	42"	425	88	\$4,768

Countertop is 12" deep. Countertop approach overhang is 6". Worksurface black grommets and keyboard tray standard. Desk counter only. Transaction counter-to-desktop clearance is 11 3/4". Upgrade grommet cover to silver at no charge.

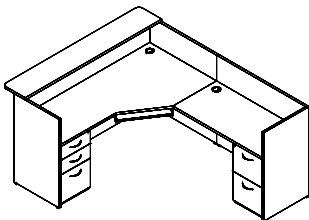

Computer Reception "L" Unit, Solid One-Piece Front, Desk Box/Box/File & File/File Right Return 24"x48"  
(Desk-only with countertop, 2 locks, H3B handles, 2 grommets)

Model#	Depth	Width	Height	Weight	Cube	Price
MCRCDXCD3672R	90"	72"	42"	440	88	\$5,611

Countertop is 12" deep. Countertop approach overhang is 6". Worksurface black grommets and keyboard tray standard. Desk counter only. Transaction counter-to-desktop clearance is 11 3/4". Upgrade grommet cover to silver at no charge.

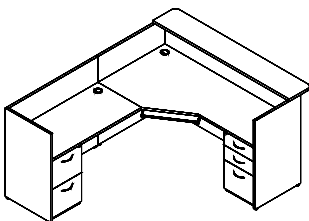

Computer Reception "L" Unit, Solid One-Piece Front, Desk Box/Box/File & File/File Left Return 24"x48"  
(Desk-only with countertop, 2 locks, H3B handles, 2 grommets)

Model#	Depth	Width	Height	Weight	Cube	Price
MCRCDXCD3672L	90"	72"	42"	440	88	\$5,611

Countertop is 12" deep. Countertop approach overhang is 6". Worksurface black grommets and keyboard tray standard. Desk counter only. Transaction counter-to-desktop clearance is 11 3/4". Upgrade grommet cover to silver at no charge.

#### Notes on standard woodgrain directions:

- The one-piece vertical front on the desk of the unit will display the woodgrain running horizontally (except 60")
- On other vertical surfaces, the woodgrain runs vertically
- Worksurface woodgrain on desk runs left-to-right
- The return worksurface grain direction coordinates with the desk surface, running from user's side to the approach side
- Transaction counter woodgrain runs the same direction as the worksurface woodgrain

For available accessories and upgrades, see pages 54–59.

# maverick series

## Upgrades and Accessories for Receptions

### STANDARD HANDLE OPTIONS FOR RECEPTION UNITS

H3B is standard if none specified.



Crescent Black  
(MMH3B)



Crescent Silver  
(MMH3S)



Elliptical Black  
(MMH5B)



Elliptical Silver  
(MMH5S)



Crescent Textured Nickel  
(MMH6)



Flared Nickel  
(MMH7)



Bow Handle  
(MMH8)



Curved Handle  
(MMH9)



Bar Square Handle  
(MMH10B)



Bar Square Handle  
(MMH10S)



Bar Handle  
(MMH13)



Bar Handle  
(MMH14)



### Upgrade Grommet Color from Standard Black to Silver

Model#	Color	Depth	Width	Surface Hole Diameter	Price
MMUGR234	Silver Plastic	3"	3"	2 3/4"	No Charge

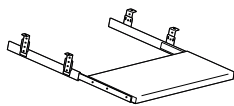

### Keyboard Tray, Rollout (Specify laminate color)

Model#	Depth	Width	Height	Weight	Cube	Price
MMKB	16"	21"	3"	10	.5	\$204

# maverick series

## Upgrades and Accessories for Hutches

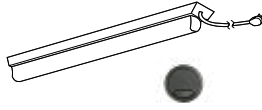

### Tasklight (Black, one light only) One Grommet on Hutch Back Panel

Model#	Depth	Width	Height	Weight	Cube	Price
MCTSKLTX	7/8"	24 1/2"	1 7/8"	2	.1	\$364

72" Hutch takes 2 lights. For extra tasklight add MMTSKLTX \$280.

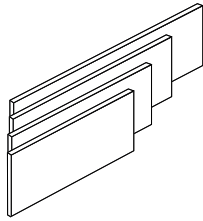

### Hutch Tackboards

Model#	Depth	Width	Height	Hutch Width	Weight	Cube	Price
MMTKBD30	1/2"	30"	14 1/4"	36"	9	.5	\$590
MMTKBD36	1/2"	36"	14 1/4"	42"	9	.5	\$612
MMTKBD42	1/2"	42"	14 1/4"	48"	12	.6	\$634
MMTKBD48	1/2"	48"	14 1/4"	54"	12	.6	\$682
MMTKBD54	1/2"	54"	14 1/4"	60"	15	.7	\$725
MMTKBD60	1/2"	60"	14 1/4"	66"	17	.8	\$771
MMTKBD66	1/2"	66"	14 1/4"	72"	19	1	\$824
MMTKBD72	1/2"	72"	14 1/4"	78"	21	1	\$1,006

Tackboards fit hutch width 6" larger, e.g., MMTKBD66 fits 72" wide hutch.

For fabric color choice, see inside back cover.

For COM fabric, add \$249 list each tackboard. Required yardage to be provided by customer.

### Fabric Chart (Uses Guilford of Maine)

#### STANDARD FABRICS

**Tempest 2120**...Zebra 015, **Sprite 2671**...Snow 7040, Linen 7010

**Anchorage 2335**...Sunshine 2082, Waterfall 2691, Green Apple 2087, Aubergine 2036, Goose 2049, Onyx 2016, Red Delicious 2014

**Metro 3077**... Skyscraper 022 **Cape Cod 3073**...Linen 7031, Surf 7062

**Metallation 5118**...Chrome 1676, Polished Pewter 1678

**Phrase 9508**...Maize 3010, Truffle 3050, Shale 3070, Sprout 3020, Marine 3030, Cayenne 3040, Poolside 3031

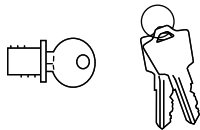

### Face Lock for Hutch Doors

Model#	Depth	Width	Height	Weight	Cube	Price
MMFL						\$118

1 Per set of 2 doors. Hutch with 4 doors takes 2 locks. Locks N/A for Glass Doors.

# maverick series

## Accessories and Upgrades

### STANDARD HANDLE OPTIONS

H3B is standard if none specified.



Crescent Black  
(MMH3B)



Crescent Silver  
(MMH3S)



Elliptical Black  
(MMH5B)



Elliptical Silver  
(MMH5S)



Crescent Textured Nickel  
(MMH6)



Flared Nickel  
(MMH7)



Bow Handle  
(MMH8)



Curved Handle  
(MMH9)



Bar Square Handle  
(MMH10B)



Bar Square Handle  
(MMH10S)



Bar Handle  
(MMH13)



Bar Handle  
(MMH14)

### GROMMETS



#### Grommet

Model#	Color	Depth	Width	Surface Hole Diameter	Price
MMGR234B	Black Plastic	3"	3"	2 3/4"	\$73
MMGR234S	Silver Plastic	3"	3"	2 3/4"	\$73
MMGR234BCOVER	Grommet cover only, Black (Field Install)				\$37
MMGR234SCOVER	Grommet cover only, Silver (Field Install)				\$37

#### Grommet Color, Upgrade from Standard Black to Silver

Model#	Color	Depth	Width	Surface Hole Diameter	Price
MMUGR234S	Silver Plastic	3"	3"	2 3/4"	No Charge

### GROMMETS LOCATION (Worksurface and modesty)

**NOTE:** While sitting at unit, grommet locations named from left to right.  
For grommet location on tops and/or modesty panel specify left, center or right.  
**No grommets over pedestals.**

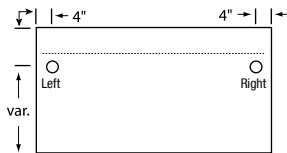

Desks

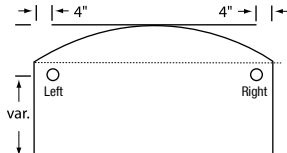

Desks

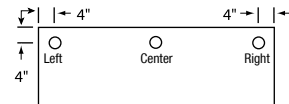

Credenza, Return, Bridges

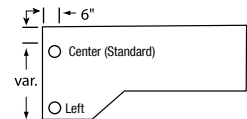

CompuCredenza

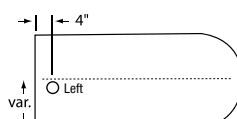

Bullets

**Note:** Black grommets are standard where shown on line drawings.

# maverick series

## Accessories and Upgrades

Specify standard handle selection at no charge, from H3B-H10B, H13 & H14.  
For handles H11, H30 and APH1 charges apply, see below.  
Add optional handles to hutches & wall mount cabinets.



### Crescent Handle, Metal - Black or Silver Finish

Model#	Hole Center	Width	Color	Price
☞ MMH3B	5"	5 3/4"	Black	\$43
☞ MMH3S	5"	5 3/4"	Silver	\$43



### Elliptical Handle, Metal - Black or Silver Finish

Model#	Hole Center	Width	Color	Price
☞ MMH5B	5"	6 3/4"	Black	\$43
☞ MMH5S	5"	6 3/4"	Silver	\$43



### Crescent Textured Nickel Handle, Metal - Silver Finish

Model#	Hole Center	Width	Price
☞ MMH6	5"	6 1/4"	\$43



### Flared Nickel Handle, Metal - Silver Finish

Model#	Hole Center	Width	Price
☞ MMH7	5"	6 1/4"	\$43



### Bow Handle, Silver Finish

Model#	Hole Center	Width	Price
☞ MMH8	5"	6 1/8"	\$43



### Curved Handle, Silver Finish

Model#	Hole Center	Width	Price
☞ MMH9	5"	6 1/2"	\$43



### Bar Square Handle, Black or Silver Finish

Model#	Hole Center	Width	Color	Price
☞ MMH10B	5"	5 3/8"	Black	\$43
☞ MMH10S	5"	5 3/8"	Silver	\$43



### Bar Square Handle, Silver Finish

Model#	Hole Center	Width	Price
MMH11	11"	11 3/8"	\$94/ea.

MMH11 handles full upgrade charges apply.



### Bar Handle, Silver Finish

Model#	Hole Center	Width	Price
☞ MMH13	5"	8"	\$43
☞ MMH14	11"	14"	\$43
MMH30*	27"	30"	\$94/ea.

MMH30\* handles DO NOT fit on pedestal drawers or hutch doors. Full upgrade charges apply for MMH30.



### Curved Edge Handle, Brushed Aluminum Finish

Model#	Hole Center	Width	Price
APH1	1 5/8"	7 7/8"	\$84/ea.

Extends ☞ lead time. Full upgrade charges apply.

When ordering APH1 handles for personal lateral files, (1) lock is standard — locks file & lateral file only.



# maverick series

## Accessories and Upgrades

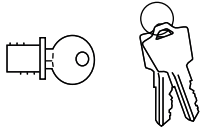

### Face Lock

Model#	Description	Price
MMFL	Face lock for TFM doors or center drawers	\$118

MMFL: 1 per set of 2 doors. Hutch with 4 doors requires 2 locks.  
 MMFLL: For B/F, F/F & B/B/F Pedestals. (Full face lock is standard on all pedestals)  
 Lock numbers (#101-115) are randomly assigned, key alike must be specify. No charge.



### Face Lock Accessories

Model#	Description	Price
MM-CORE-KEYS	Lock core & 1 set of keys	\$67
MM-MASTER KEY	Unlocks Maverick locks	\$88
MMREMOVAL KEY	Removes Maverick lock cores	\$88

For core/keys replacement: Specify lock/key number and core color.  
 Set of keys are not sold separately (keys ship with core).

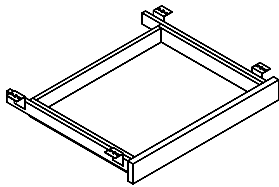

### Center Drawer (9-Ply birch wood drawer interior, specify front laminate color)

Model#	Depth	Width	Height	Weight	Cube	Price
MMCD	16"	21"	2 1/2"	12	.5	\$224



### Box Drawer Convenience Tray, Black (Insets to box drawer)

Model#	Depth	Width	Height	Weight	Cube	Price
MMBPT	5 1/2"	12"	1"	1	.5	\$43

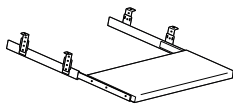

### Keyboard Tray, Rollout (Specify laminate color)

Model#	Depth	Width	Height	Weight	Cube	Price
MMKB	16"	21"	3"	10	.5	\$204

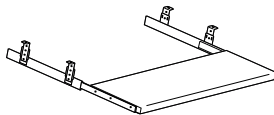

### Oversize Keyboard Tray, Rollout (Specify laminate color)

Model#	Depth	Width	Height	Weight	Cube	Price
MMKBLG	16"	28"	3"	12	.5	\$301

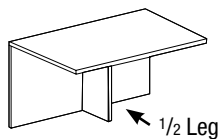

### Half-Leg Support with Leveler (Finished 3 sides)

Model#	Depth	Width	Height	Weight	Cube	Price
MMSPT	12"	1"	28"	11	3	\$97

Ships separately for field install. May be purchased for extra support. Center support only.

## Accessories and Upgrades

### Color Upgrade

#### Modesty or Back Panel Color Upgrade (Standard colors TFM only)

Model#	Description	TFM Color	Price
MMMOD2	Other standard color (Upgrade <b>modesty color</b> on desks, bridges, returns & credenzas)	Modesty	No Charge
MMCPF	Color Programming Fee (Upgrade <b>back panel</b> to other standard color on hutches, bookcase hutches, bookcases, bookcase with storage cabinet and bookcase with lateral file only)	Back Panel	\$172

N/A for adjustable shelves. Refer to color options for Maverick 20 standard colors. Color programming fee charges apply to all series accordingly.

### Cut Charges

#### Standard Cuts and Reprogramming Charges (Extends lead time)

Model#	Maverick Series Only	Price
MMCUT1	1-Cut, Height or Width or Depth, 90° Cut on 90° Pieces	\$150
MMCUT2	2-Cuts, Two Dimensions, 90° Cuts on 90° Pieces	\$234
MMCUT3	Program charge on piece with cut other than 90°	\$234
MMCUT3GR	Program charge grommet removal (each)	\$81

Extends ☞ lead time. For Maverick Series cut charges items only. Cut charges vary by product series, contact us to verify.

### Carton

#### Cartoning Charges (Extends leadtime) Optional

Model#		Price
MMCAR1	Bubble Wrap (Bubble and shrink wrap around product)	7%
MMCAR2	Packaging (Corner & edge protectors w/bubble & shrink wrap)	10%
MMCAR3	Full Cartoning (Corner & edge protectors w/bubble, shrink wrap & place in carton)	20%
MMCAR4	Pallet Cartoning (Corner & edge protectors w/bubble/shrink wrap, place in carton, strap to pallet)	25%

Cartoning is optional. Maverick product ships blanket wrapped.

# maverick series

## Adjustable Desks



Custom sizes available through our Design Department.

# maverick series

## Adjustable Desks **20** DAYS

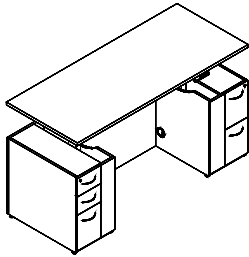

Height Adjustable Double Pedestal Desk Full Modesty, Left BBF & Right FF (H3B handles, 2 locks)

Model#	Depth	Width	Height	Adj Base	Weight	Cube	Price
MCHADCD3072	30"	72"	29"	MMLEGAHE24S3	314	38	\$7,284

Note: Adjustable Desk is designed to fit our Adjustable 3 Stage Base only. Silver Base is included. Must use Maverick Bases only. Base Boxes include left & right grommet. Full Modesty inset 6". (H11 & H14 do not fit)

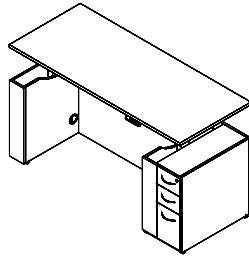

Height Adjustable Single Pedestal Desk Full Modesty, Right BBF (H3B handles, lock)

Model#	Depth	Width	Height	Adj Base	Weight	Cube	Price
MCHASC3072R	30"	72"	29"	MMLEGAHE24S3	210	38	\$6,342

Note: Adjustable Desk is designed to fit our Adjustable 3 Stage Base only. Silver Base is included. Must use Maverick Bases only. Base Boxes include left & right grommet. Full Modesty inset 6". (H11 & H14 do not fit)

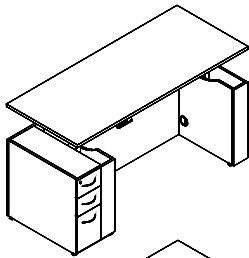

Height Adjustable Single Pedestal Desk Full Modesty, Left BBF (H3B handles, lock)

Model#	Depth	Width	Height	Adj Base	Weight	Cube	Price
MCHASC3072L	30"	72"	29"	MMLEGAHE24S3	210	38	\$6,342

Note: Adjustable Desk is designed to fit our Adjustable 3 Stage Base only. Silver Base is included. Must use Maverick Bases only. Base Boxes include left & right grommet. Full Modesty inset 6". (H11 & H14 do not fit)

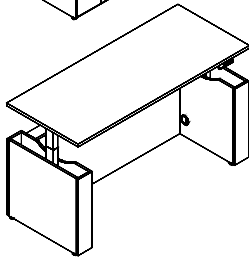

Height Adjustable Desk Shell, Full Modesty

Model#	Depth	Width	Height	Adj Base	Weight	Cube	Price
MCHAN3072	30"	72"	29"	MMLEGAHE24S3	138	38	\$3,948

Note: Adjustable Desk is designed to fit our Adjustable 3 Stage Base only. Silver base is included. Must use Maverick Bases only. Base Boxes include left & right grommet. Full Modesty inset 6".

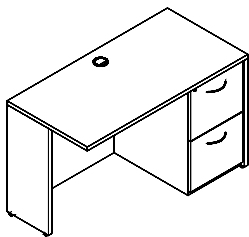

Freestanding Return Full Modesty, Right FF and Left Half Leg (H3B handles, lock)

Model#	Depth	Width	Height	Weight	Cube	Price
MCHARD2448R	24"	48"	29"	160	20	\$2,277

Black grommet center top and modesty panel, upgrade grommet to silver at no charge.

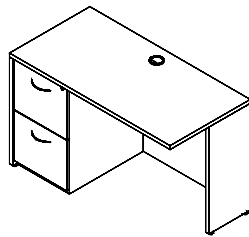

Freestanding Return Full Modesty, Left FF and Right Half Leg (H3B handles, lock)

Model#	Depth	Width	Height	Weight	Cube	Price
MCHARD2448L	24"	48"	29"	160	20	\$2,277

Black grommet center top and modesty panel, upgrade grommet to silver at no charge.

### NOTES:

- Adjustable desks ship knock-down.
- Adjustable bases cannot be substituted with another manufacturer's base.
- For adjustable base color options, see page 62.
- For freestanding return options, see pages 26–28.
- Custom sizes available, email our Design Department.

# maverick series

## Freestanding Returns **20** DAYS

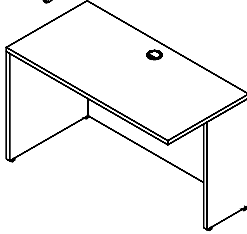
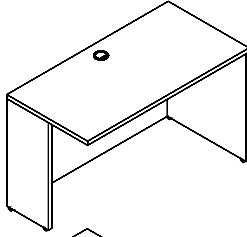

### Freestanding Right Return Shell Full Modesty, Left Half Leg

Model#	Depth	Width	Height	Weight	Cube	Price
MCHARN2448R	24"	48"	29"	74	20	\$1,158

Black grommet center top and modesty panel, upgrade grommet to silver at no charge.

### Freestanding Left Return Shell Full Modesty, Right Half Leg

Model#	Depth	Width	Height	Weight	Cube	Price
MCHARN2448L	24"	48"	29"	74	20	\$1,158

Black grommet center top and modesty panel, upgrade grommet to silver at no charge.

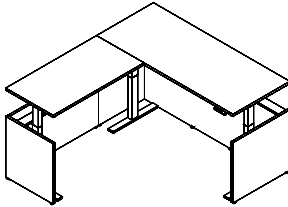
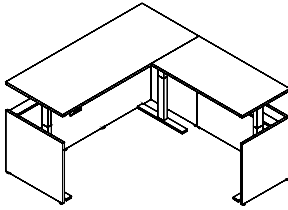

### Height Adjustable L-Shape Desk and Return Shell, Full Modesty, Right Return

Model#	Desk	Return	Height	Weight	Cube	Price
MCHALN30722448R	30"D x 72"W	24"D x 48"W	29"	212	58	\$5,672

MMLEGAHEL24S3 silver base is included. Must use Maverick Bases only. Ships knock-down.

Note: Adjustable Desk is designed to fit our 24" Adjustable 3 Stage L-Base only. Full Modesty inset 6".

### Height Adjustable L-Shape Desk and Return Shell, Full Modesty, Left Return

Model#	Desk	Return	Height	Weight	Cube	Price
MCHALN30722448L	30"D x 72"W	24"D x 48"W	29"	212	58	\$5,672

MMLEGAHEL24S3 silver base is included. Must use Maverick Bases only. Ships knock-down.

Note: Adjustable Desk is designed to fit our 24" Adjustable 3 Stage L-Base only. Full Modesty inset 6".

## Height Adjustable Bases 3 Stage

(Included in adjustable desks, standard silver color)

Bases cannot be substituted with another manufacturer's base.

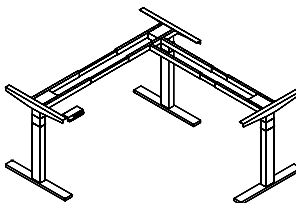
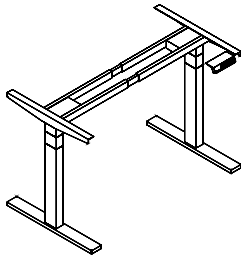

### Adjustable Height Electrical Base 3 Stage (Color choices)

Model#	Base (D)	Base (W)	Height	Color	Weight	Cube	Price
MMLEGAHE24S3	22"	47-72"	23 1/2" - 49"	Silver	66	1	Standard
MMLEGAHE24B3	22"	47-72"	23 1/2" - 49"	Black	66	1	No Upcharge
MMLEGAHE24W3	22"	47-72"	23 1/2" - 49"	White	66	1	No Upcharge

Bases ship unassembled. For black or white adj base must specify model# and color on order.

### Adjustable Height Electrical L-Base 3 Stage (Color choices)

Model#	Base (D)	Base (W)	Height	Color	Weight	Cube	Price
MMLEGAHEL24S3	22"	47-72"	23 1/2" - 49"	Silver	112	1	Standard
MMLEGAHEL24B3	22"	47-72"	23 1/2" - 49"	Black	112	1	No Upcharge
MMLEGAHEL24W3	22"	47-72"	23 1/2" - 49"	White	112	1	No Upcharge

Bases ship unassembled. For black or white adj base must specify model# and color on order.

### NOTES:

- For freestanding return options, see pages 26–28.
- Custom sizes available, email our Design Department.

# maverick series

## Storage Lockers



### Storage Locker Specifications

- ¾" Thick material.
- Standard H10B Black. Choice of handles H3S – H10 & H14. Upgrade to H11 \$94 each.
- Face Lock or Electronic Keypad Lock. (Face lock numbers are randomly assigned for each door)
- 20 TFM standard colors.
- Mix & match Door Fronts with any of our 20 TFM Color Options.
- Mix & match Door Fronts color with any of our HPL Bright Colors, upgrade charges apply.
- Lead Time 20 Days **20**

### Color Specifications

- Top select color. Top edgeband is color matched to top color.
- Base select color. Edgeband is color matched to base color.
- Door Front select color, edgeband is match to base color, unless otherwise specified.

### HPL Bright Color Upgrade Charges

- Door Front select bright color, PVC edgeband is match to base color, unless otherwise specified.
- Door edgeband PVC color must be specified, select one color. See TFM color options chart.
- Upgrade 41" H Locker Door Front, add model# MCSLUDR41 \$306 List (Includes all doors).
- Upgrade 72" H Locker Door Front, add model# MCSLUDR72 \$434 List (Includes all doors).

# maverick series

## Configurations

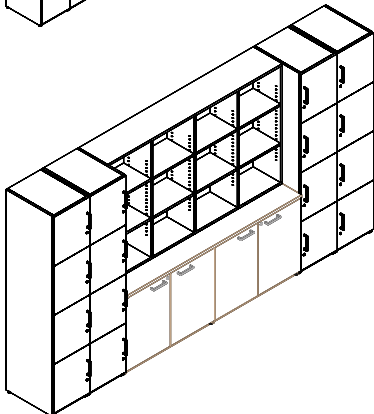
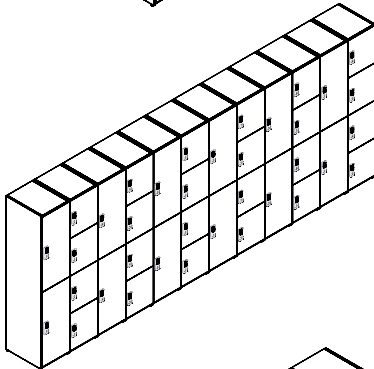
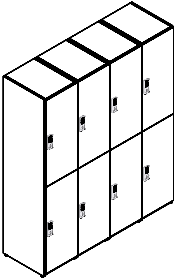
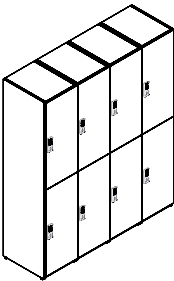
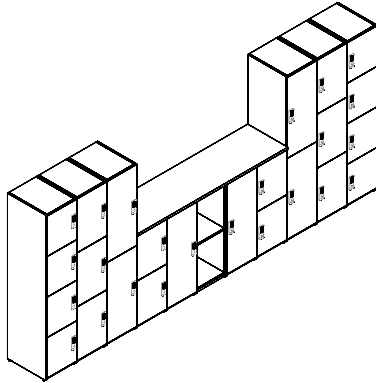

MCSL1				
Qty	Model #	Description	List Price	Extended Price
1	MCCUB201541 2	Custom Cubby 2 Openings 20Dx15Wx41H	\$983	\$983
1	MCSL201541 1LZ	Locker Single Door Left, Digital Lock, 1 Dual Hook 20Dx15Wx41H	\$1,414	\$1,414
1	MCSL201541 1RZ	Locker Single Door Right, Digital Lock, 1 Dual Hook 20Dx15Wx41H	\$1,414	\$1,414
1	MCSL201541 2LZ	Locker 2 Doors Left, Digital Locks 20Dx15Wx41H	\$1,950	\$1,950
1	MCSL201541 2RZ	Locker 2 Doors Right, Digital Locks 20Dx15Wx41H	\$1,950	\$1,950
1	MCSL201572 2LZ	Locker 2 Doors Left, Digital Locks, 2 Dual Hook 20Dx15Wx72H	\$2,262	\$2,262
1	MCSL201572 2RZ	Locker 2 Doors Right, Digital Locks, 2 Dual Hook 20Dx15Wx72H	\$2,262	\$2,262
1	MCSL201572 3LZ	Locker 3 Doors Left, Digital Locks 20Dx15Wx72H	\$2,777	\$2,777
1	MCSL201572 3RZ	Locker 3 Doors Right, Digital Locks 20Dx15Wx72H	\$2,777	\$2,777
1	MCSL201572 4LZ	Locker 4 Doors Left, Digital Locks 20Dx15Wx72H	\$3,338	\$3,338
1	MCSL201572 4RZ	Locker 4 Doors Right, Digital Locks 20Dx15Wx72H	\$3,338	\$3,338
1	MCSLTOP2075	Common Top For 41"H Locker	\$317	\$317
<b>Total</b>			<b>\$24,782</b>	

MCSL2				
Qty	Model #	Description	List Price	Extended Price
4	MCSL201572 2RZ	Locker 2 Doors Right, Digital Locks, 2 Dual Hooks 20Dx15Wx72H	\$2,262	\$9,048
<b>Total</b>			<b>\$9,048</b>	

MCSL2-2				
Qty	Model #	Description	List Price	Extended Price
4	MCSL201541 1RZ	Locker Single Door Right, Digital Lock, 1 Dual Hook 20Dx15Wx41H	\$1,414	\$5,656
4	MCSLUDR41	HPL Bright Color Upgrade for Door Fronts	\$306	\$1,224
1	MCSLPB2060	Planter Box 20Dx60Wx6H for 41"H Locker (Field Install)	\$764	\$764
<b>Total</b>			<b>\$7,644</b>	

MCSL3				
Qty	Model #	Description	List Price	Extended Price
2	MCSL201572 2RZ	Locker 2 Doors Right, Digital Locks, 2 Dual Hook 20Dx15Wx72H	\$2,262	\$4,524
4	MCSL201572 2RZ	Locker 2 Doors Right, Digital Locks, 2 Dual Hook 20Dx15Wx72H	\$2,262	\$9,048
4	MCSLUDR72	HPL Bright Color Upgrade for Door Fronts	\$434	\$1,736
2	MCSL201572 4RZ	Locker 4 Doors Right, Digital Locks 20Dx15Wx72H	\$3,338	\$6,676
4	MCSL201572 4RZ	Locker 4 Doors Right, Digital Locks 20Dx15Wx72H	\$3,338	\$13,352
4	MCSLUDR72	HPL Bright Color Upgrade for Door Fronts	\$434	\$1,736
<b>Total</b>			<b>\$37,072</b>	

MCSL4				
Qty	Model #	Description	List Price	Extended Price
1	MCC2072 1FP	Storage Credenza, 4 Full Hinged Doors 20Dx72Wx29H	\$2,953	\$2,953
1	MCMS127242	Custom Sorter 3 Dividers, 8 Adj. Shelves 12Dx72Wx42 <sup>19</sup> / <sub>16</sub> H	\$2,314	\$2,314
2	MCSL201572 4L	Locker 4 Doors Left, H10B Handles/Face Locks 20Dx15Wx72H	\$2,335	\$4,670
2	MCSL201572 4R	Locker 4 Doors Right, Face Locks 20Dx15Wx72H	\$2,335	\$4,670
<b>Total</b>			<b>\$14,607</b>	

Configurations must be ordered as shown.

# maverick series

## Configurations

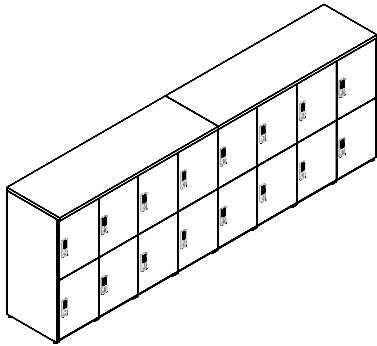

MCSL4-1				
Qty	Model #	Description	List Price	Extended Price
8	MCSL201541 2RZ	Locker 2 Doors Right, Digital Locks 20Dx15Wx41H	\$1,950	\$15,600
8	MCSLUDR41	HPL Bright Color Upgrade for Door Fronts	\$306	\$2,448
2	MCSLTOP2060	Common Top 20Dx60Wx1H for 41"H Locker	\$274	\$548
<b>Total</b>			<b>\$18,596</b>	

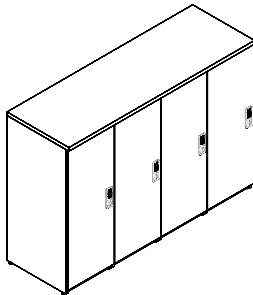

MCSL6				
Qty	Model #	Description	List Price	Extended Price
4	MCSL201541 1LZ	Locker Single Door Left, Digital Lock, 1 Dual Hook 20Dx15Wx41H	\$1,414	\$5,656
1	MCSLTOP2060	Common Top 20Dx60Wx1H for 41"H Locker	\$274	\$274
<b>Total</b>			<b>\$5,930</b>	

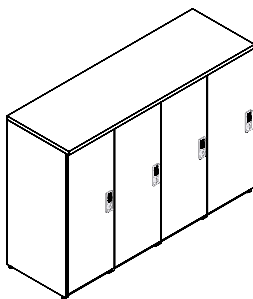

MCSL6-2				
Qty	Model #	Description	List Price	Extended Price
4	MCSL201541 1LZ	Locker Single Door Left, Digital Lock, 1 Dual Hook 20Dx15Wx41H	\$1,414	\$5,656
4	MCSLUDR41	HPL Bright Color Upgrade for Door Fronts	\$306	\$1,224
1	MCSLTOP2060	Common Top 20Dx60Wx1H for 41"H Locker	\$274	\$274
<b>Total</b>			<b>\$7,154</b>	

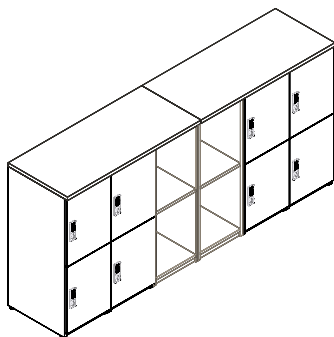

MCSL7				
Qty	Model #	Description	List Price	Extended Price
2	MCCUB201541 2	Custom Cubby, 2 Openings 20Dx15Wx41H	\$983	\$1,966
4	MCSL201541 2RZ	Locker 2 Doors Right, Digital Locks 20Dx15Wx41H	\$1,950	\$7,800
1	MCSLTOP2090	Common Top 20Dx90Wx1H for 41"H Locker	\$359	\$359
<b>Total</b>			<b>\$10,125</b>	

Configurations must be ordered as shown.



# maverick series

## Lockers

(with face lock)

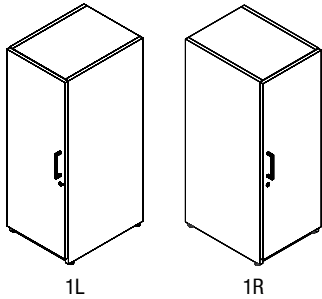

### Locker Single Door, Left (H10B handles, face lock, dual coat hook)

Model#	Depth	Width	Height	Price
MCSL201541 1L	20"	15"	41"	\$1,160

### Locker Single Door, Right (H10B handles, face lock, dual coat hook)

Model#	Depth	Width	Height	Price
MCSL201541 1R	20"	15"	41"	\$1,160

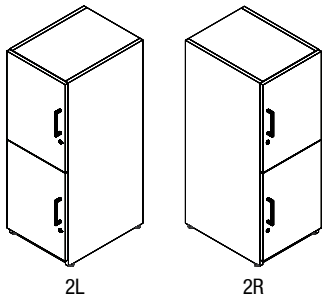

### Locker Two Doors, Left (H10B handles, face locks)

Model#	Depth	Width	Height	Price
MCSL201541 2L	20"	15"	41"	\$1,446

### Locker Two Doors, Right (H10B handles, face locks)

Model#	Depth	Width	Height	Price
MCSL201541 2R	20"	15"	41"	\$1,446

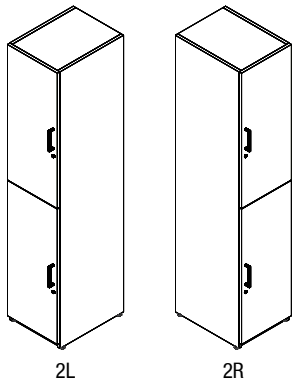

### Locker Two Doors, Left (H10B handles, face locks, 2 dual coat hooks)

Model#	Depth	Width	Height	Price
MCSL201572 2L	20"	15"	72"	\$1,758

### Locker Two Doors, Right (H10B handles, face locks, 2 dual coat hooks)

Model#	Depth	Width	Height	Price
MCSL201572 2R	20"	15"	72"	\$1,758

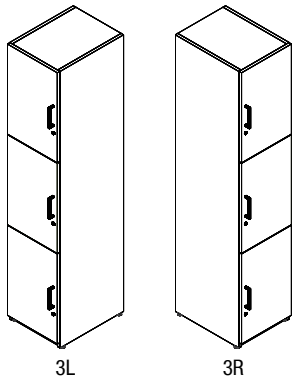

### Locker Three Doors, Left (H10B handles, face locks)

Model#	Depth	Width	Height	Price
MCSL201572 3L	20"	15"	72"	\$2,023

### Locker Three Doors, Right (H10B handles, face locks)

Model#	Depth	Width	Height	Price
MCSL201572 3R	20"	15"	72"	\$2,023

# maverick series

## Lockers

(with face lock)

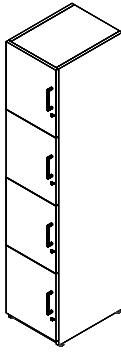

4L

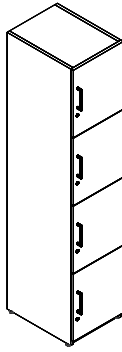

4R

### Locker Four Doors, Left (H10B handles, face locks)

Model#	Depth	Width	Height	Price
MCSL201572 4L	20"	15"	72"	\$2,335

### Locker Four Doors, Right (H10B handles, face locks)

Model#	Depth	Width	Height	Price
MCSL201572 4R	20"	15"	72"	\$2,335

## Lockers

(with digital lock)

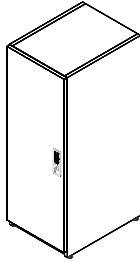

1LZ

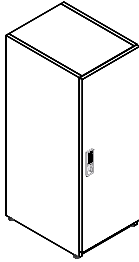

1RZ

### Locker Single Doors, Left (Digital lock, dual coat hook)

Model#	Depth	Width	Height	Price
MCSL201541 1LZ	20"	15"	41"	\$1,414

### Locker Single Doors, Right (Digital lock, dual coat hook)

Model#	Depth	Width	Height	Price
MCSL201541 1RZ	20"	15"	41"	\$1,414

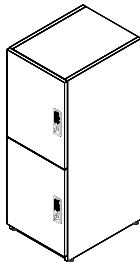

2LZ

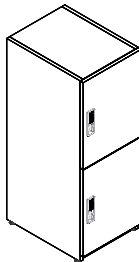

2RZ

### Locker Two Doors, Left (Digital locks)

Model#	Depth	Width	Height	Price
MCSL201541 2LZ	20"	15"	41"	\$1,950

### Locker Two Doors, Right (Digital locks)

Model#	Depth	Width	Height	Price
MCSL201541 2RZ	20"	15"	41"	\$1,950

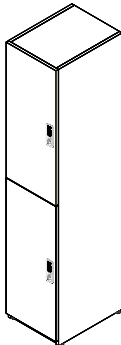

2LZ

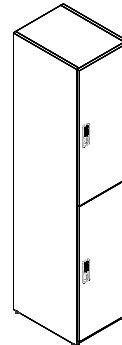

2RZ

### Locker Two Doors, Left (Digital locks, 2 dual coat hooks)

Model#	Depth	Width	Height	Price
MCSL201572 2LZ	20"	15"	72"	\$2,262

### Locker Two Doors, Right (Digital locks, 2 dual coat hooks)

Model#	Depth	Width	Height	Price
MCSL201572 2RZ	20"	15"	72"	\$2,262

# maverick series

## Lockers

(with digital lock)

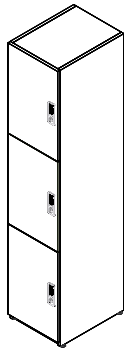

3LZ

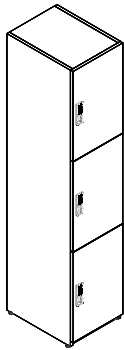

3RZ

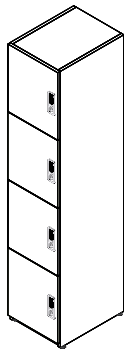

4LZ

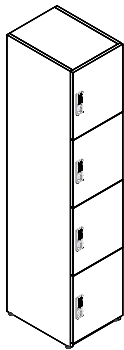

4RZ

### Locker Three Doors, Left (Digital locks)

Model#	Depth	Width	Height	Price
MCSL201572 3LZ	20"	15"	72"	\$2,777

### Locker Three Doors, Right (Digital locks)

Model#	Depth	Width	Height	Price
MCSL201572 3RZ	20"	15"	72"	\$2,777

### Locker Four Doors, Left (Digital locks)

Model#	Depth	Width	Height	Price
MCSL201572 4LZ	20"	15"	72"	\$3,338

### Locker Four Doors, Right (Digital locks)

Model#	Depth	Width	Height	Price
MCSL201572 4RZ	20"	15"	72"	\$3,338

## Common Tops

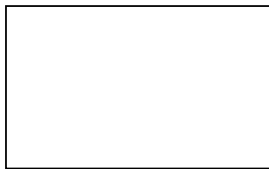

### Top For Locker (1 Piece top)

Model#	Depth	Width	Height	Fits Locker	Price
MCSLTOP2015	20"	15"	1"	(1) 15"W	\$146
MCSLTOP2030	20"	30"	1"	(2) 15"W	\$188
MCSLTOP2045	20"	45"	1"	(3) 15"W	\$231
MCSLTOP2060	20"	60"	1"	(4) 15"W	\$274
MCSLTOP2075	20"	75"	1"	(5) 15"W	\$317
MCSLTOP2090	20"	90"	1"	(6) 15"W	\$359

Recommended 1 piece top for 41"H lockers, field install ships with screws.

## Planter Box

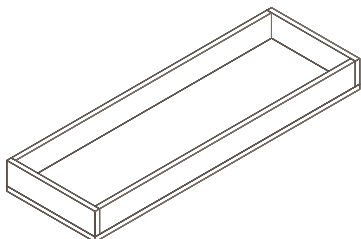

### Planter Box for Locker

Model#	Depth	Width	Height	Fits Planter	Price
MCSLPB2030	20"	30"	6"	(2) 15"W	\$629
MCSLPB2045	20"	45"	6"	(3) 15"W	\$697
MCSLPB2060	20"	60"	6"	(4) 15"W	\$764

Field install, ships with wood screws. Place on 41"H lockers, for the use of artificial plants only.

# maverick series

## Accessories & Upgrades



Coat Hook		
Model#	Description	Price
MCSLHOOK1	Single Coat Hook	\$36
MCSLHOOK2	Dual Coat Hook	\$43



Master Key		
Model#	Description	Price
MMLFZ	Master Key unlocks/controls digital lock Zephyr 2310	\$88
MM-MASTER KEY	Unlocks Maverick locks	\$88

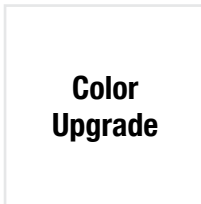

HPL Bright Color Upgrade		
Model#	Description	Price
MCSLUDR41	Upgrade 41"H Locker Door Front	\$306
MCSLUDR72	Upgrade 72"H Locker Door Front	\$434

For door fronts select bright color, PVC edgeband is match to base color, unless otherwise specified. Door edgeband PVC color must be specified, select one color. See TFM color options chart. Upcharge includes all doors per locker.

## HPL Bright Colors

(For Locker Door Fronts)

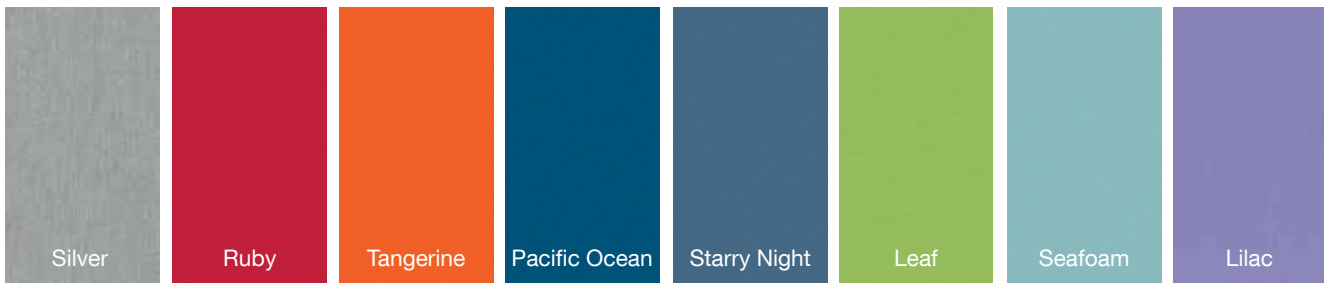

Upgrade storage locker door fronts with one of our HPL bright colors and select one of our 20 standard TFM colors options for door PVC edgeband. Charges apply. Laminate finishes are approximations. Colors may vary between factories. TFM & HPL laminate finishes will vary.

# handle options



Crescent Black  
(MMH3B)



Crescent Silver  
(MMH3S)



Elliptical Black  
(MMH5B)



Elliptical Silver  
(MMH5S)



Crescent Textured Nickel  
(MMH6)



Flared Nickel  
(MMH7)



Bow Handle  
(MMH8)



Curved Handle  
(MMH9)



Bar Handle  
(MMH13)



Bar Handle  
(MMH14)



Bar Square Handle Black  
(MMH10B)



Bar Square Handle Silver  
(MMH10S)



Bar Square Handle Silver  
(MMH11)  
\$94 list each

**Note:** H11 & H14 handles fit only on 41"H lockers & 72"H two door lockers.

## standard features



Bar Square Handle Black  
(MMH10B)  
and Face Lock



Electronic Keypad Digital Lock  
Permanent or shared use,  
4-digit user code & 6-digit user code

# maverick series TFM color options



Maverick Series

## tackboard fabric options

### Anchorage 2335



### Cape Cod 3073



### Tempest 2120



### Metro 3077



### Metallation 5118



### Sprite 2671



### Phrase 9508



Laminate finishes & fabric samples shown are approximations. Colors may vary between factories. TFM & HPL laminate finishes will vary.

For sample requests, email Maverick West: [orderentry@maverickdesk.com](mailto:orderentry@maverickdesk.com). Maverick East: [mveorders@maverickdesk.com](mailto:mveorders@maverickdesk.com)

For actual fabric samples, go to: [guilfordofmaine.com/swatches](http://guilfordofmaine.com/swatches)

**Note:** Renderings & line drawings shown are a resemblance to finished product. Product designs may vary. Discounts are different between factories.

Two standard colors may be specified at no charge. For three color combinations, email for quote.