

gravity series



Gravity, where the forces of design and function are drawn together. Create the perfect environment in a corporate, home or an open plan office.

Standard Features

MMH10S Silver Handles, Grommets and Locks are standard where shown on items/line drawings.



Bar Square Handle Silver
(MMH10S)



Power Grommet Silver
(GPRGR3S)



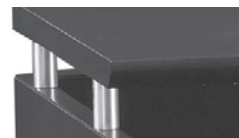

Silver Grommet
(MMGR234S)



Edge Detail/Silver Spacers

gravity series

Product Specifications

- Floating appearance 1" thick tops, 2mm thermally-fused PVC edge banding.
- Rectangular top and end panels or curved top and curved end panels style.
- Desks and Bridges ½ TFM Modesty Panel.
- Silver power grommets on returns, bridges, and low credenzas tops.
- Standard H10S silver. Choice of handles H3S – H10B, H13 & H14.
- Standard silver face locks on all pedestals and freestanding storage.
- Standard silver spacers, silver tapered feet. Silver mounting clips on screens/modesty.
- 20 standard color options.
- Lead time  15 days. Bright color options  20 days.

STANDARD FEATURES AND OPTIONS

Note: Options must be specified on order.

- MMH10S silver handles, silver grommets and locks are standard where shown and specified on items/line drawings.
- Grommets, upgrade color from silver to black, no charge.
- Grommet color silver or black will match tapered feet except white feet, which will take silver grommets.
- Spacers and tapered feet available in black and white at no charge. Spacers will match feet color.
- Lock numbers (#101-115) are randomly assigned, specify key-alike at no charge.
- Mounting clips for privacy screens/modesty available in black and white at no charge.
- Full modesty panel upgrade available on desks, credenzas & bridges.

STANDARD HANDLE OPTIONS



Crescent Black
(MMH3B)



Crescent Silver
(MMH3S)



Elliptical Black
(MMH5B)



Elliptical Silver
(MMH5S)



Crescent Textured Nickel
(MMH6)



Flared Nickel
(MMH7)



Bow Handle
(MMH8)



Curved Handle
(MMH9)



Bar Handle
(MMH13)



Bar Handle
(MMH14)



Bar Square Handle Black
(MMH10B)



Bar Square Handle Silver
(MMH10S)

Note: H10S silver handles and silver grommets will be provided, unless otherwise specified.

Note: Line Drawings shown are a resemblance to finished product. Product designs may vary. Discounts are different between factories.

gravity series

Statement of Line

DESKS

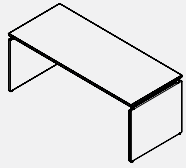

GRN_ _ _ _

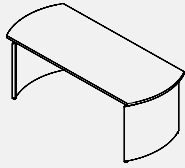

GRNC_ _ _ _

CREDENZAS

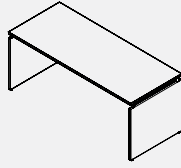

GRN_ _ _ _

WORKSURFACES

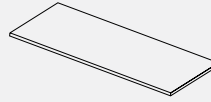

GRRW_ _ _ _

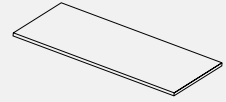

GRRRW_ _ _ _

BRIDGES

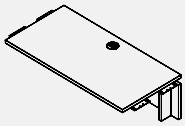

GRBR_ _ _ _

RETURNS

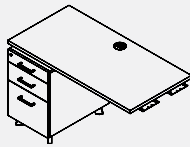

GRRE_ _ _ _L

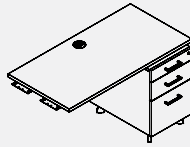

GRRE_ _ _ _R

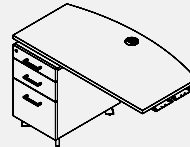

GRRT_ _ _ _L

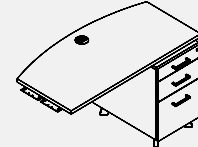

GRRT_ _ _ _R

SUPPORTING PEDESTALS



GRPEDE_ _

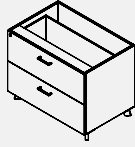

GRPEDLF_ _ _

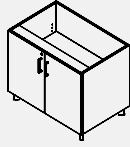

GRPEDHDC_ _ _

SUPPORTING LOW CREDENZAS

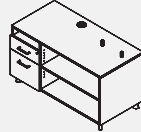

GRSSBF_ _ _ _L

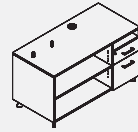

GRSSBF_ _ _ _R

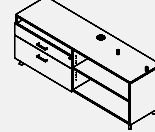

GRSSBL_ _ _ _L

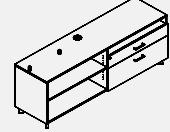

GRSSBL_ _ _ _R

FREESTANDING PEDESTALS



GRPEDEM_ _



GRPEDEX_ _

FREESTANDING BOOKCASES

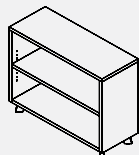

GRBC_ _

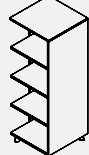

GRBCC_ _ _ _L



GRBCC_ _ _ _R

FREESTANDING STORAGE CREDENZAS

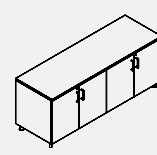

GRC_ _ _ _1FP

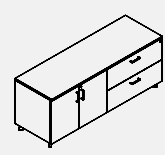

GRC_ _ _ _9FP

METAL LEGS

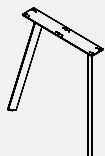

GROTL_ _



GRSPL28

STABILIZER BAR



GRSB_ _

FROSTED & CLEAR PRIVACY SCREENS/MODESTY

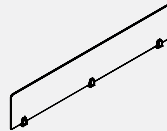

GRPSF_ _ _12
GRPSC_ _ _12

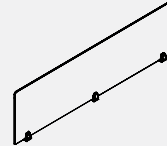

GRPSF_ _ _18
GRPSC_ _ _18

gravity series

Statement of Line

TFM & HPL PRIVACY SCREENS/MODESTY

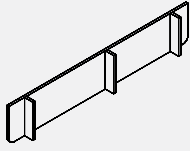

GRMPW__12
GRMPHP__12

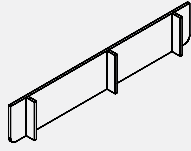

GRMPW__18
GRMPHP__18

TACKABLE FABRIC/MARKERBOARD PRIVACY SCREENS

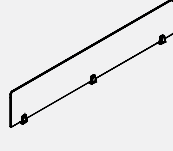

GRPSTB__12
GRPSMB__12

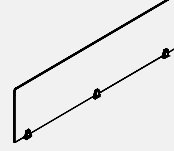

GRPSTB__18
GRPSMB__18

FREESTANDING STORAGE CABINETS / PERSONAL BOOKCASE CABINETS

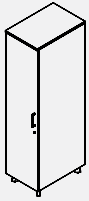

GRSTS__L

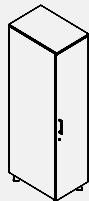

GRSTS__R

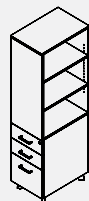

GRBCPS__L

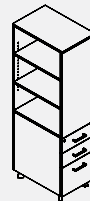

GRBCPS__R

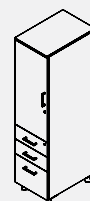

GRBCV__L

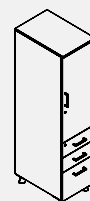

GRBCV__R

OVERHEAD STORAGE CABINETS

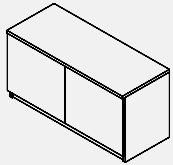

GRCFOHD__

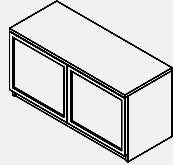

GRCFOHG36

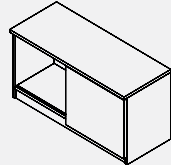

GRCFOHS__

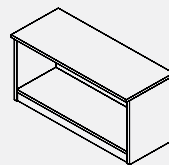

GRCFOHO__

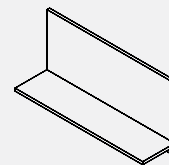

GRCFOS__

HUTCHES

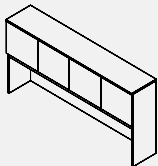

GRH__WD

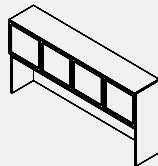

GRH72WG

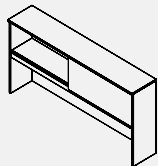

GRH__SD

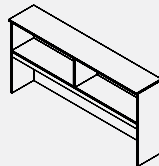

GRH__ND

BOOKCASE HUTCH

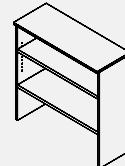

GRBCH36

TACKBOARD



MMTKBD__

RECEPTIONS

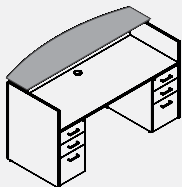

GRCAD3072

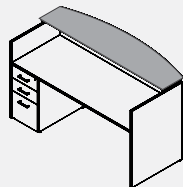

GRCAS3072L

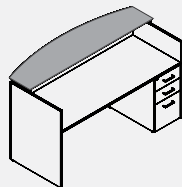

GRCAS3072R

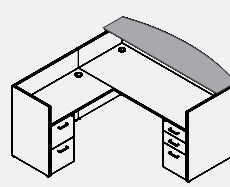

GRCAX3072L

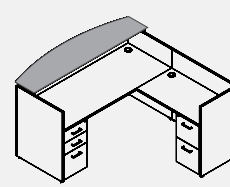

GRCAX3072R

gravity series

Configurations

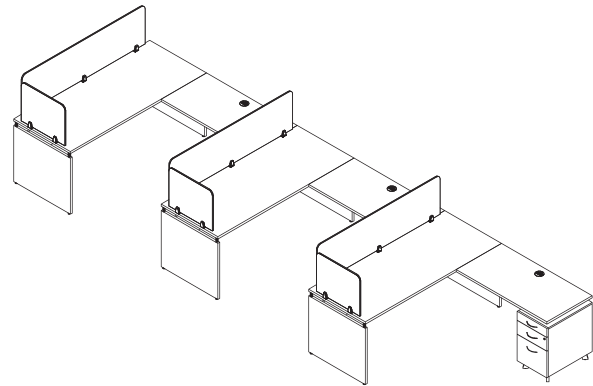
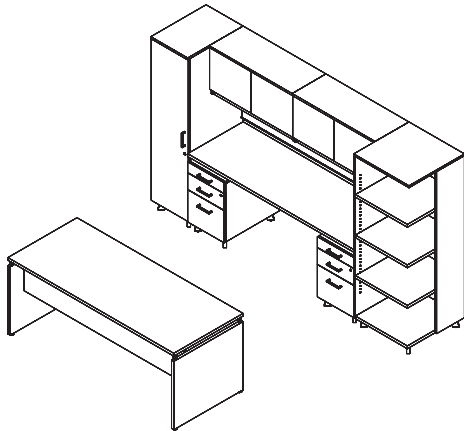

GR1				
Qty	Model #	Description	List Price	Extended Price
1	GRN3072	Desk Shell Rectangular Top ½ Mod Panel (30"Dx72"Wx29"H) (1-Stabilizer Bar GRSB72)	\$1,350	\$1,350
1	GRUMOD__	Upgrade Modesty to HPL Metallic or Bright color (optional)	\$171	\$171
1	GRRW2472	Rectangular Top Square Corners (24"Dx72W"x1")	\$415	\$415
2	GRSB66	Stabilizer Bar 50"W (For GRRW2472)	\$167	\$334
2	GRPEDE24	Support Pedestal P/B/F Top w/ Spacers (24"Dx16"Wx28"H) (H10S Silver Handles)	\$1,484	\$2,968
1	GRSTS2465L	Single Storage Cabinet Left Door (24"Dx16"Wx65"H) (H10S Silver Handles)	\$2,276	\$2,276
1	GRBCC2465R	Corner Bookcase Right (24"Dx24"Wx65"H)	\$1,761	\$1,761
2	GRCFOHD36	Wallmount Cabinet 2-Hinged Doors w/ Fascia (14 ¾"Dx36"Wx18 ½"H)	\$1,138	\$2,276
1	MMTKBD72	Tackboard (1"Dx72"Wx14 ¾"H) (Wallmount)	\$931	\$931
Total			\$12,482	

GR2R				
Qty	Model #	Description	List Price	Extended Price
3	GRN3072	Desk Shell Rectangular Top ½ Mod Panel (30Dx72Wx29H) (1-Stabilizer Bar GRSB72 ea.)	\$1,350	\$4,050
3	GRRE2448R	Return Rectangular Top No Modesty, Right P/B/F (24"Dx48"Wx29"H) (H3S Silver Handles)	\$2,369	\$7,107
3	GRPSTB7218	Tackable Fabric Privacy Screen (½"Dx65"Wx18 ⅝"H)	\$775	\$2,325
3	GRPSTB3018	Tackable Fabric Privacy Screen (½"Dx23"Wx18 ⅝"H)	\$427	\$1,281
Total			\$14,763	

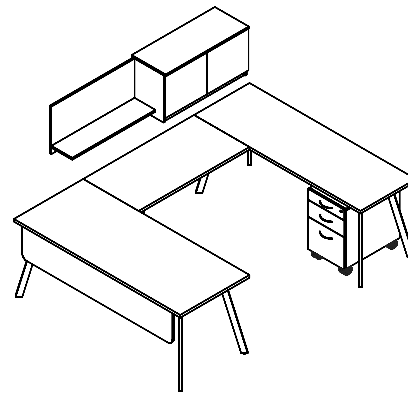

GR3R				
Qty	Model #	Description	List Price	Extended Price
1	GRRW3072	Rectangular Top Square Corners 30"Dx72"Wx1"	\$460	\$460
2	GROTL30	Tapered Metal Leg 30"Dx2"Wx28"H	\$712	\$1,424
2	GRSB72	Stabilizer Bar 56W (For GRRW3072)	\$181	\$362
1	GRMPW7212	TFM Privacy Modesty Panel ¾"Dx65"Wx12 ⅝"H	\$296	\$296
1	GRRRW2448	Rectangular Bridge Top 24"Dx48"Wx1"	\$359	\$359
1	GRSPL28	Single Post Metal Leg 2"Dx1"Wx28"H Center Support (For GRRRW2448)	\$306	\$306
1	GRRW2472	Rectangular Top Square Corners 24"Dx72"Wx1"	\$415	\$415
2	GRSB72	Stabilizer Bar 56W (For GRRW2472)	\$181	\$362
2	GROTL24	Tapered Metal Leg 24"Dx2"Wx28"H	\$676	\$1,352
2	GRGANG24	Connecting Hardware U-Shape/Bridge Top	\$54	\$108
1	GRPEDEX24	Mobile Pedestal P/B/F with Casters 24"Dx16"Wx26 ⅞"H (H3S Silver Handles)	\$1,246	\$1,246
1	GRCFOHD36	Wallmount Cabinet 2-Hinged Doors w/ Fascia 14 ¾"Dx36"Wx18 ½"H	\$1,138	\$1,138
1	GRCFOS36	Wallmount Shelf w/ Back Panel 11"Dx36"Wx17 ¾"H (shelf 10D)	\$404	\$404
Total			\$8,232	

Configurations must be ordered as shown.

gravity series

Configurations

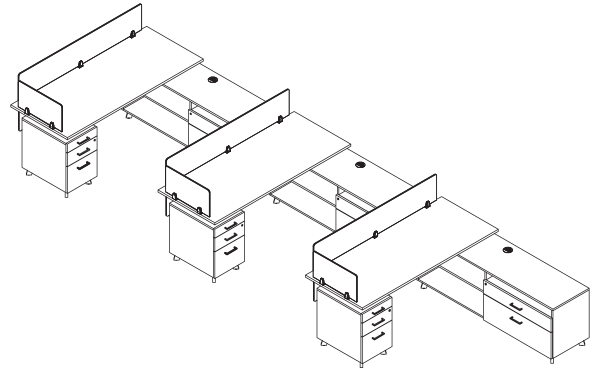
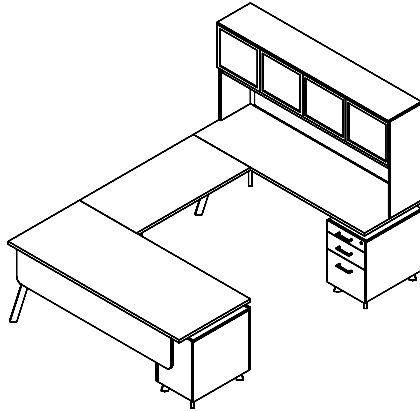

GR4R

Qty	Model #	Description	List Price	Extended Price
1	GRRW3072	Rectangular Top Square Corners 30"Dx72"Wx1"	\$460	\$460
1	GROTL30	Tapered Metal Leg 30"Dx2"Wx28"H	\$712	\$712
1	GRPEDE24	Support Pedestal P/B/F Top with Spacers 24"Dx16"Wx28"H (H10S Silver Handles)	\$1,484	\$1,484
2	GRSB72	Stabilizer Bar 56"W (For GRRW3072)	\$181	\$362
1	GRMPHP7212	HPL Modesty Panel ¾"Dx65"Wx12 ⅝"H	\$458	\$458
1	GRRRW2448	Rectangular Bridge Top 24"Dx48"Wx1"	\$359	\$359
1	GRSPL28	Single Post Metal Leg 2"Dx1"Wx28"H Center Support (For GRRRW2448)	\$306	\$306
1	GRRW2472	Rectangular Top Square Corners 24"Dx72"Wx1"	\$415	\$415
1	GROTL24	Tapered Metal Leg 24"Dx2"Wx28"H	\$676	\$676
1	GRPEDE24	Support Pedestal P/B/F Top with Spacers 24"Dx16"Wx28"H (H10S Silver Handles)	\$1,484	\$1,484
2	GRSB72	Stabilizer Bar 56"W (For GRRW2472)	\$181	\$362
2	GRGANG24	Connecting Hardware U-shape/Bridge Top	\$54	\$108
1	GRH72WG	Hutch 4-Frosted Glass Doors with Fascia 4"Dx72"Wx36"H	\$2,336	\$2,336
1	MMTKBD66	Tackboard 1"Dx66"Wx14 ¾"H (For GRH72WG)	\$824	\$824
Total			\$10,346	

GR5R

Qty	Model #	Description	List Price	Extended Price
3	GRRW3072	Rectangular Top Square Corners 30Dx72Wx1"	\$460	\$1,380
3	GRPEDE24	Support Pedestal P/B/F Top with Spacers 24Dx16Wx28H (H10S Silver Handles)	\$1,484	\$4,452
3	GRSSBL2472R	Support Low Credenza Right Box/Lat File/Left Bookcase Top w/ Spacers 24Dx72Wx26 ⅝"H (H10S Silver Handles)	\$3,071	\$9,213
6	GRSB66	Stabilizer Bar 50"W (For GRRW3072 two ea.)	\$167	\$1,002
3	GRPSF7212	Frosted Acrylic Privacy Screen ¾Dx65Wx12 ⅝"H	\$631	\$1,893
3	GRPSF7212	Frosted Acrylic Modesty Panel ¾Dx65Wx12 ⅝"H	\$631	\$1,893
3	GRPSF3012	Frosted Acrylic Privacy Screen ¾Dx23Wx12 ⅝"H	\$259	\$777
Total			\$20,610	

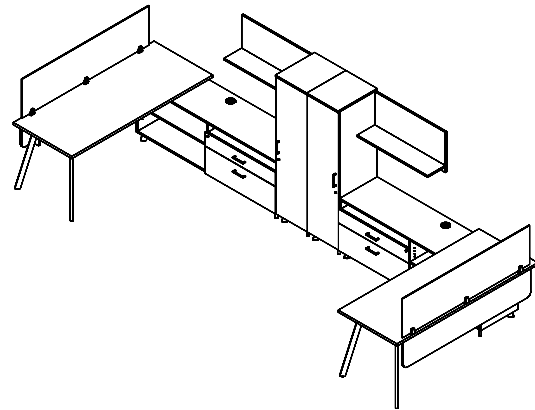

GR6

Qty	Model #	Description	List Price	Extended Price
2	GRRW3072	Rectangular Top Square Corners 30"Dx72"Wx1"	\$460	\$920
2	GROTL30	Tapered Metal Leg 30"Dx2"Wx28"H	\$712	\$1,424
2	GRPSMB7218	Markerboard Privacy Screen ½"Dx65"Wx18 ⅝"H	\$781	\$1,562
2	GRMPHP7212	HPL Modesty Panel ¾"Dx65"Wx12 ⅝"H	\$458	\$916
4	GRSB72	Stabilizer Bar 56"W (For GRRW3072 two ea.)	\$181	\$724
1	GRSSBL2072R	Support Low Credenza Right Box/Lat File/Left Bookcase Top w/ Spacers 20"Dx72"Wx26 ⅝"H (H10S Silver Handles)	\$2,974	\$2,974
1	GRSSBL2072L	Support Low Credenza Left Box/Lat File/Right Bookcase Top w/ Spacers 20"Dx72"Wx26 ⅝"H (H10S Silver Handles)	\$2,974	\$2,974
1	GRSTS2065R	Single Storage Cabinet Right Door 20"Dx16"Wx65"H (H10S Silver Handles)	\$2,155	\$2,155
1	GRSTS2065L	Single Storage Cabinet Left Door 20"Dx16"Wx65"H (H10S Silver Handles)	\$2,155	\$2,155
2	GRCFOS36	Wallmount Shelf w/ Back Panel 11"Dx36"Wx17 ¾"H (Shelf 10D)	\$404	\$808
Total			\$16,612	

Configurations must be ordered as shown.

gravity series

Configurations

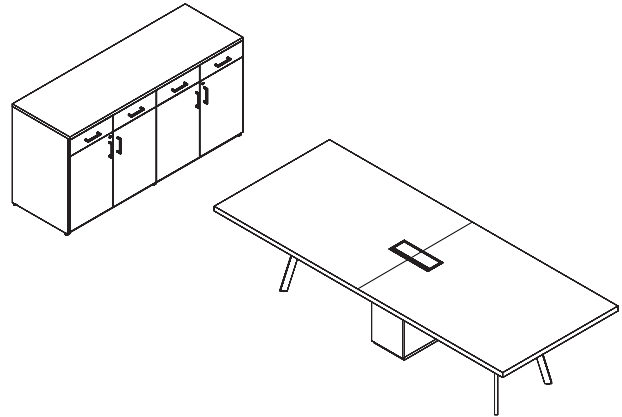
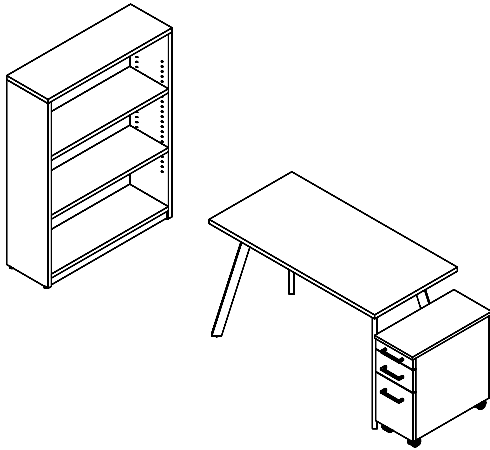

GR7				
Qty	Model #	Description	List Price	Extended Price
1	GRRW2448	Rectangular Top Square Corners 24"Dx48"Wx1"	\$359	\$359
2	GROTL24	Tapered Metal Leg 24"Dx2"Wx28"H	\$676	\$1,352
1	MCPEDSX	Slim Mobile Pedestal P/B/F 23"Dx10 1/2"Wx24"H (H10S Silver Handles)	\$1,265	\$1,265
1	MCBC3648	Bookcase 2-Adj Shelves 12"Dx36"Wx48"H	\$944	\$944
Total			\$3,920	

GR8				
Qty	Model #	Description	List Price	Extended Price
1	APRE48120	Rectangular Conf. Table 2-piece Top, Sq. Corners 48Dx120Wx1 3/4"	\$1,902	\$1,902
2	GROTL24	Tapered Metal Leg 24"Dx2"Wx28"H	\$676	\$1,352
1	MMLEGMP1324WD	Sq. Panel Base w/ End Access Door & Plinth Base 13"Dx24"Wx28"H	\$1,041	\$1,041
1	MMCUT3	Base Notch Out for Power Mgmt. Unit (MMRPMU16S)	\$234	\$234
2	APWMT	Wire Management Trough Box	\$526	\$1,052
1	MMRPMU16S	Metal Reef Power Management Unit, Silver	\$2,770	\$2,770
1	MCHDBC2072	Buffet Credenza 4 Box Drawers/4 Hinged Doors 20"Dx72"Wx36"H (H10S Silver Handles)	\$3,996	\$3,996
Total			\$12,347	

NOTE: Conference Table Top requires all bases as shown in this line drawing.

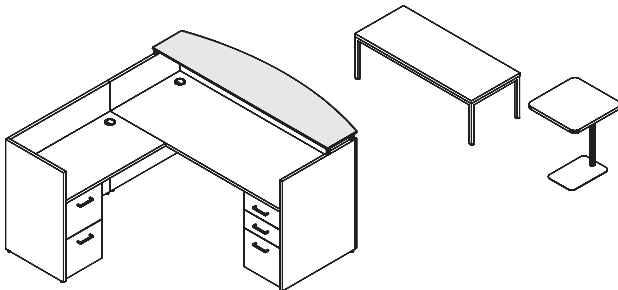

GR9L				
Qty	Model #	Description	List Price	Extended Price
1	GRCAX3072L	Reception L-Unit Left Return FF/Desk BBF, Fan Countertop w/ Clear Glass (H3S Silver Handles) 30/36"Dx72"W - 24"Dx42"Wx42"H	\$6,675	\$6,675
1	MMCT204816W	Coffee Table with Square Metal 4 Legs White 20"Dx48"Wx16"H	\$811	\$811
1	MMSQ18	Square Laptop w/ Radius Corners, 18"Dx18"Wx1"	\$248	\$248
1	MMLEGLTS15	Laptop Square Metal Base 15 1/2"Dx10 1/2"Wx24"H	\$550	\$550
Total			\$8,284	

Configurations must be ordered as shown.

gravity series

Desks

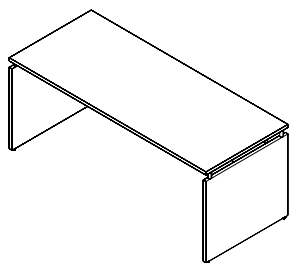

Desk Shell Rectangular Top, 1/2 TFM Modesty (Silver spacers, 1 stabilizer bar, 1/2 modesty inset 6")

Model#	Depth	Width	Height	Stabilizer Bar	Weight	Cube	Price
GRN3060	30"	60"	29"	GRSB60	114	31	\$1,292
GRN3066	30"	66"	29"	GRSB66	120	34	\$1,322
GRN3072	30"	72"	29"	GRSB72	127	37	\$1,350

Upgrade spacers color at no charge: for Black add GRUSB • for White add GRUSW.
Upgrade modesty to HPL metallic or bright color: add GRUMOD__ \$171 list, see page 195.
 Stabilizer bar ships installed. Specify if standalone. For full modesty upgrade, see page 195.
 Bright colors lead time 20 days.

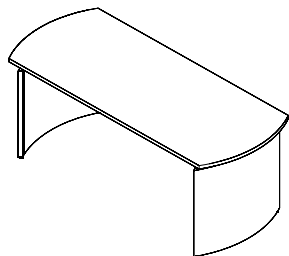

Desk Shell Curved Top, 1/2 TFM Modesty (Silver spacers, 1 stabilizer bar, 1/2 modesty inset 8 1/2")

Model#	Depth	Width	Height	Stabilizer Bar	Weight	Cube	Price
GRNC3066	30"	66"	29"	GRSB66	160	40	\$2,684
GRNC3072	30"	72"	29"	GRSB72	166	44	\$2,714

Upgrade spacers color at no charge: for Black add GRUSB • for White add GRUSW.
Upgrade modesty to HPL metallic or bright color: add GRUMOD__ \$171 list, see page 195.
 Stabilizer bar ships installed. Specify if standalone. For full modesty upgrade, see page 195.
 Bright colors lead time 20 days.
 Note: Curved end panels are made in HPL. For standard availability of HPL, see color options page 196.

Credenzas

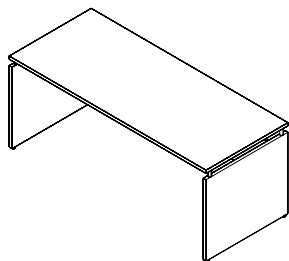

Credenza Shell Rectangular Top, 1/2 TFM Modesty (Silver spacers, 1 stabilizer bar, flush 1/2 modesty)

Model#	Depth	Width	Height	Stabilizer Bar	Weight	Cube	Price
GRN2066	20"	66"	29"	GRSB66	86	23	\$1,179
GRN2072	20"	72"	29"	GRSB72	91	25	\$1,201
GRN2466	24"	66"	29"	GRSB66	100	27	\$1,236
GRN2472	24"	72"	29"	GRSB72	105	29	\$1,260

Upgrade spacers color at no charge: for Black add GRUSB • for White add GRUSW.
Upgrade modesty to HPL metallic or bright color: add GRUMOD__ \$171 list, see page 195.
 Stabilizer bar ships installed. Specify if standalone. For full modesty upgrade, see page 195.
 Bright colors lead time 20 days.

Bridges

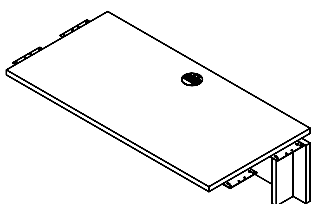

Bridge Rectangular Top, 1/2 TFM Modesty with Dividers (Silver spacers, 1 GRPRGR3S power grommet)

Model#	Depth	Width	Height	Weight	Cube	Price
GRBR2042	20"	42"	29"	86	23	\$1,062
GRBR2048	20"	48"	29"	91	25	\$1,083
GRBR2442	24"	42"	29"	100	27	\$1,078
GRBR2448	24"	48"	29"	105	29	\$1,104

Silver Power Grommet center top. Connecting hardware is included.
Upgrade spacers color at N/C: for Black add GRUSB • for White add GRUSW. For full modesty upgrade, see page 195.
Upgrade modesty to HPL metallic or bright color: add GRUMOD__ \$171 list, see page 195.
 Bright colors lead time 20 days.

Returns

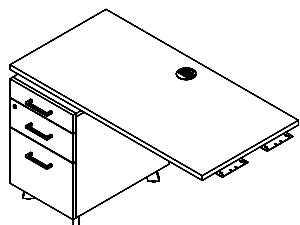

Return Rectangular Top, Left Pencil/Box/File, No Modesty

(Silver spacers & tapered feet, H10S handles, face lock, 1 GRPRGR3S power grommet)

Model#	Depth	Width	Height	Weight	Cube	Price
GRRE2042L	20"	42"	29"	109	5	\$2,292
GRRE2048L	20"	48"	29"	112	5	\$2,314
GRRE2442L	24"	42"	29"	121	6	\$2,345
GRRE2448L	24"	48"	29"	125	6	\$2,369

Silver Power Grommet center top. Connecting hardware is included.
Upgrade spacers & feet color at no charge: for Black add GRUSFB • for White add GRUSFW.
Handle Option: Specify H3B-H10B, H13 & H14 at no charge.

gravity series

Returns

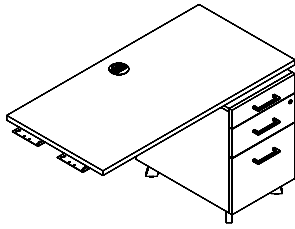

Return Rectangular Top, Right Pencil/Box/File, No Modesty
(Silver spacers & tapered feet, H10S handles, face lock, 1 GRPRGR3S power grommet)

Model#	Depth	Width	Height	Weight	Cube	Price
GRRE2042R	20"	42"	29"	109	5	\$2,292
GRRE2048R	20"	48"	29"	112	5	\$2,314
GRRE2442R	24"	42"	29"	121	6	\$2,345
GRRE2448R	24"	48"	29"	125	6	\$2,369

Silver Power Grommet center top. Connecting hardware is included.
Upgrade spacers & feet color at no charge: for Black add GRUSFB • for White add GRUSFW.
Handle Option: Specify H3B-H10B, H13 & H14 at no charge.

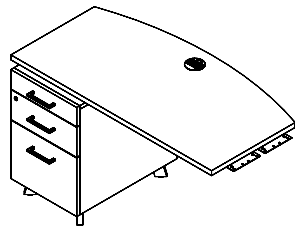

Return Curved Top, Left Pencil/Box/File, No Modesty
(Silver spacers & tapered feet, H10S handles, face lock, 1 GRPRGR3S power grommet)

Model#	Depth	Width	Height	Weight	Cube	Price
GRRT2442L	20/24"	42"	29"	121	6	\$2,274
GRRT2448L	20/24"	48"	29"	125	6	\$2,291

Silver Power Grommet center top. Connecting hardware is included.
Upgrade spacers & feet color at no charge: for Black add GRUSFB • for White add GRUSFW.
Handle Option: Specify H3B-H10B, H13 & H14 at no charge.

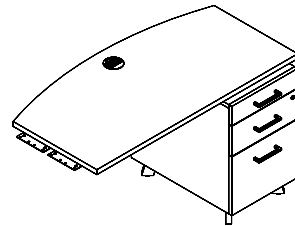

Return Curved Top, Right Pencil/Box/File, No Modesty
(Silver spacers & tapered feet, H10S handles, face lock, 1 GRPRGR3S power grommet)

Model#	Depth	Width	Height	Weight	Cube	Price
GRRT2442R	20/24"	42"	29"	121	6	\$2,274
GRRT2448R	20/24"	48"	29"	125	6	\$2,291

Silver Power Grommet center top. Connecting hardware is included.
Upgrade spacers & feet color at no charge: for Black add GRUSFB • for White add GRUSFW.
Handle Option: Specify H3B-H10B, H13 & H14 at no charge.

Worksurfaces

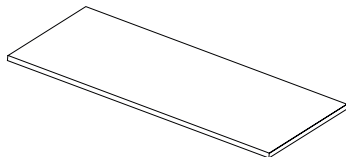

Rectangular Top, Square Corners

Model#	Depth	Width	Height	Weight	Cube	Price
GRRW2448	24"	48"	1"	30	1	\$359
GRRW2066	20"	66"	1"	35	1	\$335
GRRW2072	20"	72"	1"	38	1	\$364
GRRW2466	24"	66"	1"	42	1	\$400
GRRW2472	24"	72"	1"	45	1	\$415
GRRW3060	30"	60"	1"	47	2	\$379
GRRW3066	30"	66"	1"	52	2	\$423
GRRW3072	30"	72"	1"	57	2	\$460

Wood grain colors run horizontal. Connecting Hardware required for U-shapes and L-shapes.
2 Stabilizer Bars are required for tops 60"W, 66"W & 72"W.
Connecting hardware and stabilizer bars not included.

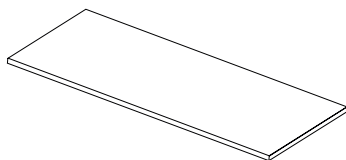

Rectangular Return or Bridge Top, Square Corners

Model#	Depth	Width	Height	Weight	Cube	Price
GRRRW2036	20"	36"	1"	19	1	\$241
GRRRW2042	20"	42"	1"	22	1	\$248
GRRRW2048	20"	48"	1"	25	1	\$262
GRRRW2436	24"	36"	1"	23	1	\$329
GRRRW2442	24"	42"	1"	27	1	\$341
GRRRW2448	24"	48"	1"	30	1	\$359

Tops can be used as return top or bridge top. Wood grain colors run vertical.
All tops being used as bridges required GRSPL28 center support single post metal leg (not included).
Connecting Hardware required for Return top 2 brackets, Bridge top 4 brackets (not included).

gravity series

Supporting Pedestals

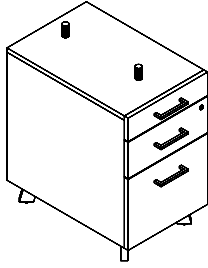

Support Pedestal Pencil/Box/File, Top with Spacers
(Silver spacers & tapered feet, H10S handles, face lock)

Model#	Depth	Width	Height	Weight	Cube	Price
GRPEDI20	20"	16"	28"	86	5	\$1,449
GRPEDI24	24"	16"	28"	93	6	\$1,484

Top is predrilled for 2 spacers, install flush pedestal with top edge.
Upgrade spacers & feet color at no charge: for Black add GRUSFB • for White add GRUSFW.
Handle Option: Specify H3B-H10B, H13 & H14 at no charge.
 Specify left or right install for worksurface.

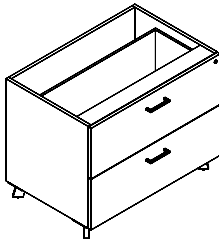

Support Pedestal Lateral File 2 Drawer, No Top (Silver tapered feet, H10S handles, face lock)

Model#	Depth	Width	Height	Weight	Cube	Price
GRPDLF2036	20"	36"	28"	120	11	\$1,949
GRPDLF2436	24"	36"	28"	128	13	\$2,004

Upgrade feet color at no charge: for Black add GRUFB • for White add GRUFW.
Handle Option: Specify H3B-H10B, H13 & H14 at no charge.

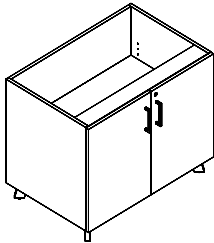

Support Pedestal Hinged Door Cabinet, No Top
(Silver tapered feet, H10S handles, face lock, 1 adjustable shelf ¾")

Model#	Depth	Width	Height	Weight	Cube	Price
GRPEDHDC2036	20"	36"	28"	104	11	\$1,716
GRPEDHDC2436	24"	36"	28"	115	13	\$1,758

Upgrade feet color at no charge: for Black add GRUFB • for White add GRUFW.
Handle Option: Specify H3B-H10B, H13 & H14 at no charge.

Supporting Low Credenzas

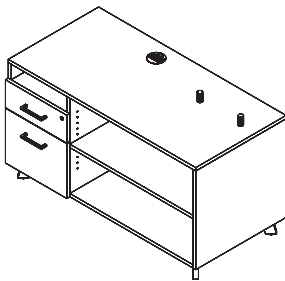

Support Low Credenza Left Box/File/Right Bookcase, Top with Spacers
(Silver spacers & tapered feet, H10S handles, face lock, 1 GRPRGR3S power grommet, 3 MMGR234S grommets, 1 adjustable shelf ¾")

Model#	Depth	Width	Height	Weight	Cube	Price
GRSSBF2048L	20"	48"	26 1/8"	150	13	\$2,737
GRSSBF2448L	24"	48"	26 1/8"	167	16	\$2,811

Top is predrilled for 2 right spacers, silver power grommet center top, left silver grommet on adjustable shelf, bottom shelf & back panel. **Handle Option:** Specify H3B-H10B, H13 & H14 at no charge.
Upgrade spacers & feet color at no charge: for Black add GRUSFB • for White add GRUSFW.
 May specify no spacers at no charge.

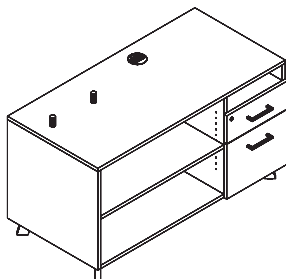

Support Low Credenza Right Box/File/Left Bookcase, Top w/ Spacers
(Silver spacers & tapered feet, H10S handles, face lock, 1 GRPRGR3S power grommet, 3 MMGR234S grommets, 1 adjustable shelf ¾")

Model#	Depth	Width	Height	Weight	Cube	Price
GRSSBF2048R	20"	48"	26 1/8"	150	13	\$2,737
GRSSBF2448R	24"	48"	26 1/8"	167	16	\$2,811

Top is predrilled for 2 left spacers, silver power grommet center top, left silver grommet on adjustable shelf, bottom shelf & back panel. **Handle Option:** Specify H3B-H10B, H13 & H14 at no charge.
Upgrade spacers & feet color at no charge: for Black add GRUSFB • for White add GRUSFW.
 May specify no spacers at no charge.

gravity series

Supporting Low Credenzas

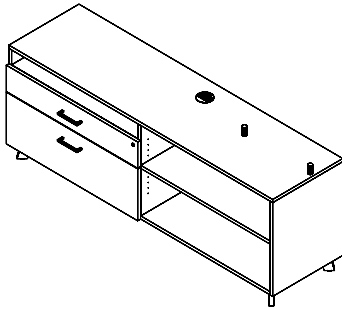

Support Low Credenza Left Box/Lateral/Right Bookcase, Top with Spacers
(Silver spacers & tapered feet, H10S handles, face lock, 1 GRPRGR3S power grommet, 3 MMGR234S grommets, 1 adjustable shelf ¾")

Model#	Depth	Width	Height	Weight	Cube	Price
GRSSBL2060L	20"	60"	26 ⅛"	189	16	\$2,886
GRSSBL2066L	20"	66"	26 ⅛"	200	18	\$2,930
GRSSBL2072L	20"	72"	26 ⅛"	210	20	\$2,974
GRSSBL2460L	24"	60"	26 ⅛"	210	20	\$2,970
GRSSBL2466L	24"	66"	26 ⅛"	222	22	\$3,020
GRSSBL2472L	24"	72"	26 ⅛"	235	23	\$3,071

Top is predrilled for 2 right spacers, silver power grommet center top, left silver grommet on adjustable shelf, bottom shelf & back panel. **Handle Option:** Specify H3B-H10B, H13 & H14 at no charge.
Upgrade spacers & feet color at no charge: for Black add GRUSFB • for White add GRUSFW.
May specify no spacers at no charge.

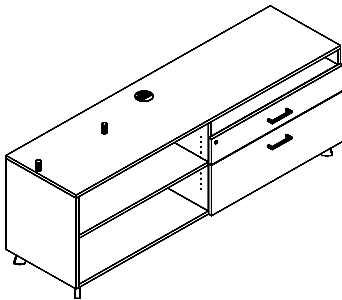

Support Low Credenza Right Box/Lateral/Left Bookcase, Top with Spacers
(Silver spacers & tapered feet, H10S handles, face lock, 1 GRPRGR3S power grommet, 3 MMGR234S grommets, 1 adjustable shelf ¾")

Model#	Depth	Width	Height	Weight	Cube	Price
GRSSBL2060R	20"	60"	26 ⅛"	189	16	\$2,886
GRSSBL2066R	20"	66"	26 ⅛"	200	18	\$2,930
GRSSBL2072R	20"	72"	26 ⅛"	210	20	\$2,974
GRSSBL2460R	24"	60"	26 ⅛"	210	20	\$2,970
GRSSBL2466R	24"	66"	26 ⅛"	222	22	\$3,020
GRSSBL2472R	24"	72"	26 ⅛"	235	23	\$3,071

Top is predrilled for 2 left spacers, silver power grommet center top, left silver grommet on adjustable shelf, bottom shelf & back panel. **Handle Option:** Specify H3B-H10B, H13 & H14 at no charge.
Upgrade spacers & feet color at no charge: for Black add GRUSFB • for White add GRUSFW.
May specify no spacers at no charge.

Note: Install Low Credenzas from user side top, 20"D or 24"D under the top, towards approach side.

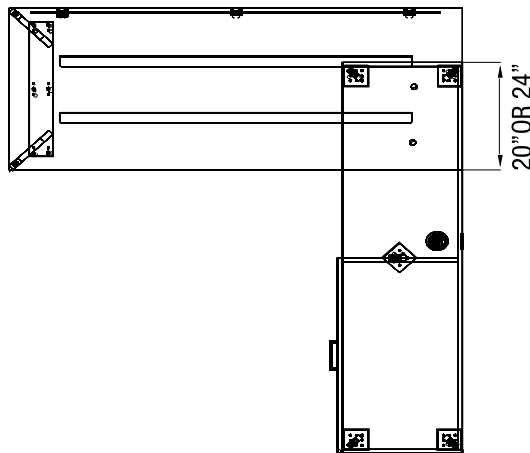

gravity series

Worksurface Support (Hardware, Stabilizer bars and Metal Legs)

Connecting Hardware

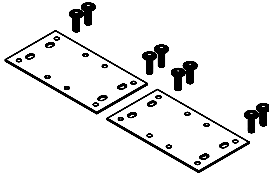

Connecting Hardware (2 Brackets/8 bolts)

Model#	Depth	Width	Height	Return or Bridge Top	Weight	Cube	Price
GRGANG20	4"	6"	25"	20"D	2	1	\$54/ea.
GRGANG24	4"	6"	25"	24"D	3	1	\$54/ea.

Required if connecting tops, field install: For L-Shape return top 2 brackets & 8 bolts GRGANG20 qty 1 or GRGANG24 qty 1.
Required: For U-Shapes bridge top 4 brackets & 16 bolts GRGANG24 qty 2 or GRGANG20 qty 2.
Hardware includes 2 brackets & 8 bolts 8x1" for field install.

Stabilizer Bar

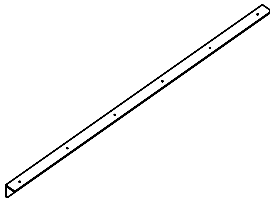

Stabilizer Bar for support (Black)

Model#	Depth	Width	Height	Top Width	Weight	Cube	Price
GRSB54	2"	35"	2"	60"	5	1	\$141/ea.
GRSB60	2"	44"	2"	60"	6	1	\$155/ea.
GRSB66	2"	50"	2"	66"	7	1	\$167/ea.
GRSB72	2"	56"	2"	72"	8	1	\$181/ea.

Required for 60", 66" & 72"W top support depending on configuration set up, see specification guide below.

Specification Guide

Stabilizer Bar Specification Guide

Worksurface Required Stabilizer Bar

Support 1	Support 2	Top 72"W	Top 66"W	Top 60"W	Top 54"W
Tapered Leg	Tapered Leg	(2) GRSB72	(2) GRSB66	(2) GRSB60	(2) GRSB54
Tapered Leg	Pedestal Pencil/Box/File	(2) GRSB72	(2) GRSB66	(2) GRSB60	(2) GRSB54
Tapered Leg	Low Credenza	(2) GRSB72	(2) GRSB66	(2) GRSB60	(2) GRSB54
Tapered Leg	Pedestal Lateral File	N/A	N/A	N/A	N/A
Tapered Leg	Pedestal Utility Cabinet	N/A	N/A	N/A	N/A
Pedestal Pencil/Box/File	Pedestal Pencil/Box/File	(2) GRSB66	(2) GRSB60	(2) GRSB54	(2) GRSB54
Pedestal Pencil/Box/File	Low Credenza	(2) GRSB66	(2) GRSB60	(2) GRSB54	(2) GRSB54

Stabilizer bar to be field installed below top equally spaced, for support.

Metal Legs

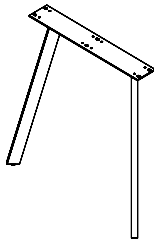

Tapered Metal Leg (Silver)

Model#	Depth	Width	Height	Fits Top Depth	Weight	Cube	Price
GROTL20	20"	2"	28"	20"	15	3	\$638
GROTL24	24"	2"	28"	24"	22	3	\$676
GROTL30	30"	2"	28"	30"	26	4	\$712

Silver legs are standard. 2 Stabilizer Bar required for 60", 66" & 72"W tops when supporting with left & right leg.
Upgrade leg color at no charge. Specify: GRULEGB Black • GRULEGW White • GRULEGR Red • GRULEGO Orange • GRULEGLB Light Blue • GRULEGDB Dark Blue.
Bright colors lead time 20 days: Red • Orange • Light Blue • Dark Blue.

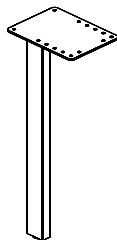

Single Post Metal Leg (Silver)

Model#	Depth	Width	Height	Fits Top Depth	Weight	Cube	Price
GRSPL28	2"	1"	28"	20"/24"/30"	7	1	\$306

Silver Leg standard, 1 leg is required for center support in bridge top or where additional support is required.
Upgrade leg color at no charge. Specify: GRULEGB Black • GRULEGW White • GRULEGR Red • GRULEGO Orange, GRULEGLB Light Blue • GRULEGDB Dark Blue. (Field install with #8x1 wood screws)
Bright colors lead time 20 days: Red • Orange • Light Blue • Dark Blue.

gravity series

Privacy Screens/Modesty

(For worksurfaces, can be used as privacy screens or modesty panels)

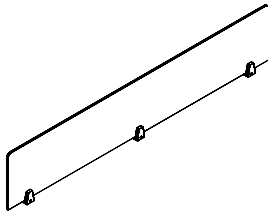

Frosted Acrylic Privacy Screen/Modesty Panel (Two radius corners, silver mount clips)

Model#	Depth	Width	Height	Mount Clips	Fits Top	Weight	Cube	Price
GRPSF2412	3/8"	17"	12 5/8"	2	24"D (Depth Side)	4	1	\$207
GRPSF3012	3/8"	23"	12 5/8"	2	30"D (Depth Side)	6	1	\$259
GRPSF4812	3/8"	41"	12 5/8"	2	48"	9	1	\$406
GRPSF6012	3/8"	53"	12 5/8"	3	60"	11	1	\$535
GRPSF6612	3/8"	59"	12 5/8"	3	66"	12	1	\$587
GRPSF7212	3/8"	65"	12 5/8"	3	72"	13	1	\$631

Install as privacy screen or modesty, tops are not predrilled.
Mount clips color: may be specified in black or white at no charge.

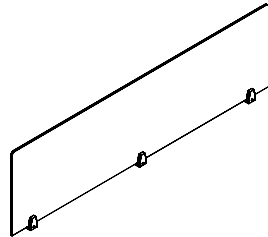

Frosted Acrylic Privacy Screen/Modesty Panel (Two radius corners, silver mount clips)

Model#	Depth	Width	Height	Mount Clips	Fits Top	Weight	Cube	Price
GRPSF2418	3/8"	17"	18 5/8"	2	24"D (Depth Side)	5	1	\$276
GRPSF3018	3/8"	23"	18 5/8"	2	30"D (Depth Side)	7	1	\$354
GRPSF4818	3/8"	41"	18 5/8"	2	48"	11	1	\$570
GRPSF6018	3/8"	53"	18 5/8"	3	60"	15	1	\$750
GRPSF6618	3/8"	59"	18 5/8"	3	66"	16	1	\$820
GRPSF7218	3/8"	65"	18 5/8"	3	72"	18	1	\$898

Install as privacy screen or modesty, tops are not predrilled.
Mount clips color: may be specified in black or white at no charge.

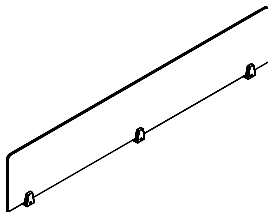

Clear Acrylic Privacy Screen/Modesty Panel (Two radius corners, silver mount clips)

Model#	Depth	Width	Height	Mount Clips	Fits Top	Weight	Cube	Price
GRPSC2412	3/8"	17"	12 5/8"	2	24"D (Depth Side)	4	1	\$200
GRPSC3012	3/8"	23"	12 5/8"	2	30"D (Depth Side)	6	1	\$241
GRPSC4812	3/8"	41"	12 5/8"	2	48"	9	1	\$371
GRPSC6012	3/8"	53"	12 5/8"	3	60"	11	1	\$491
GRPSC6612	3/8"	59"	12 5/8"	3	66"	12	1	\$535
GRPSC7212	3/8"	65"	12 5/8"	3	72"	13	1	\$578

Install as privacy screen or modesty, tops are not predrilled.
Mount clips color: may be specified in black or white at no charge.

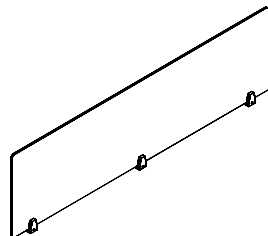

Clear Acrylic Privacy Screen/Modesty Panel (Two radius corners, silver mount clips)

Model#	Depth	Width	Height	Mount Clips	Fits Top	Weight	Cube	Price
GRPSC2418	3/8"	17"	18 5/8"	2	24"D (Depth Side)	5	1	\$259
GRPSC3018	3/8"	23"	18 5/8"	2	30"D (Depth Side)	7	1	\$329
GRPSC4818	3/8"	41"	18 5/8"	2	48"	11	1	\$526
GRPSC6018	3/8"	53"	18 5/8"	3	60"	15	1	\$700
GRPSC6618	3/8"	59"	18 5/8"	3	66"	16	1	\$770
GRPSC7218	3/8"	65"	18 5/8"	3	72"	18	1	\$829

Install as privacy screen or modesty, tops are not predrilled.
Mount clips color: may be specified in black or white at no charge.

gravity series

Privacy Screens (for worksurfaces)

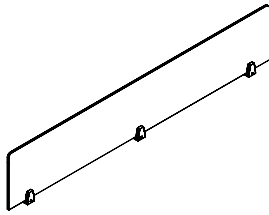

TFM Privacy Screen (Two radius corners, silver mount clips)

Model#	Depth	Width	Height	Mount Clips	Fits Top	Weight	Cube	Price
GRPSW2412	3/4"	17"	12 5/8"	2	24"D (Depth Side)	5	1	\$192
GRPSW3012	3/4"	23"	12 5/8"	2	30"D (Depth Side)	6	1	\$192
GRPSW4812	3/4"	41"	12 5/8"	2	48"	11	1	\$227
GRPSW6012	3/4"	53"	12 5/8"	3	60"	14	1	\$286
GRPSW6612	3/4"	59"	12 5/8"	3	66"	15	1	\$296
GRPSW7212	3/4"	65"	12 5/8"	3	72"	16	1	\$296

Install as privacy screen, tops are not predrilled. Mount clips color: may be specified in black or white at no charge.

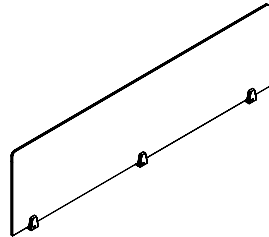

TFM Privacy Screen (Two radius corners, silver mount clips)

Model#	Depth	Width	Height	Mount Clips	Fits Top	Weight	Cube	Price
GRPSW2418	3/4"	17"	18 5/8"	2	24"D (Depth Side)	7	1	\$316
GRPSW3018	3/4"	23"	18 5/8"	2	30"D (Depth Side)	9	1	\$316
GRPSW4818	3/4"	41"	18 5/8"	2	48"	16	1	\$386
GRPSW6018	3/4"	53"	18 5/8"	3	60"	20	1	\$468
GRPSW6618	3/4"	59"	18 5/8"	3	66"	22	1	\$490
GRPSW7218	3/4"	65"	18 5/8"	3	72"	24	1	\$490

Install as privacy screen, tops are not predrilled. Mount clips color: may be specified in black or white at no charge.

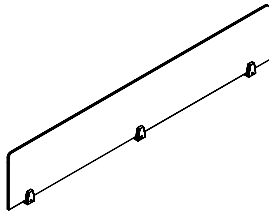

HPL Privacy Screen (Two radius corners, silver mount clips)

Model#	Depth	Width	Height	Mount Clips	Fits Top	Weight	Cube	Price
GRPSHP2412	3/4"	17"	12 5/8"	2	24"D (Depth Side)	5	1	\$250
GRPSHP3012	3/4"	23"	12 5/8"	2	30"D (Depth Side)	6	1	\$250
GRPSHP4812	3/4"	41"	12 5/8"	2	48"	11	1	\$336
GRPSHP6012	3/4"	53"	12 5/8"	3	60"	14	1	\$428
GRPSHP6612	3/4"	59"	12 5/8"	3	66"	15	1	\$458
GRPSHP7212	3/4"	65"	12 5/8"	3	72"	16	1	\$458

Install as privacy screen, tops are not predrilled. Mount clips color: may be specified in black or white at no charge.

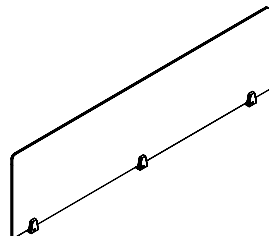

HPL Privacy Screen (Two radius corners, silver mount clips)

Model#	Depth	Width	Height	Mount Clips	Fits Top	Weight	Cube	Price
GRPSHP2418	3/4"	17"	18 5/8"	2	24"D (Depth Side)	7	1	\$432
GRPSHP3018	3/4"	23"	18 5/8"	2	30"D (Depth Side)	9	1	\$432
GRPSHP4818	3/4"	41"	18 5/8"	2	48"	16	1	\$604
GRPSHP6018	3/4"	53"	18 5/8"	3	60"	20	1	\$754
GRPSHP6618	3/4"	59"	18 5/8"	3	66"	22	1	\$814
GRPSHP7218	3/4"	65"	18 5/8"	3	72"	24	1	\$814

Install as privacy screen, tops are not predrilled. Mount clips color: may be specified in black or white at no charge.

For color options, see page 196.

gravity series

Modesty Panels (for worksurfaces)

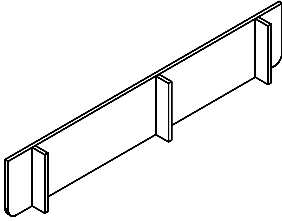

TFM Modesty Panel (Two radius corners, 3/4" thick)

Model#	Depth	Width	Height	Dividers	Fits Top	Weight	Cube	Price
GRMPW2412	4"	17"	12"	2	24"D (Depth Side)	5	1	\$192
GRMPW3012	4"	23"	12"	2	30"D (Depth Side)	6	1	\$192
GRMPW4812	4"	41"	12"	2	48"	11	2	\$227
GRMPW6012	4"	53"	12"	3	60"	14	2	\$286
GRMPW6612	4"	59"	12"	3	66"	15	2	\$296
GRMPW7212	4"	65"	12"	3	72"	16	2	\$296

Install as modesty, tops are not predrilled. Wood grain colors run horizontal.

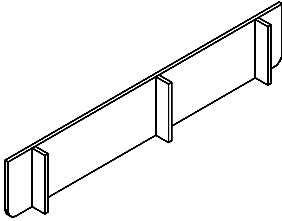

TFM Modesty Panel (Two radius corners, 3/4" Thick)

Model#	Depth	Width	Height	Dividers	Fits Top	Weight	Cube	Price
GRMPW2418	4"	17"	18"	2	24"D (Depth Side)	7	1	\$316
GRMPW3018	4"	23"	18"	2	30"D (Depth Side)	9	1	\$316
GRMPW4818	4"	41"	18"	2	48"	16	2	\$386
GRMPW6018	4"	53"	18"	3	60"	20	2	\$468
GRMPW6618	4"	59"	18"	3	66"	22	2	\$490
GRMPW7218	4"	65"	18"	3	72"	24	2	\$490

Install as modesty, tops are not predrilled. Wood grain colors run horizontal.

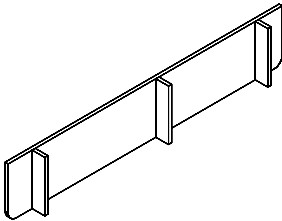

HPL Modesty Panel (Two radius corners, 3/4" thick)

Model#	Depth	Width	Height	Dividers	Fits Top	Weight	Cube	Price
GRMPHP2412	4"	17"	12"	2	24"D (Depth Side)	5	1	\$250
GRMPHP3012	4"	23"	12"	2	30"D (Depth Side)	6	1	\$250
GRMPHP4812	4"	41"	12"	2	48"	11	2	\$336
GRMPHP6012	4"	53"	12"	3	60"	14	2	\$428
GRMPHP6612	4"	59"	12"	3	66"	15	2	\$458
GRMPHP7212	4"	65"	12"	3	72"	16	2	\$458

Install as modesty, tops are not predrilled. See color chart for HPL Bright Colors.

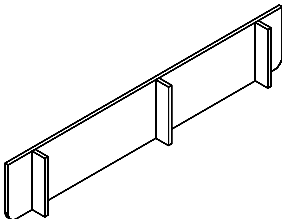

HPL Modesty Panel (Two radius corners, 3/4" thick)

Model#	Depth	Width	Height	Dividers	Fits Top	Weight	Cube	Price
GRMPHP2418	4"	17"	18"	2	24"D (Depth Side)	7	1	\$432
GRMPHP3018	4"	23"	18"	2	30"D (Depth Side)	9	1	\$432
GRMPHP4818	4"	41"	18"	2	48"	16	2	\$604
GRMPHP6018	4"	53"	18"	3	60"	20	2	\$754
GRMPHP6618	4"	59"	18"	3	66"	22	2	\$814
GRMPHP7218	4"	65"	18"	3	72"	24	2	\$814

Install as modesty, tops are not predrilled. See color chart for HPL Bright Colors.

For color options, see page 196.

gravity series

Privacy Screens

Tackable Fabric Privacy Screens

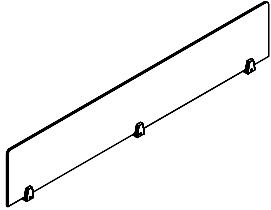

Tackable Fabric Privacy Screen (Two radius corners, silver mount clips)

Model#	Depth	Width	Height	Mount Clips	Fits Top	Weight	Cube	Price
GRPSTB2412	1/2"	17"	12 5/8"	2	24"D (Depth Side)	2	1	\$329
GRPSTB3012	1/2"	23"	12 5/8"	2	30"D (Depth Side)	2	1	\$366
GRPSTB4812	1/2"	41"	12 5/8"	2	48"	4	1	\$468
GRPSTB6012	1/2"	53"	12 5/8"	3	60"	5	1	\$591
GRPSTB6612	1/2"	59"	12 5/8"	3	66"	5	1	\$604
GRPSTB7212	1/2"	65"	12 5/8"	3	72"	6	1	\$644

Install as privacy screen, tops are not predrilled.
Mount clips color: may be specified in black or white at no charge.

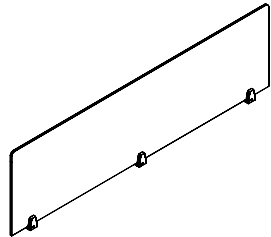

Tackable Fabric Privacy Screen (Two radius corners, silver mount clips)

Model#	Depth	Width	Height	Mount Clips	Fits Top	Weight	Cube	Price
GRPSTB2418	1/2"	17"	18 5/8"	2	24"D (Depth Side)	3	1	\$382
GRPSTB3018	1/2"	23"	18 5/8"	2	30"D (Depth Side)	3	1	\$427
GRPSTB4818	1/2"	41"	18 5/8"	2	48"	6	1	\$565
GRPSTB6018	1/2"	53"	18 5/8"	3	60"	7	1	\$693
GRPSTB6618	1/2"	59"	18 5/8"	3	66"	8	1	\$739
GRPSTB7218	1/2"	65"	18 5/8"	3	72"	9	1	\$775

Install as privacy screen, tops are not predrilled.
Mount clips color: may be specified in black or white at no charge.

Markerboard Privacy Screens

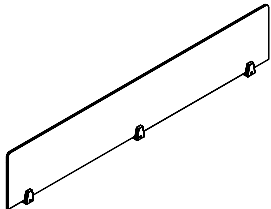

Markerboard Privacy Screen, Silver (Two radius corners, writable board, silver mount clips)

Model#	Depth	Width	Height	Mount Clips	Fits Top	Weight	Cube	Price
GRPSMB2412	1/2"	17"	12 5/8"	2	24"D (Depth Side)	5	1	\$485
GRPSMB3012	1/2"	23"	12 5/8"	2	30"D (Depth Side)	6	1	\$515
GRPSMB4812	1/2"	41"	12 5/8"	2	48"	11	1	\$613
GRPSMB6012	1/2"	53"	12 5/8"	3	60"	14	1	\$714
GRPSMB6612	1/2"	59"	12 5/8"	3	66"	15	1	\$747
GRPSMB7212	1/2"	65"	12 5/8"	3	72"	16	1	\$780

Silver is standard. Install as privacy screen, tops are not predrilled. Edge band color will match worksurface. Upgrade color at no charge. Specify: GRUPSMBB Blue • GRUPSMBR Red • GRUPSMBO Orange • GRUPSMBW White. Mount clips color: may be specified in black or white at no charge.
Note: Leaving marker writing on board for more than 48 hrs will result in permanent stains.

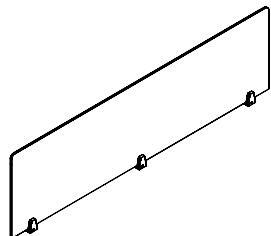

Markerboard Privacy Screen, Silver (Two radius corners, writable board, silver mount clips)

Model#	Depth	Width	Height	Mount Clips	Fits Top	Weight	Cube	Price
GRPSMB2418	1/2"	17"	18 5/8"	2	24"D (Depth Side)	7	1	\$486
GRPSMB3018	1/2"	23"	18 5/8"	2	30"D (Depth Side)	9	1	\$517
GRPSMB4818	1/2"	41"	18 5/8"	2	48"	16	1	\$614
GRPSMB6018	1/2"	53"	18 5/8"	3	60"	20	1	\$716
GRPSMB6618	1/2"	59"	18 5/8"	3	66"	22	1	\$748
GRPSMB7218	1/2"	65"	18 5/8"	3	72"	24	1	\$781

Silver is standard. Install as privacy screen, tops are not predrilled. Edge band color will match worksurface. Matching edgeband N/A. Upgrade color at no charge. Specify: GRUPSMBB Blue • GRUPSMBR Red • GRUPSMBO Orange • GRUPSMBW White. Mount clips color: may be specified in black or white at no charge.
Note: Leaving marker writing on board for more than 48 hrs will result in permanent stains.

For color and fabric options, see page 196.

gravity series

Freestanding Storage

Pedestals

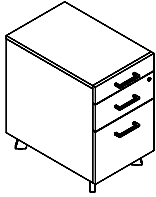

Freestanding Pedestal Pencil/Box/File (Silver tapered feet, H10S handles, face lock)

Model#	Depth	Width	Height	Weight	Cube	Price
GRPEDEM20	20"	16"	26 1/8"	86	5	\$1,422
GRPEDEM24	24"	16"	26 1/8"	93	6	\$1,456

Upgrade feet color at no charge: for black add GRUFB • for white add GRUFW.
Handle option: Specify H3B-H10B, H13 & H14 at no charge.

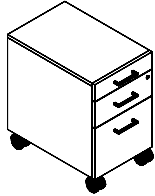

Mobile Pedestal Pencil/Box/File with Casters (H10S handles, face lock)

Model#	Depth	Width	Height	Weight	Cube	Price
GRPEDEX20	20"	16"	26 1/8"	86	5	\$1,213
GRPEDEX24	24"	16"	26 1/8"	93	6	\$1,246

Uses APCAS black casters 3 1/2" H. Overall height 26 1/8". Handle option: Specify H3B-H10B, H13 & H14 at no charge.

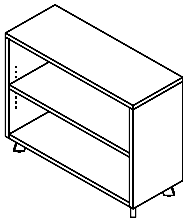

Bookcases

Bookcase (Silver tapered feet, adjustable shelves 1")

Model#	Depth	Width	Height	Adj Shelves	Weight	Cube	Price
GRBC30	12"	36"	29"	1	66	8	\$965
GRBC65	12"	36"	65"	3	137	17	\$1,408
GRBC72	12"	36"	72"	4	164	18	\$1,562

Upgrade feet color at no charge: for black add GRUFB • for white add GRUFW.
Adjustable shelves recommended weight 20 lbs each, distributed evenly.

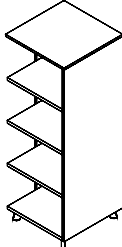

Corner Bookcase Left (Left half end panel, silver tapered feet, adjustable shelves 1")

Model#	Depth	Width	Height	Adj Shelves	Weight	Cube	Price
GRBCC2065L	20"	24"	65"	3	168	18	\$1,687
GRBCC2465L	24"	24"	65"	3	195	21	\$1,761

Upgrade feet color at no charge: for black add GRUFB • for white add GRUFW.
Adjustable shelves recommended weight 20 lbs each, distributed evenly.

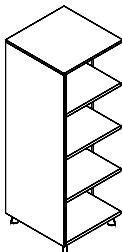

Corner Bookcase Right (Right half end panel, silver tapered feet, adjustable shelves 1")

Model#	Depth	Width	Height	Adj Shelves	Weight	Cube	Price
GRBCC2065R	20"	24"	65"	3	168	18	\$1,687
GRBCC2465R	24"	24"	65"	3	195	21	\$1,761

Upgrade feet color at no charge: for black add GRUFB • for white add GRUFW.
Adjustable shelves recommended weight 20 lbs each, distributed evenly.

Storage Credenzas

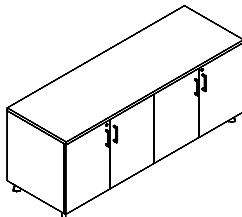

Credenza 4 Full Hinged Doors (Silver tapered feet, H10S handles, 2 face locks, adjustable shelves 3/4")

Model#	Depth	Width	Height	Adj Shelves	Weight	Cube	Price
GRC2072 1FP	20"	72"	29"	2	260	25	\$3,296
GRC2472 1FP	24"	72"	29"	2	295	30	\$3,412

Upgrade feet color at no charge: for black add GRUFB • for white add GRUFW.
Handle option: Specify H3B-H10B, H13 & H14 at no charge.

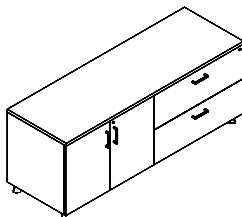

Credenza Left Hinged Door Cabinet/Right Lateral File (Silver tapered feet, H10S handles, 2 face locks, adjustable shelf 3/4")

Model#	Depth	Width	Height	Adj Shelves	Weight	Cube	Price
GRC2072 9FP	20"	72"	29"	2	270	30	\$3,533
GRC2472 9FP	24"	72"	29"	2	290	30	\$3,647

Upgrade feet color at no charge: for black add GRUFB • for white add GRUFW.
Handle option: Specify H3B-H10B, H13 & H14 at no charge. Can specify Left Lateral File/Right Hinged Door Cabinet at no charge.

gravity series

Freestanding Storage

Storage Cabinets

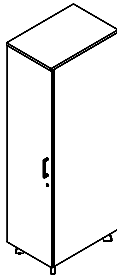

Single Storage Cabinet, Left Door (Silver tapered feet, H10S handle, face lock, adjustable shelves ¾")

Model#	Depth	Width	Height	Adj Shelves	Weight	Cube	Price
GRSTS2065L	20"	16"	65"	3	135	13	\$2,155
GRSTS2465L	24"	16"	65"	3	151	15	\$2,276

**Upgrade feet color at no charge: for black, add GRUFB • for white, add GRUFW.
Handle option: Specify H3B-H10B, H13 & H14 at no charge.**

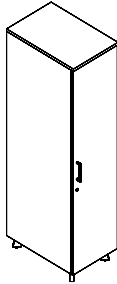

Single Storage Cabinet, Right Door (Silver tapered feet, H10S handle, face lock, adjustable shelves ¾")

Model#	Depth	Width	Height	Adj Shelves	Weight	Cube	Price
GRSTS2065R	20"	16"	65"	3	135	13	\$2,155
GRSTS2465R	24"	16"	65"	3	151	15	\$2,276

**Upgrade feet color at no charge: for black, add GRUFB • for white, add GRUFW.
Handle option: Specify H3B-H10B, H13 & H14 at no charge.**

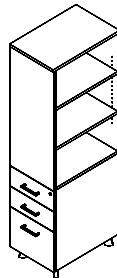

Single Personal Bookcase Cabinet with BBF, Left (Silver tapered feet, H10S handles, face lock, right adj shelves ¾")

Model#	Depth	Width	Height	Adj Shelves	Weight	Cube	Price
GRBCPS2065L	20"	16"	65"	2	143	13	\$2,309
GRBCPS2465L	24"	16"	65"	2	157	15	\$2,425

**Upgrade feet color at no charge: for black, add GRUFB • for white, add GRUFW.
Handle option: Specify H3B-H10B, H13 & H14 at no charge.**

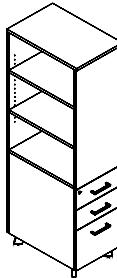

Single Personal Bookcase Cabinet with BBF, Right (Silver tapered feet, H10S handles, face lock, left adj shelves ¾")

Model#	Depth	Width	Height	Adj Shelves	Weight	Cube	Price
GRBCPS2065R	20"	16"	65"	2	143	13	\$2,309
GRBCPS2465R	24"	16"	65"	2	157	15	\$2,425

**Upgrade feet color at no charge: for black, add GRUFB • for white, add GRUFW.
Handle option: Specify H3B-H10B, H13 & H14 at no charge.**

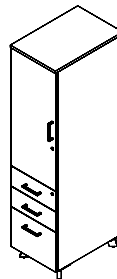

Single Personal Cabinet with BBF, Left Door (Silver tapered feet, H10S handles, 2 face locks, adjustable shelves ¾")

Model#	Depth	Width	Height	Adj Shelves	Weight	Cube	Price
GRBCV2065L	20"	16"	65"	2	153	13	\$2,554
GRBCV2465L	24"	16"	65"	2	167	15	\$2,632

**Upgrade feet color at no charge: for black, add GRUFB • for white, add GRUFW.
Handle option: Specify H3B-H10B, H13 & H14 at no charge.**

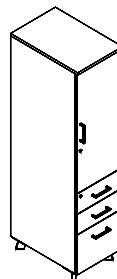

Single Personal Cabinet with BBF, Right Door (Silver tapered feet, H10S handles, 2 face locks, adjustable shelves ¾")

Model#	Depth	Width	Height	Adj Shelves	Weight	Cube	Price
GRBCV2065R	20"	16"	65"	2	153	13	\$2,554
GRBCV2465R	24"	16"	65"	2	167	15	\$2,632

**Upgrade feet color at no charge: for black, add GRUFB • for white, add GRUFW.
Handle option: Specify H3B-H10B, H13 & H14 at no charge.**

gravity series

Overhead Storage Cabinets

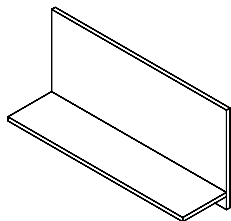
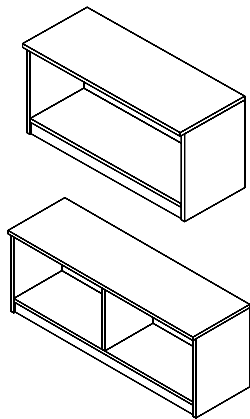
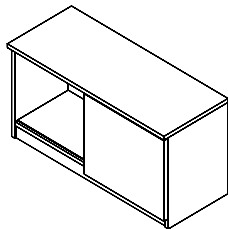
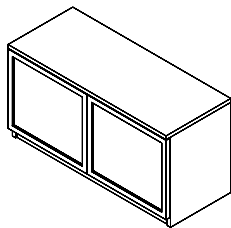
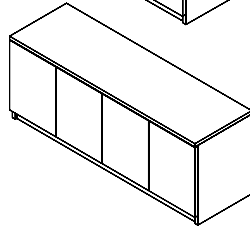
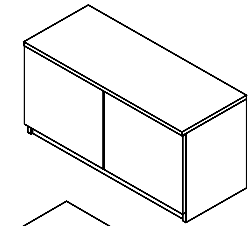

Wallmount Cabinet Hinged Doors, with Fascia

Model#	Depth	Width	Height	Doors	Weight	Cube	Price
GRCFOHD30	14 3/4"	30"	18 1/2"	2	58	5	\$1,107
GRCFOHD36	14 3/4"	36"	18 1/2"	2	67	6	\$1,138
GRCFOHD42	14 3/4"	42"	18 1/2"	2	79	7	\$1,306
GRCFOHD48	14 3/4"	48"	18 1/2"	4	87	8	\$1,347

Optional add: Tasklight GRTSKLTX24 \$291. Face lock MMFL \$118/each. (2 locks required for 42"W & 48"W). Cabinets required professional installation & must be mounted to wall studs. Weight capacity 35lb. distributed evenly. 42"W & 48"W have center divider.

Wallmount Cabinet Frosted Glass Doors, with Fascia

Model#	Depth	Width	Height	Doors	Weight	Cube	Price
GRCFOHG36	14 3/4"	36"	18 1/2"	2	63	6	\$1,369

Optional add: Tasklight GRTSKLTX24 \$291. (Lock not available) Cabinets required professional installation & must be mounted to wall studs. Weight capacity 35lb. distributed evenly.

Wallmount Cabinet One Sliding Door, with Fascia

Model#	Depth	Width	Height	Doors	Weight	Cube	Price
GRCFOHS30	14 3/4"	30"	18 1/2"	1	58	5	\$1,049
GRCFOHS36	14 3/4"	36"	18 1/2"	1	65	6	\$1,194
GRCFOHS42	14 3/4"	42"	18 1/2"	1	71	7	\$1,340
GRCFOHS48	14 3/4"	48"	18 1/2"	1	78	8	\$1,426

Optional add: Tasklight GRTSKLTX24 \$291. (Lock not available) Cabinets required professional installation & must be mounted to wall studs. Weight capacity 35lb. distributed evenly.

Wallmount Cabinet Open, with Fascia (No doors)

Model#	Depth	Width	Height	Weight	Cube	Price
GRCFOHO30	14 3/4"	30"	18 1/2"	47	5	\$757
GRCFOHO36	14 3/4"	36"	18 1/2"	53	6	\$899
GRCFOHO42	14 3/4"	42"	18 1/2"	63	7	\$1,042
GRCFOHO48	14 3/4"	48"	18 1/2"	69	8	\$1,107

Optional add: Tasklight GRTSKLTX24 \$291. (Lock not available). 42"W & 48"W has center divider. Cabinets required professional installation & must be mounted to wall studs. Weight capacity 35lb. distributed evenly.

Wallmount Shelf with Back Panel (3/4" thick)

Model#	Depth	Width	Height	Weight	Cube	Price
GRCFOS24	11"	24"	17 3/4"	14	1	\$375
GRCFOS30	11"	30"	17 3/4"	18	1	\$388
GRCFOS36	11"	36"	17 3/4"	21	1	\$404

Color combination N/A. Shelf is 10"D. Weight capacity 25lb. distributed evenly. Ships disassembled with mounting hardware.

gravity series

Hutches

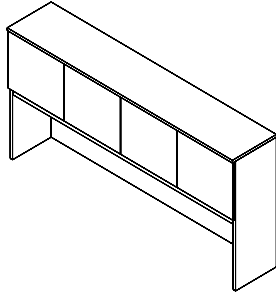

Hutch 4 TFM Hinged Doors, with Fascia (Bottom clearance 17 1/4" from fascia)

Model#	Depth	Width	Height	Weight	Cube	Price
GRH48WD	14"	48"	36"	108	14	\$1,359
GRH60WD	14"	60"	36"	129	18	\$1,487
GRH66WD	14"	66"	36"	139	20	\$1,579
GRH72WD	14"	72"	36"	149	21	\$1,641

Optional Tasklight add GRTSKLTX24 \$291/each. Face Lock \$118/each. (4 doors requires 2 locks).
Weight capacity 35lb. distributed evenly.

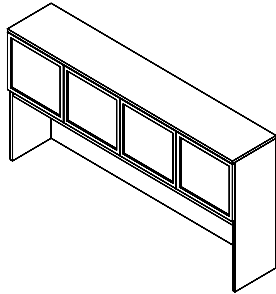

Hutch 4 Frosted Glass Doors, with Fascia (Bottom clearance 17 1/4" from fascia)

Model#	Depth	Width	Height	Weight	Cube	Price
GRH72WG	14"	72"	36"	145	21	\$2,336

Optional Tasklight add GRTSKLTX24 \$291/each. (Locks N/A) Weight capacity 35lb. distributed evenly.

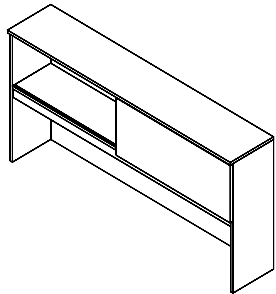

Hutch One Sliding Door, with Fascia (Bottom clearance 17 1/4" from fascia)

Model#	Depth	Width	Height	Weight	Cube	Price
GRH48SD	14"	48"	36"	99	14	\$1,377
GRH60SD	14"	60"	36"	118	18	\$1,552
GRH66SD	14"	66"	36"	130	20	\$1,578
GRH72SD	14"	72"	36"	136	21	\$1,640

Optional Tasklight add GRTSKLTX24 \$291/each. (Locks N/A) Weight capacity 35lb. distributed evenly.

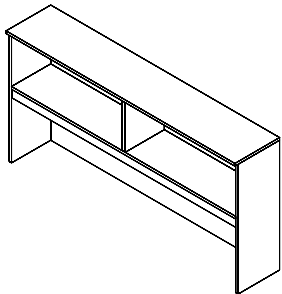

Hutch No Doors, with Fascia (Bottom clearance 17 1/4" from fascia)

Model#	Depth	Width	Height	Weight	Cube	Price
GRH48ND	14"	48"	36"	92	14	\$1,029
GRH60ND	14"	60"	36"	109	18	\$1,122
GRH66ND	14"	66"	36"	116	20	\$1,187
GRH72ND	14"	72"	36"	125	21	\$1,249

Optional Tasklight add GRTSKLTX24 \$291/each. (Locks N/A) Weight capacity 35lb. distributed evenly.

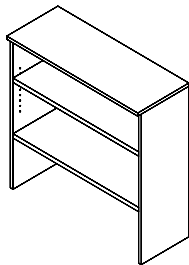

Bookcase Hutch

Bookcase Hutch, 1 Fixed & 1 Adjustable Shelf (Bottom clearance 12"H)

Model#	Depth	Width	Height	Weight	Cube	Price
GRBCH36	14"	36"	36"	79	11	\$632

Weight capacity 35lb. distributed evenly. 1" thick shelves.

HUTCH NOTE: Optional Tasklight includes grommet on back panel.

gravity series

Accessories

Hutch Options

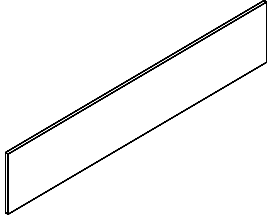

Tackboards (For hutches or wallmount)

Model#	Depth	Width	Height	Fits Hutch Width	Weight	Cube	Price
MMTKBD30	1/2"	30"	14 1/4"		9	.5	\$545
MMTKBD36	1/2"	36"	14 1/4"		9	.5	\$567
MMTKBD42	1/2"	42"	14 1/4"	48"	12	.6	\$587
MMTKBD48	1/2"	48"	14 1/4"		12	.6	\$632
MMTKBD54	1/2"	54"	14 1/4"	60"	15	.7	\$672
MMTKBD60	1/2"	60"	14 1/4"	66"	17	.8	\$713
MMTKBD66	1/2"	66"	14 1/4"	72"	19	1	\$824
MMTKBD72	1/2"	72"	14 1/4"		21	1	\$931

May purchase alone for wall mount, tackboards ship with hutch mounting hardware.

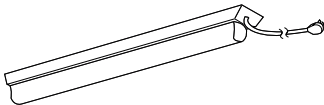

Tasklight, Black (Hutches include 1 grommet on back panel)

Model#	Depth	Width	Height	Weight	Cube	Price
GRTSKLTX24	7/8"	24 1/2"	1 7/8"	1	1	\$291/ea.

Option to add for wallmount cabinets, does not include grommet.
Ships installed. (LED light interconnect to other lights, link up to 6 units max).

Desk/Worksurface Options

Data/Power Grommet



Round Power Grommet (1 Power, 2 power USB, 1 switching adapter, 60" cord)

Model#	Depth	Width	Surface Hole Diameter	Color	Weight	Cube	Price
GRPRGR3S	3 1/2"	3 1/2"	3 3/16"	Silver	2	1	\$268
GRPRGR3B	3 1/2"	3 1/2"	3 3/16"	Black	2	1	\$268

Optional grommets add to desk shells, credenza shells or worksurfaces.
Specify grommet location: From user side right, center, or left side top.

Grommet Locations (Worksurface)

NOTE: While sitting at unit, grommet locations are named from left to right. Line drawings below show standard locations, please specify **grommet locations when adding option**.

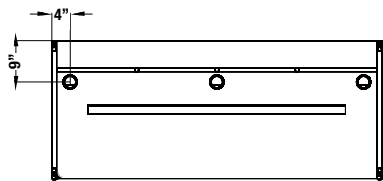

Desk Shell Rectangular Top

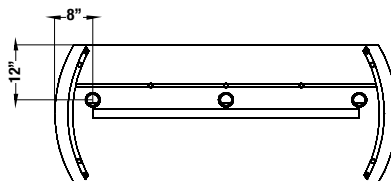

Desk Shell Curved Top

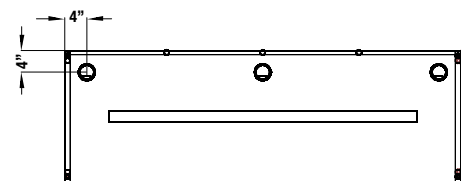

Credenza Top/Worksurfaces

NOTE: Silver grommets are standard in bridges, returns, & low credenzas tops.

gravity series

Receptions

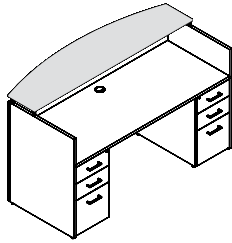

Reception Double Pedestal Desk Left & Right BBF, Fan Countertop Floating with Clear Glass
(Silver spacers, H10S handles, 2 locks, 1 MMGR234S grommet)

Model#	Depth	Width	Height	Weight	Cube	Price
GRCAD3072	30/36"	72"	42"	350	63	\$5,708

Silver grommet center top. Both pedestals include face lock.
Standard TFM modesty color matches the color of chassis ordered, unless otherwise specified.
Upgrade Modesty to HPL Metallic or Bright color, no charge.
Upgrade spacers color, no charge: For black add GRUSB for White add GRUSW.
Handle option: Specify H3B-H10B, H13 & H14 at no charge.

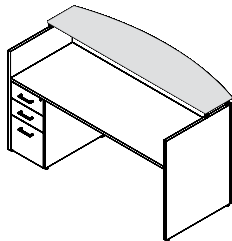

Reception Single Pedestal Desk Left BBF, Fan Countertop Floating with Clear Glass
(Silver spacers, H10S handles, 1 lock, 1 MMGR234S grommet)

Model#	Depth	Width	Height	Weight	Cube	Price
GRCAS3072L	30/36"	72"	42"	350	63	\$4,999

Silver grommet center top. Both pedestals include face lock.
Standard TFM modesty color matches the color of chassis ordered, unless otherwise specified.
Upgrade Modesty to HPL Metallic or Bright color, no charge.
Upgrade spacers color, no charge: For black add GRUSB for White add GRUSW.
Handle option: Specify H3B-H10B, H13 & H14 at no charge.

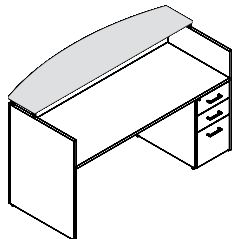

Reception Single Pedestal Desk Right BBF, Fan Countertop Floating with Clear Glass
(Silver spacers, H10S handles, 1 lock, 1 MMGR234S grommet)

Model#	Depth	Width	Height	Weight	Cube	Price
GRCAS3072R	30/36"	72"	42"	350	63	\$4,999

Silver grommet center top. Both pedestals include face lock.
Standard TFM modesty color matches the color of chassis ordered, unless otherwise specified.
Upgrade Modesty to HPL Metallic or Bright color, no charge.
Upgrade spacers color, no charge: For black add GRUSB for White add GRUSW.
Handle option: Specify H3B-H10B, H13 & H14 at no charge.

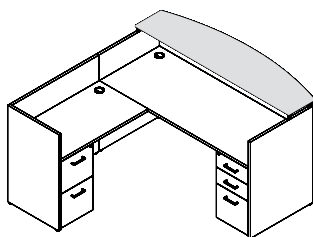

Reception L-Unit Left Return FF, Desk w/ Right BBF & Fan Countertop Floating w/ Clear Glass
(Silver spacers, H10S handles, 2 locks, 2 MMGR234S grommets)

Model#	Depth	Width	Height	Left Return	Weight	Cube	Price
GRCAX3072L	30/36"	72"	42"	24"D x 42"W	425	92	\$6,675

Silver grommet center top. Both pedestals include face lock.
Standard TFM modesty color matches the color of chassis ordered, unless otherwise specified.
Upgrade Modesty to HPL Metallic or Bright color, no charge.
Upgrade spacers color, no charge: For black add GRUSB for White add GRUSW.
Handle option: Specify H3B-H10B, H13 & H14 at no charge.

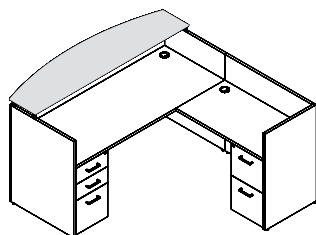

Reception L-Unit Right Return FF, Desk w/ Left BBF & Fan Countertop Floating w/ Clear Glass
(Silver spacers, H10S handles, 2 locks, 2 MMGR234S grommets)

Model#	Depth	Width	Height	Right Return	Weight	Cube	Price
GRCAX3072R	30/36"	72"	42"	24"D x 42"W	425	92	\$6,675

Silver grommet center top. Both pedestals include face lock.
Standard TFM modesty color matches the color of chassis ordered, unless otherwise specified.
Upgrade Modesty to HPL Metallic or Bright color, no charge.
Upgrade spacers color, no charge: For black add GRUSB for White add GRUSW.
Handle option: Specify H3B-H10B, H13 & H14 at no charge.

For modesty color upgrade, see page 195.

gravity series

Upgrade Options

Modesty Color Upgrade

Upgrade Modesty Panel Color (For reception main desk, desk shells, credenzas and bridges)			
Model#	HPL Metallic and Bright Color	Reception	Price
GRUMODS	Silver (TFM)	no upcharge	no upcharge
GRUMODPB	Pewter Brush	no upcharge	\$171
GRUMODAD	Aluminum Dots	no upcharge	\$171
GRUMODR	Ruby	no upcharge	\$171
GRUMODPO	Pacific Ocean	no upcharge	\$171
GRUMODL	Leaf	no upcharge	\$171
GRUMODLL	Lilac	no upcharge	\$171
GRUMODT	Tangerine	no upcharge	\$171
GRUMODSN	Starry Night	no upcharge	\$171
GRUMODSF	Seafoam	no upcharge	\$171

Standard TFM modesty color matches chassis color ordered, unless otherwise specified.

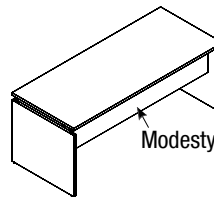
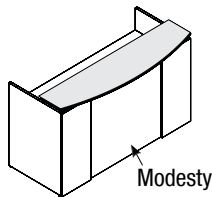

HPL Metallic Colors (15 DAYS)



HPL Bright Colors (20 DAYS)



Full Modesty Upgrade

Upgrade TFM 1/2 Modesty Panel to Full Modesty Panel (desks, credenzas, bridges)			
Model#	Description	Maverick Standard Colors	Price
GRFMTFM	Full Modesty Upgrade	TFM Colors	\$217
GRFMHPL	Full Modesty Upgrade	HPL Metallic & Bright Colors	\$388

Option for desk shell, credenza shell and bridges, for all TFM color options see page 196. Bright colors lead time 20 days.

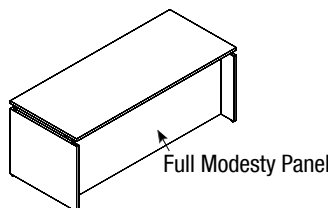

gravity series TFM color options (15 days)

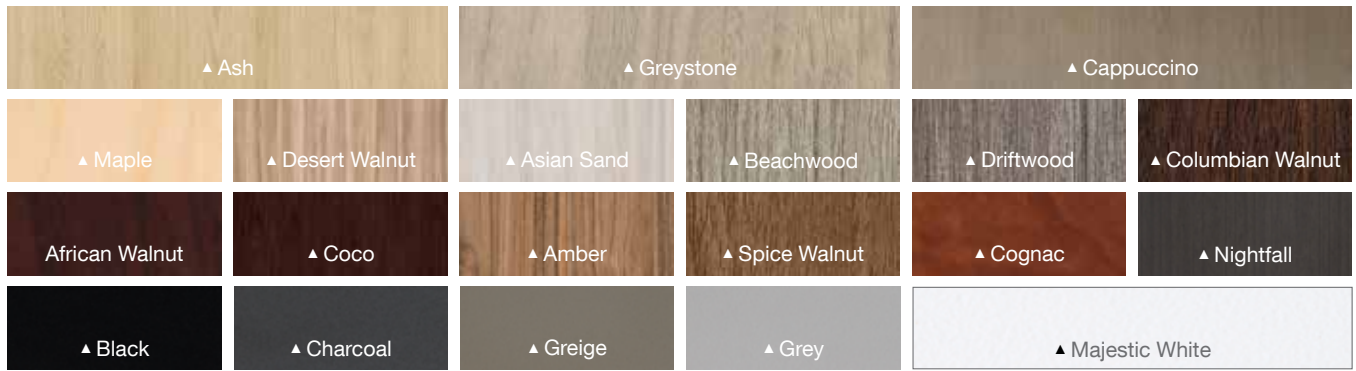

Colors shown with ▲ indicates standard availability of HPL Matte.

HPL Modesty & Privacy Panel Bright Color Options (20 days)



Anchorage 2335

Tackboard/Tackable Fabric Options (15 days)



Sunshine 2082 Red Delicious 2014 Aubergine 2036 Waterfall 2691 Green Apple 2087 Goose 2049 Onyx 2016

Cape Cod 3073

Tempest 2120 Metro 3077



Linen 7031 Surf 7062 Zebra 015 Skyscraper 022

Metallation 5118

Sprite 2671



Chrome 1676 Polished Pewter 1678 Snow 7040 Linen 7010

Phrase 9508



Maize 3010 Truffle 3050 Shale 3070 Sprout 3020 Marine 3030 Cayenne 3040 Poolside 3031

Metal Leg Color Options (15 days)

Metal Leg Bright Color Options (20 days)



Silver Black White Red Orange Dark Blue Light Blue

Markerboard Privacy Screens Color Options (20 days)



Silver White Blue Red Orange

All colors, fabrics and renderings are approximations. Metal colors are not a match to other colors. Colors may vary between factories.

TFM & HPL laminate finishes will vary.

For sample requests, email Maverick West: orderentry@maverickdesk.com. Maverick East: mveorders@maverickdesk.com.

For actual fabric samples, go to: guilfordofmaine.com/swatches

Color combination: Two colors may be specified at no charge. Contact design for additional options.