

apex series



Apex adapts to the activities of individuals and groups, creating a workplace that compels achievement. Available in our 20 standard colors.

Features

Modern, contemporary style. Standard grommets, face lock and handles on all pedestals.

Handle

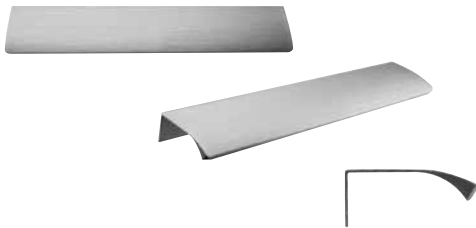

APH1
Smooth, curved edge handle in brushed aluminum
(Standard Apex handles)

Grommet

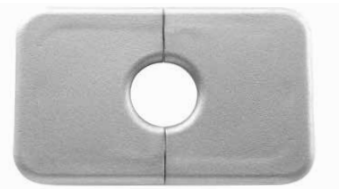

APRG1S
Standard Square Grommet - Silver

apex series

15 DAYS and **20** DAYS Lead Time

Product Specifications

Colors

- 20 standard colors are available. Two colors may be specified at no charge.
- See color chart for upcharge information.

Top / Worksurfaces

- 1" TFM (Thermally Fused Melamine) on industrial quality (45 lb.) particleboard.
- 2mm thermally-fused PVC edge banding.
- Woodgrain direction is horizontal for tops.

Chassis Construction

- TFM chassis fastened by screws, steel brackets, and/or concealed fasteners.
- Adjustable leveling glides are provided on all units.
- Apex Series shipped with temporary nail glides - remove at time of installation.
- Chassis are all ¾" material including low credenza and freestanding storage tower.

Drawer Interiors

- 9-ply Birch wood drawers

Drawer Suspension, Construction and Doors

- Drawers have full-extension, progressive-action slides with precision steel ball bearings.
- APH1 handles standard.
- Overlay drawer front and doors are standard on all separate storage units and separate file units.
- All file and lateral drawers file legal size from side to side and letter front to back.
- File drawer construction accommodates hanging files not stacked material on drawer bottom.
- Hutch doors overlay.

Cord Management

- A grommet is standard on all worksurfaces, silver or black.
- Grommet color will match feet color except white feet, which will take silver grommet.
- Optional wire management is available.

Locks

- Face locks standard on all support pedestals.
- Silver, removable cores are standard for all locks.
- Pedestal key numbers are randomly assigned to all locking pedestals.
- Key alike lock numbers (#101-115) may be specified at no charge.
- Master keys are available for purchase, Model# MM-MASTER KEY \$88 (Unlocks Maverick locks).
- Lock core & 1 set of keys, Model# MM-CORE-KEYS \$67 (Keys only ship with core).
- Core removal key, Model# MMREMOVAL KEY \$88.

Disclaimer: Dimensions assigned in this price list are nominal. If exact measurements are required, the requirement must be specified in the order and specifically acknowledged by Maverick. Maverick reserves the right to change construction details and standards without notification, if necessary.

Line drawings shown are resemblance to finish product. Product designs may vary. Colors may vary between factories.

How to Order Apex Series

WORKSURFACE UNITS: TOPS, BASES, SUPPORTS

1. Product number: **AP WT 24 72**
-
- Width
- Depth
- Product Type: Worksurface (Wedge)
- Series Name: Apex

2. Specify worksurface and chassis finish.
3. Specify drawer or door front finish (matching color edgeband only).
4. Specify data/power management. See page 155.

LOW CREDENZAS (P. 146–147)

- Available in a myriad of configurations to meet several storage considerations
- Specify **APSBL 2 0 7 2 L**

CUSHIONS (P. 154)

- Designed for low credenzas
- Specify **APCUH 2 0 3 0**

PRIVACY SCREENS (P. 143–144)

- TFM screens are mounted to worksurfaces.
- Specify **APPSUW 6 0**

WORKSURFACES (P. 135–137)

- Available in 20 colors
- Specify **APRECH 4 8 6 0**



SILVER GROMMET (APRG1S)



HANDLE (APH1)

WORKSURFACE SUPPORTS (P. 139–142)

- Worksurface support legs are ordered separately
- Required for supporting available Apex worksurfaces
- Specify **APODL 4 8**

apex series

Power Management

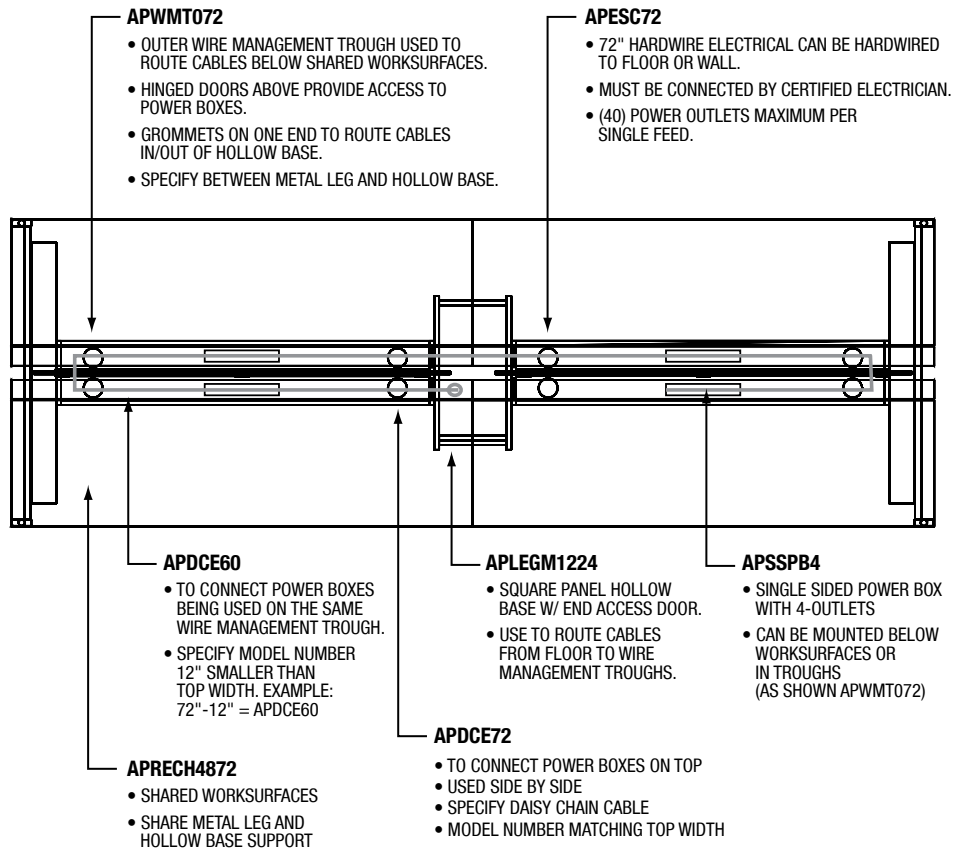

apex series

Statement of Line

WORKSURFACES

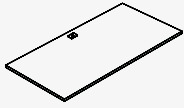

Rectangular
(APRT____)

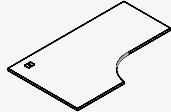

Extended Compu-Corner
(APET____)

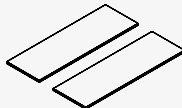

Rectangular Shared
(APRECH____)

WORKSURFACE SUPPORTS



External Stabilizer Bar
(APSB_)

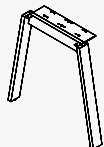

Apron Leg
(APOAL_)

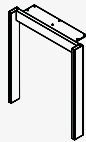

Double Post
(APODPL_)

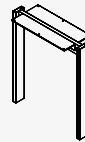

Shared Double Post Leg
(APDPM_)

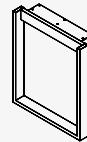

D-Leg
(APODL_)

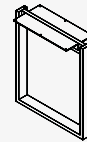

Shared D-Leg
(APMDL_)



28" Single Post
(APSP28)

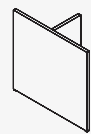

T-Leg
(APTLEG_)

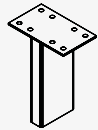

6" Single Post
(APSP6)

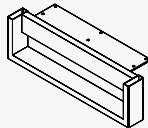

Short D-Leg
(APOS_)

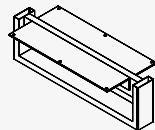

Short D-Leg (Shared)
(APMS_)

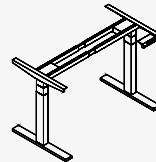

Adjustable Height Electrical Base
(MMLEGAHE_)

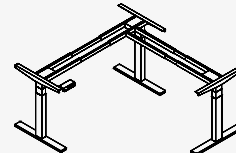

Adjustable Height Electrical Base
(MMLEGAHEL_)

SUPPORT PEDESTALS

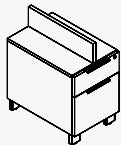

Box/File
(APPE_ BF)

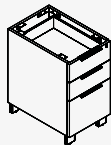

Box/Box/File
(APPE_ BBF)

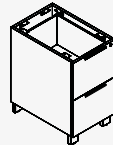

File/File
(APPE_ FF)

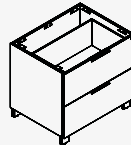

Lateral File
(APPE_ LF)

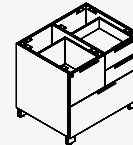

Personal Lateral File
(APPE_ PLF)

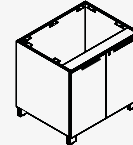

Hinged Door Cabinet
(APPE_ HDC)

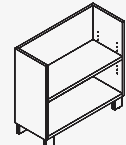

Bookcase Pedestal
(APPE_ BC)

LOW CREDENZAS

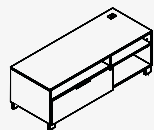

Single Lateral File
(APSL_)

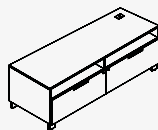

Double Lateral File
(APDL_)

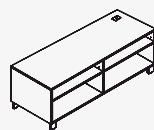

Open
(APDO_)

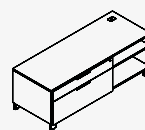

Single Box/Lateral
(APSL_)

apex series

Statement of Line

HUTCHES AND WALL MOUNT CABINETS

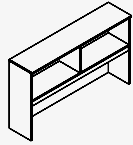

Open Hutch (No Doors)
(APH__ND)

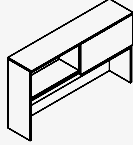

Hutch (One Sliding Door)
(APH__HS)

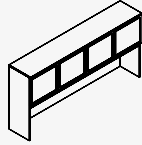

Hutch (Frosted Glass Doors)
(APH__WG)

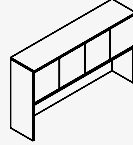

Hutch (Laminate Hinged Doors)
(APH__WD)

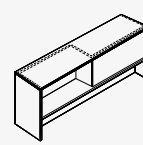

Hutch (Two-sided)
(APHSB__)

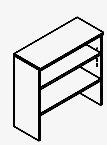

Bookcase Hutch
(APBCH)

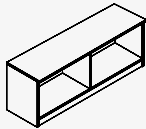

Wall Mount (Overhead)
No Doors
(APCFOHO__)

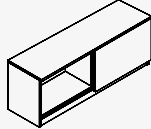

Wall Mount (Overhead)
One Sliding Door
(APCFOHS__)

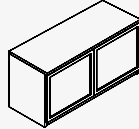

Wall Mount (Overhead)
Frosted Glass Doors
(APCFOHG__)

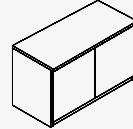

Wall Mount (Overhead)
Laminate Hinged Doors
(APCFOHD__)

FREESTANDING STORAGE

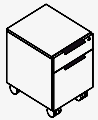

Pedestal
(APPED AX__BF)

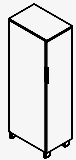

Single Cabinet
(APSTS_____)

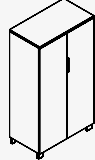

Double Cabinet
(APDST_____)

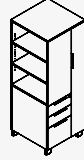

Personal Bookcase
(APPBSC_____)



Single (Box/Box/File)
(APBCV_____)

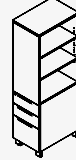

Personal Cabinet
(APBCPS_____)

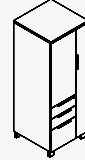

Personal Wardrobe
(APWCP_____)

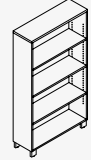

Bookcase
(APBC__)

PRIVACY SCREENS

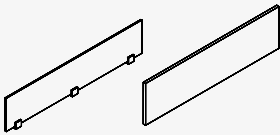

Frosted Acrylic Screen
(APPSU__)
TFM Privacy Screen
(APPSUW_____)

PRIVACY EXTENSIONS

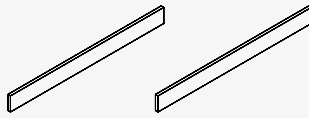

(TFM) Extension
(APPSUW_____)
(HPL) Extension
(APPSUHP_____)

MODESTIES

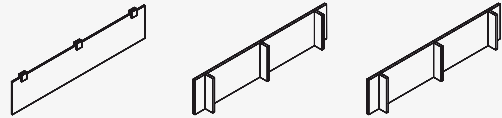

Frosted Acrylic Modesty
(APPSL__)
(TFM) Modesty
(APPSLW__)
(HPL) Modesty
(APPSLHP__)

TACKBOARDS AND CUSHIONS

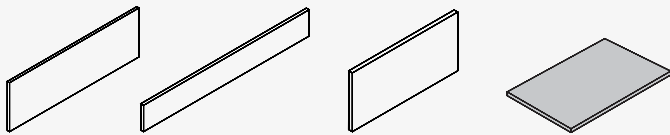

Tackboard
(APTKBD19__)
Tackboard (Lower)
(APTKBD08__)
Tackboard (Upper)
(APTKBD15__)
Cushion
(APCUH_____)

BASE

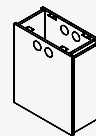

Square Panel (Hollow, End Access)
(APLEGM__)

apex series

Statement of Line

FREESTANDING TROUGHS

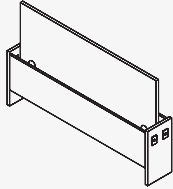

Trough with Center Panel

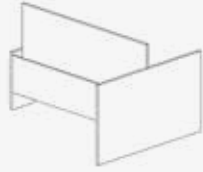

Trough with Center Panel & End Panel

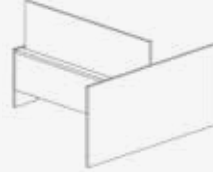

Trough with Doors, Center Panel & End Panel

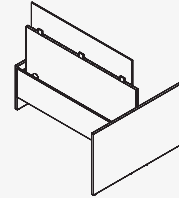

Trough with Center Panel, Privacy Screen & End Panel

CONFERENCE

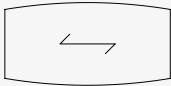

Boatshape
(APBS_...)

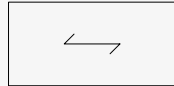

Rectangular
(APRE_...)

WIRE MANAGEMENT

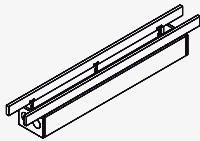

Middle Wire Management Trough
(APWMTM_...)

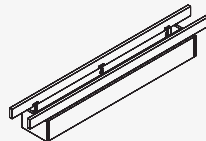

Outer Wire Management Trough
(APWMT0_...)

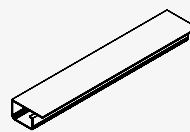

Plastic Wire Management Trough
(APPWM18)

DATA/POWER MANAGEMENT



Starter Cable
(APESC72)



Daisy Chain Cable
(APDCE_...)



Power Box (4 Outlet)
(APSSPB4)

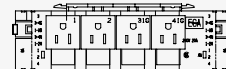

Power Box (8 Outlet)
(APSSPB8)

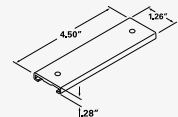

Vertibrate Wiring Module
(APSWM)



Grommet
(APRPG1GW)

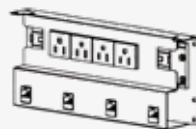

Power Module (4 Power, 4 RJ45)
(APBSB4)

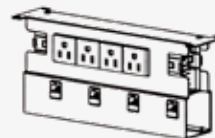

Power Module (8 Power, 4 RJ45)
(APSD8)



Tasklight
(APTKLTX24)

apex series

Configurations

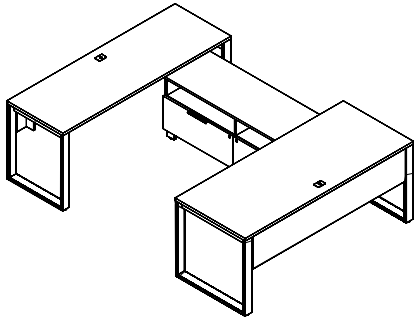

AP1L				
Qty	Model #	Description	List Price	Extended Price
1	APRT3072	Rectangular Top Worksurface	\$552	\$552
1	APRT2472	Rectangular Top Worksurface (24"x72")	\$495	\$495
2	APODL30	D-Leg (30"Dx28"H)	\$443	\$886
2	APODL24	D-Leg (24"Dx28"H)	\$416	\$832
2	APSB72	External Stabilizer Bar (56"W)	\$181	\$362
2	APPSLHP72	HPL Modesty Panel (12"Hx65"W)	\$355	\$710
1	APODL2061L	Low Double Lateral File Credenza, Left (20"Wx61"Dx22"H)	\$2,705	\$2,705
Total			\$6,542	

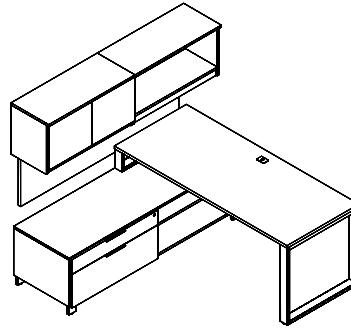

AP2L				
Qty	Model #	Description	List Price	Extended Price
1	APRT3072	Rectangular Top Worksurface (30"x72")	\$552	\$552
1	APODL30	D-Leg (30"Dx28"H)	\$443	\$443
1	APOS30	Short D-Leg (30"Dx6"H)	\$760	\$760
2	APSB72	External Stabilizer Bar (56"W)	\$181	\$362
1	APSBL2472L	Low Single Box/Lateral Credenza, Left (24"Dx72"Wx22"H)	\$2,705	\$2,705
1	APCFOHD36	Wall Mounted Overhead Cabinet with Hinged Doors	\$1,138	\$1,138
1	APCFOH036	Wall Mounted Overhead Cabinet with no Doors	\$899	\$899
1	APTAKBD1972	Tackboard (70"Wx19"H)	\$781	\$781
Total			\$7,640	

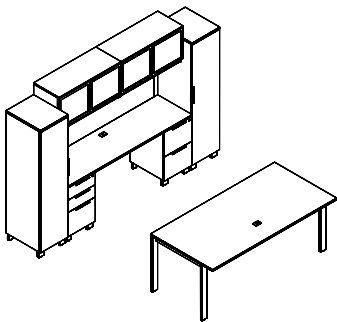

AP3				
Qty	Model #	Description	List Price	Extended Price
1	APRT3672	Rectangular Top Worksurface (36"Dx72"W)	\$601	\$601
1	APRT2072	Rectangular Top Worksurface (20"Dx72"W)	\$472	\$472
2	APODPL30	Double Post Leg (30"Dx28"H)	\$594	\$1,188
2	APSB72	External Stabilizer (56"W)	\$181	\$362
1	APPEDC20BBF	Supporting Box/Box/File, No Top (20"Dx16"Wx28"H)	\$1,566	\$1,566
1	APPEDD20FF	Supporting File/File, No Top (20"Dx16"Wx28"H)	\$1,481	\$1,481
2	APCFOHG36	Wall Mounted Overhead Cabinet with Frosted Glass Doors (14 3/4"Dx36"Wx18 1/2"H)	\$1,369	\$2,738
1	APTAKBD1972	Tackboard (70"Wx19"H)	\$781	\$781
1	APSTS2065L	Single Storage Cabinet, Left (20"Dx16"Wx65"H)	\$2,070	\$2,070
1	APSTS2065R	Single Storage Cabinet, Right (20"Dx16"Wx65"H)	\$2,070	\$2,070
Total			\$13,329	

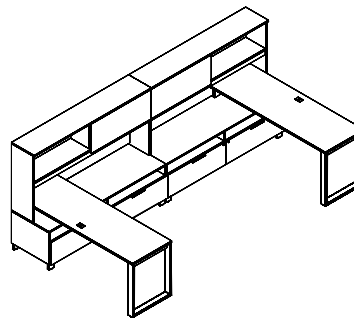

AP5				
Qty	Model #	Description	List Price	Extended Price
2	APRT2472	Rectangular Top Worksurface (24"x72")	\$495	\$990
2	APODL24	D-Leg (16"Dx28"H)	\$416	\$832
2	APTLEG2406	Support T-Leg TFM (16"Dx13"Wx6"H)	\$182	\$364
4	APSB72	External Stabilizer Bar (56"W)	\$181	\$724
1	APDOL2472L	Double Lateral File w/Open Shelf Credenza, Left (24"Dx72"Wx22"H)	\$2,912	\$2,912
1	APDOL2472R	Double Lateral File w/Open Shelf Credenza, Right (24"Dx72"Wx22"H)	\$2,912	\$2,912
2	APH72SD	Hutch w/One Sliding Door (14"Dx72"Wx36"H)	\$1,640	\$3,280
2	APTAKBD1972	Hutch Tackboard (1"Dx70"Wx19"H)	\$781	\$1,562
Total			\$13,576	

Configurations must be ordered as shown.

apex series

Configurations

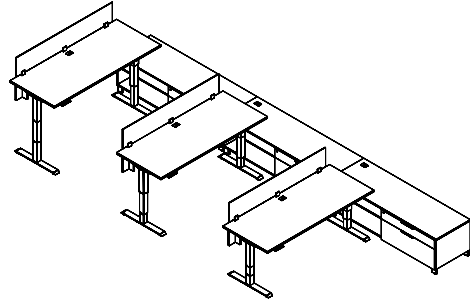
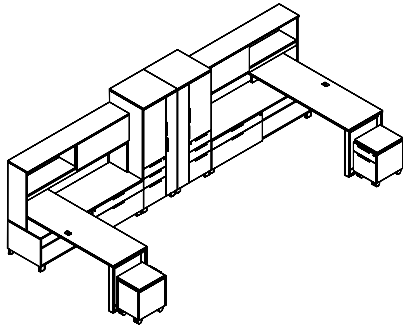

AP6					
Qty	Model #	Description	List Price	Extended Price	
2	APRT2472	Rectangular Top Worksurface (24"x72")	\$495	\$990	
2	APODL24	D-Leg (16"Dx28"H)	\$416	\$832	
2	APTLEG2406	Support T-Leg TFM (16"Dx13"Wx6"H)	\$182	\$364	
4	APSB72	External Stabilizer Bar (56"W)	\$181	\$724	
1	APSBL2472L	Single Box/Lateral Credenza, Left (24"Dx72"Wx22"H)	\$2,705	\$2,705	
1	APSBL2472R	Single Box/Lateral Credenza, Right (24"Dx72"Wx22"H)	\$2,705	\$2,705	
2	APH72SD	Hutch w/ One Sliding Door (14"Dx72"Wx36"H)	\$1,640	\$3,280	
2	APTkbd1972	Hutch Tackboard (1"Dx70"Wx19"H)	\$781	\$1,562	
2	APPEDAX20BF	Mobile Box/File Pedestal (19"Dx16"Wx22"H)	\$1,249	\$2,498	
2	APCUH2016	Pedestal Cushion (19"Dx16"W)	\$330	\$660	
1	APWCP2465R	Personal Wardrobe w/ Storage Cabinet, Right (24"Dx24"Wx65"H)	\$2,474	\$2,474	
1	APWCP2465L	Personal Wardrobe w/ Storage Cabinet, Left (24"Dx24"Wx65"H)	\$2,474	\$2,474	
Total				\$21,268	

AP7R					
Qty	Model #	Description	List Price	Extended Price	
3	APRT3072	Rectangular Top Worksurface (30"Dx72"W)	\$552	\$1,656	
3	MMLEGAHE30S	Adjustable Height Electrical Legs (24/30"Dx72"Wx23-48"H) Silver	\$1,498	\$4,494	
3	APPSU72	Frosted Acrylic Privacy Screen (65"Wx12"Hx1"D)	\$844	\$2,532	
3	APPSLHP72	HPL Modesty Panel (65"Wx12"H)	\$355	\$1,065	
3	APSBL2472R	Single Box/Lateral Credenza, Right (24"Dx72"Wx22"H)	\$2,705	\$8,115	
			Total	\$17,862	

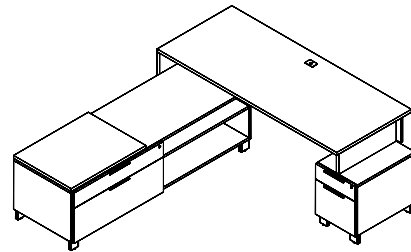
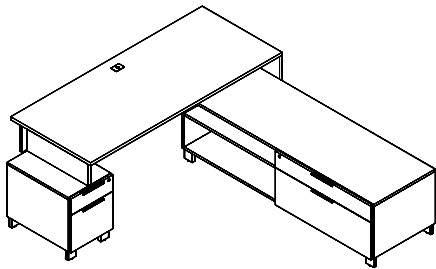

AP8R					
Qty	Model #	Description	List Price	Extended Price	
1	APRT3072	Rectangular Top Worksurface (30"Dx72"W)	\$552	\$552	
1	APPEDA24BF	Supporting Box/File Pedestal (24"Dx16"Wx28"H)	\$1,498	\$1,498	
1	APTLEG30	T-Leg (30"Dx12"Wx28"H)	\$215	\$215	
1	APSB72	External Stabilizer Bar (65")	\$181	\$181	
1	APPSLHP72	HPL Modesty Panel (65"Wx12"H)	\$355	\$355	
1	APSBL2472R	Single Box/Lateral Credenza, Right (24"Dx72"Wx22"H)	\$2,705	\$2,705	
Total				\$5,506	

AP9L					
Qty	Model #	Description	List Price	Extended Price	
1	APRT3072	Rectangular Top Worksurface (30"Dx72"W)	\$552	\$552	
1	APPEDA24BF	Supporting Box/File Pedestal (24"Dx16"Wx28"H)	\$1,498	\$1,498	
1	APTLEG30	T-Leg (30"Dx12"Wx28"H)	\$215	\$215	
1	APSB72	External Stabilizer Bar (65"W)	\$181	\$181	
1	APPSLHP72	HPL Modesty Panel (65"Wx12"H)	\$355	\$355	
1	APSBL2472L	Single Box/Lateral Credenza, Left (24"Dx72"Wx22"H)	\$2,705	\$2,705	
1	APCUH2430	Credenza Cushion (23"Dx30"W)	\$398	\$398	
			Total	\$5,904	

Configurations must be ordered as shown.

apex series

Configurations

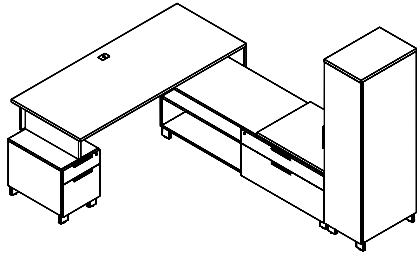

AP10R						
Qty	Model #	Description	List Price	Extended Price		
1	APRT3072	Rectangular Top Worksurface (30"Dx72"W)	\$552	\$552		
1	APPEDA24BF	Supporting Box/File Pedestal (24"Dx16"Wx28"H)	\$1,498	\$1,498		
1	APTLEG30	T-Leg (30"Dx12"Wx28"H)	\$215	\$215		
2	APSB72	External Stabilizer Bar (65"W)	\$181	\$362		
1	APPSL72	Frosted Acrylic Modesty (65"Wx12"H)	\$844	\$844		
1	APSBL2472R	Single Box/Lateral Credenza, Right (24"Dx72"Wx22"H)	\$2,705	\$2,705		
1	APCUH2430	Credenza Cushion (23"Dx30"W)	\$398	\$398		
1	APSTS2465R	Single Storage Cabinet, Right (24"Dx16"Wx65"H)	\$2,188	\$2,188		
Total				\$8,762		

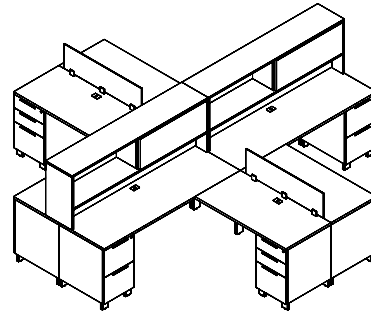

AP12						
Qty	Model #	Description	List Price	Extended Price		
4	APRT2472	Rectangular Top Worksurface (24"Dx72"W)	\$495	\$1,980		
2	APHSB72	Two-sided Hutch, Shared Bins (14"Dx36"Hx72"W)	\$1,312	\$2,624		
4	APRT2448	Rectangular Top Worksurface (24"Dx48"W)	\$333	\$1,332		
2	APDPML24	Shared Double Post Leg (24"Dx28"H)	\$691	\$1,382		
4	APPEDC24BBF	Supporting Box/Box/File Pedestal (24"Dx16"Wx28"H)	\$1,577	\$6,308		
4	APPEDD24FF	Supporting File/File Pedestal (24"Dx16"Wx28"H)	\$1,509	\$6,036		
4	APSB60	External Stabilizer Bar (44"W)	\$155	\$620		
2	APPSU48	Frosted Acrylic Privacy Screen (41"Wx12"H)	\$574	\$1,148		
4	APTKBD0872	Lower Tackboard (70"Wx8"H)	\$523	\$2,092		
4	APTKBD1536	Upper Tackboard (35"Wx15"H)	\$476	\$1,904		
4	APGANG1	Ganging Hardware (4"Dx6"Wx25"H)	\$54	\$216		
Total				\$25,642		

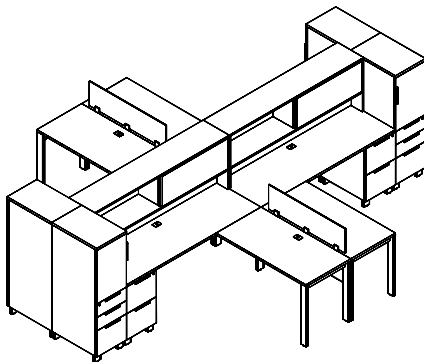

AP13						
Qty	Model #	Description	List Price	Extended Price		
4	APRT2472	Rectangular Top Worksurface (24"Dx72"W)	\$495	\$1,980		
4	APRT2448	Rectangular Top Worksurface (24"Dx48"W)	\$333	\$1,332		
4	APODPL24	Double Post Leg (24"Dx28"H)	\$555	\$2,220		
2	APDPML24	Shared Double Post Leg (24"Dx28"H)	\$691	\$1,382		
4	APPEDD24FF	Supporting File/File Pedestal (24"Dx16"Wx28"H)	\$1,509	\$6,036		
4	APSB60	External Stabilizer Bar (44"W)	\$155	\$620		
2	APPSU48	Frosted Acrylic Privacy Screen (41"Wx12"H)	\$574	\$1,148		
2	APBCV2454L	Single Storage Box/Box/File Upper Door, Left (24"Dx16"Wx54"H)	\$2,474	\$4,948		
2	APBCV2454R	Single Storage Box/Box/File Upper Door, Right (24"Dx16"Wx54"H)	\$2,474	\$4,948		
2	APHSB72	Two-sided Hutch w/ Shared Bins (14"Dx72"Wx25"H)	\$1,312	\$2,624		
4	APTKBD0872	Lower Tackboard (70"Wx8"H)	\$523	\$2,092		
4	APTKBD1536	Upper Tackboard (35"Wx15"H)	\$476	\$1,904		
4	APGANG1	Ganging Hardware (4"Dx6"Wx25"H)	\$54	\$216		
Total				\$31,450		

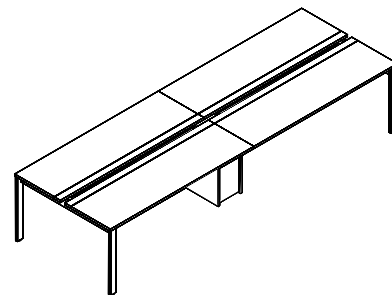

AP14						
Qty	Model #	Description	List Price	Extended Price		
2	APRECH4872	Shared Rectangular Top Worksurface (48"Dx72"W)	\$987	\$1,974		
2	APODPL48	Double Post Leg (48"Dx28"H)	\$733	\$1,466		
2	APWMT072	Outer Wire Management Trough (59"Wx8"Hx10"D)	\$1,162	\$2,324		
4	APSB72	External Stabilizer Bar (56"W)	\$181	\$724		
1	APLEGM1224	Square Panel Base Hollow, w/ End Access Door (12"Dx24"W)	\$605	\$605		
1	APESC72	Electrical Starter Cable (72")	\$296	\$296		
4	APSSPB4	Single Sided Power Box w/ 4 Power Outlets	\$231	\$924		
2	APDCE60	52" Daisy Chain Electrical Cable	\$296	\$592		
1	APDCE72	64" Daisy Chain Electrical Cable	\$328	\$328		
2	APGANG1	Ganging Hardware (4"Dx6"Wx25"H)	\$54	\$108		
Total				\$9,341		

Configurations must be ordered as shown.

apex series

Configurations

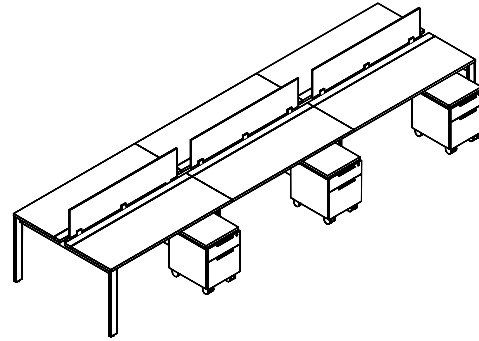
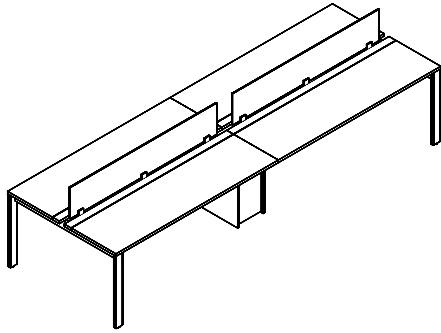

AP15

Qty	Model #	Description	List Price	Extended Price
2	APRECH4872	Rectangular (Shared) Worksurface (48"Dx72"W)	\$987	\$1,974
2	APODPL48	Double Post Leg (48"Dx28"H)	\$733	\$1,466
2	APWMT072	Outer Wire Management Trough (59"Wx8"Hx10"D)	\$1,162	\$2,324
4	APSB72	External Stabilizer Bar (56"W)	\$181	\$724
1	APLEGM1224	Square Panel Base Hollow, w/ End Access Door (12"Dx24"W)	\$605	\$605
2	APPSU72	Frosted Acrylic Privacy Screen (65"Wx12"H)	\$844	\$1,688
1	APESC72	Electrical Starter Cable (72")	\$296	\$296
4	APSSPB4	Single Sided Power Box w/ 4 Power Outlets	\$231	\$924
2	APDCE60	52" Daisy Chain Electrical Cable	\$296	\$592
1	APDCE72	64" Daisy Chain Electrical Cable	\$328	\$328
2	APGANG1	Ganging Hardware (4"Dx6"Wx25"H)	\$54	\$108
Total			\$11,029	

AP16

Qty	Model #	Description	List Price	Extended Price
3	APRECH4860	Rectangular (Shared) Worksurface (48"Dx60"W)	\$885	\$2,655
2	APODPL48	Double Post Leg (48"Dx28"H)	\$733	\$1,466
1	APWMTM60	Middle Wire Management Trough (48"Wx8"Hx10"D)	\$940	\$940
2	APWMT060	Outer Wire Management Trough (47"Wx8"Hx10"D)	\$922	\$1,844
6	APSB60	External Stabilizer Bar (44"W)	\$155	\$930
2	APLEGM1224	Square Panel Base Hollow, w/ End Access Door (12"Dx24"W)	\$605	\$1,210
3	APPSU60	Frosted Acrylic Privacy Screen (53"Wx12"H)	\$829	\$2,487
6	APPEDAX20BF	Mobile Box/File Pedestal (19"Dx16"Wx22"H)	\$1,249	\$7,494
1	APESC72	Electrical Starter Cable (72")	\$296	\$296
6	APSSPB4	Single Sided Power Box w/ 4 Power Outlets	\$231	\$1,386
2	APDCE48	40" Daisy Chain Electrical Cable	\$266	\$532
3	APDCE60	52" Daisy Chain Electrical Cable	\$296	\$888
4	APGANG1	Ganging Hardware (4"Dx6"Wx25"H)	\$54	\$216
Total			\$22,344	

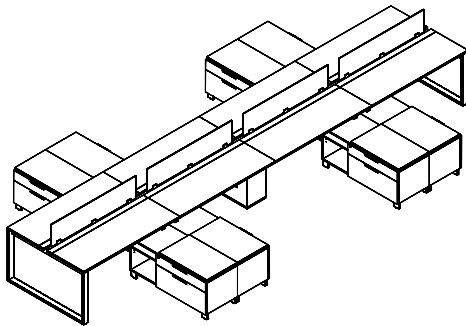

AP17

Qty	Model #	Description	List Price	Extended Price
4	APRECH4860	Rectangular (Shared) Worksurface (48"Dx60"W)	\$885	\$3,540
2	APODL48	D-Leg (48"Dx28"H)	\$849	\$1,698
2	APWMT060	Outer Wire Management Trough (47"Wx8"Hx10"D)	\$922	\$1,844
2	APWMTM60	Middle Wire Management Trough (48"Wx8"Hx10"D)	\$940	\$1,880
8	APSB60	External Stabilizer Bar (44"W)	\$155	\$1,240
3	APLEGM1224	Square Panel Base Hollow, w/ End Access Door (12"Dx24"W)	\$605	\$1,815
4	APPSU60	Frosted Acrylic Privacy Screen (53"Wx12"H)	\$829	\$3,316
4	APSBL2048R	Single Box/Lateral Credenza, Right (20"Dx48"Wx22"H)	\$2,317	\$9,268
4	APSBL2048L	Single Box/Lateral Credenza, Left (20"Dx48"Wx22"H)	\$2,317	\$9,268
8	APCUH2030	Low Credenza Cushion (19"Dx30"Wx1"H)	\$375	\$3,000
1	APESC72	Electrical Starter Cable (72")	\$296	\$296
8	APSSPB4	Single Sided Power Box w/ 4 Power Outlets	\$231	\$1,848
2	APDCE48	40" Daisy Chain Electrical Cable	\$266	\$532
5	APDCE60	52" Daisy Chain Electrical Cable	\$296	\$1,480
6	APGANG1	Ganging Hardware (4"Dx6"Wx25"H)	\$54	\$324
Total			\$41,349	

Configurations must be ordered as shown.

apex series

Configurations

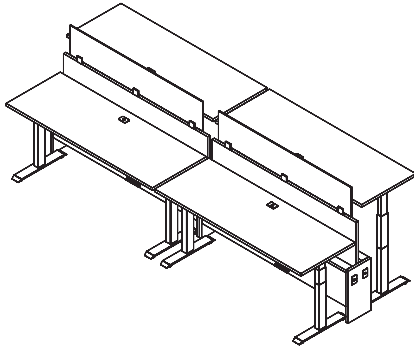

AP18				
Qty	Model #	Description	List Price	Extended Price
4	APRT2465	Rectangular Top Worksurface, Silver Sq Grom Ctr (24"D x 65"W x 1")	\$472	\$1,888
4	MMLEGAHE24S3	Silver Electrical Height Adjustable Base (For 24"D Top)	\$1,498	\$5,992
2	APWMT6636WDPS	Trough with Hinged Doors, Ctr Panel 36"H, Privacy Screen - APPSU66 (10"D x 66"W x 36"H)	\$2,180	\$4,360
1	APESC72	Electrical Starter Cable 72"W (8 Wire, 4 Circuit)	\$296	\$296
4	APSSPB4	Single Sided Power Box with 4 Power Outlet	\$231	\$924
2	APDCE66	58"W Daisy Chain Electrical Cable (For 66"W Trough)	\$317	\$634
1	APDCE60	46"W Daisy Chain Electrical Cable (For 54"W Trough)	\$296	\$296
Total			\$14,390	

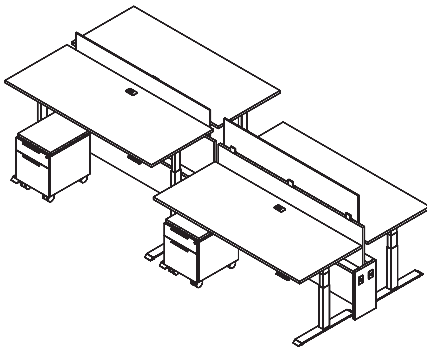

AP19				
Qty	Model #	Description	List Price	Extended Price
4	APRT3071	Rectangular Top Worksurface (30"D x 71"W x 1")	\$552	\$2,208
4	MMLEGAHE30S3	Silver Electrical Height Adjustable Base (For 30"D Top)	\$1,498	\$5,992
2	APWMT7236WDPS	Trough with Hinged Doors, Ctr Panel 36"H, Privacy Screen - APPSU72 (10"D x 72"W x 36"H)	\$2,231	\$4,462
4	APPEDAX20BF	Mobile Box/File Pedestal Face Lock, APH1 (20"D x 16"W x 22"H)	\$1,249	\$4,996
4	APCUH2016	Mobile Pedestal Cushion (19"D x 16"W x 1"H)	\$330	\$1,320
1	APESC72	Electrical Starter Cable 72"W (8 Wire, 4 Circuit)	\$296	\$296
4	APSSPB4	Single Sided Power Box with 4 Power Outlets	\$231	\$924
2	APDCE72	64"W Daisy Chain Electrical Cable (For 72"W Trough)	\$328	\$656
1	APDCE60	52"W Daisy Chain Electrical Cable (For 60"W Trough)	\$296	\$296
4	APRPG1S	Silver Rectangular Power Grommet (1 PWR, 2 USB) Ctr Top APRT3071	\$588	\$2,352
Total			\$23,502	

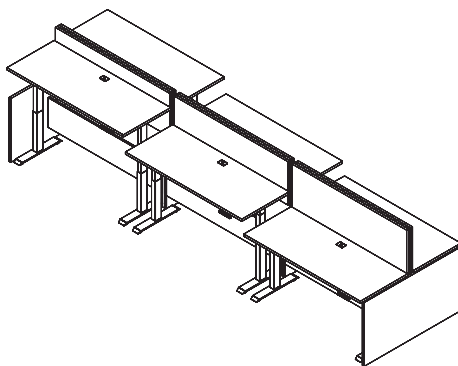

AP20				
Qty	Model #	Description	List Price	Extended Price
6	APRT2459	Rectangular Top Worksurface, Silver Sq Grom Ctr (24"D x 59"W x 1")	\$441	\$2,646
6	MMLEGAHE24S3	Silver Electrical Height Adjustable Base (For 24"D Top)	\$1,498	\$8,988
1	APWMT6048ND	Trough No Doors, Center End Panel 48"H (10"D x 66"W x 48"H)	\$1,064	\$1,064
2	APWMT6048ND48	Trough No Doors, Center End Panel 48"W & End Panel (10"D x 66"W x 48"H)	\$1,317	\$2,634
6	APTKBD1960	Tackboard (58"W x 19"H) For 60"W Trough	\$683	\$4,098
1	APESC72	Electrical Starter Cable 72"W (8 Wire, 4 Circuit)	\$296	\$296
6	APSSPB4	Single Sided Power Box with 4 Power Outlets	\$231	\$1,386
4	APDCE60	52"W Daisy Chain Electrical Cable (For 60"W Trough)	\$296	\$1,184
1	APDCE48	40"W Daisy Chain Electrical Cable (For 48"W Trough)	\$266	\$266
Total			\$22,562	

Configurations must be ordered as shown.

apex series

Configurations

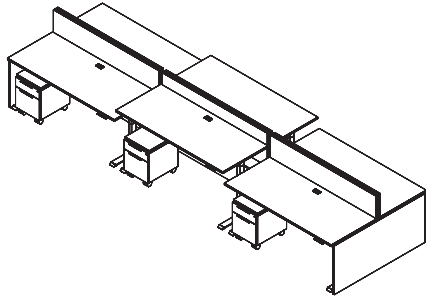

AP21

Qty	Model #	Description	List Price	Extended Price
6	APRT3071	Rectangular Top Worksurface, Silver Sq Grom Ctr (30"D x 71"W x 1")	\$552	\$3,312
6	MMLEGAHE30S3	Silver Electrical Height Adjustable Base (For 30"D Top)	\$1,498	\$8,988
1	APWMT7242ND	Trough No Doors with Center Panel 48"H (10"D x 72"W x 42"H)	\$1,120	\$1,120
2	APWMT7242ND60	Trough No Doors with Center Panel 42"H & 60"W End Panel (10"D x 72"W x 42"H)	\$1,421	\$2,842
6	APTKBD1972	Tackboard (70"W x 19"H) For 72"W Trough	\$781	\$4,686
6	APPEDAX20BF	Mobile Box/File Pedestal Face Lock, APH1 Handles (20"D x 16"W x 22"H)	\$1,249	\$7,494
6	APCUH2016	Mobile Pedestal Cushion (19"D x 16"W x 1"H)	\$330	\$1,980
1	APESC72	Electrical Starter Cable 72"W (8 Wire, 4 Circuit)	\$296	\$296
6	APSSPB4	Single Sided Power Box with 4 Power Outlets	\$231	\$1,386
4	APDCE72	64"W Daisy Chain Electrical Cable	\$328	\$1,312
1	APDCE60	52"W Daisy Chain Electrical Cable	\$296	\$296
6	APRPG1S	Silver Rectangular Power Grommet (1 PWR, 2 USB) Ctr Top APRT 3071	\$588	\$3,528
Total			\$37,240	

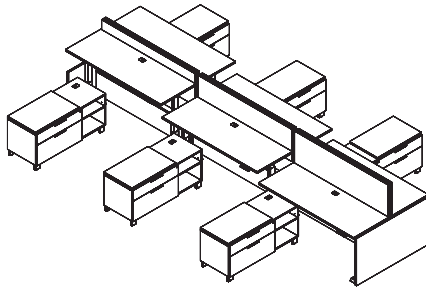

AP22

Qty	Model #	Description	List Price	Extended Price
6	APRT2465	Rectangular Top Worksurface, Silver Sq Grom Ctr (24"D x 65"W x 1")	\$472	\$2,832
6	MMLEGAHE24S3	Silver Electrical Height Adjustable Base (For 24"D Top)	\$1,498	\$8,988
1	APWMT6648WD	Trough with Hinged Doors, Ctr Panel 48"H (10"D x 66"W x 48"H)	\$1,470	\$1,470
2	APWMT6648WD48	Trough with Hinged Doors, Ctr Panel 48"H & 48"W End Panel (10"D x 66"W x 48"H)	\$1,722	\$3,444
6	APTKBD1966	Tackboard (64"W x 19"H) for 66"W Trough	\$733	\$4,398
3	APSBL2048L	Single Box/Lateral Credenza, Left (20"D x 48"W x 22"H)	\$2,317	\$6,951
3	APSBL2048R	Single Box/Lateral Credenza, Right (20"D x 48"W x 22"H)	\$2,317	\$6,951
6	APCUH2030	Credenza Cushion (19"D x 30"W x 1 "H)	\$375	\$2,250
1	APESC72	Electrical Starter Cable 72"W (8 Wire, 4 Circuit)	\$296	\$296
6	APSSPB4	Single Sided Power Box with 4 Power Outlets	\$231	\$1,386
4	APDCE66	58"W Daisy Chain Electrical Cable (For 66"W Trough)	\$317	\$1,268
1	APDCE54	46"W Daisy Chain Electrical Cable (For 66"W Trough)	\$296	\$296
Total			\$40,530	

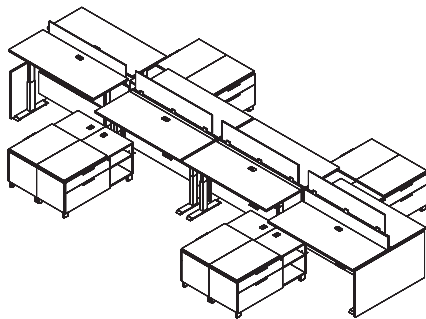

AP23

Qty	Model #	Description	List Price	Extended Price
8	APRT2459	Rectangular Top Worksurface, Silver Sq Grom Ctr (24"D x 59"W x 1")	\$441	\$3,528
8	MMLEGAHE24S3	Silver Electrical Height Adjustable Base (For 24"D Top)	\$1,498	\$11,984
2	APWMT6036NDPS	Trough No Doors with Ctr Panel 36"H, Privacy Screen APPSU60 (10"D x 60"W x 36"H)	\$1,774	\$3,548
2	APWMT6036WD48PS	Trough No Doors with Ctr Panel 36"H & 48"W End Panel, Privacy Screen - APPSU60 (10"D x 60"W x 36"H)	\$2,378	\$4,756
4	APSBL2048L	Single Box/ Lateral Credenza, Left (20"D x 48"W x 22"H)	\$2,317	\$9,268
4	APSBL2048R	Single Box/ Lateral Credenza, Right (20"D x 48"W x 22"H)	\$2,317	\$9,268
8	APCUH2030	Credenza Cushion (19"D x 30"W x 1 "H)	\$375	\$3,000
1	APESC72	Cable 72"W (8 Wire, 4 Circuit)	\$296	\$296
8	APSSPB4	Single Sided Power Box with 4 Power Outlets	\$231	\$1,848
6	APDCE66	52"W Daisy Chain Electrical Cable (For 60"W Trough)	\$317	\$1,902
1	APDCE48	40"W Daisy Chain Electrical Cable (For 48"W Trough)	\$266	\$266
8	APRPG1S	Silver Rectangular Power Grommet (1 PWR, 2 USB) Ctr top APRT 2459	\$588	\$4,704
Total			\$54,368	

Configurations must be ordered as shown.

Worksurfaces

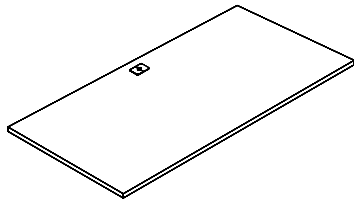

Rectangular Worksurface

Model#	Depth	Width	Height	Weight	Cube	Price
APRT2030	20"	30"	1"	16	1	\$271
APRT2031	20"	31"	1"	17	1	\$271
APRT2036	20"	36"	1"	19	1	\$280
APRT2042	20"	42"	1"	22	1	\$292
APRT2048	20"	48"	1"	25	1	\$315
APRT2054	20"	54"	1"	29	1	\$369
* APRT2060	20"	60"	1"	32	1	\$413
APRT2062	20"	62"	1"	33	1	\$422
* APRT2066	20"	66"	1"	35	1	\$460
* APRT2072	20"	72"	1"	38	1	\$472
APRT2430	24"	30"	1"	19	1	\$287
APRT2431	24"	31"	1"	20	1	\$287
15 APRT2436	24"	36"	1"	23	1	\$296
15 APRT2442	24"	42"	1"	27	1	\$319
15 APRT2448	24"	48"	1"	30	1	\$333
15 APRT2454	24"	54"	1"	34	1	\$422
15 * APRT2460	24"	60"	1"	38	1	\$441
APRT2462	24"	62"	1"	39	1	\$445
15 * APRT2466	24"	66"	1"	42	1	\$472
15 * APRT2472	24"	72"	1"	45	1	\$495
APRT3048	30"	48"	1"	38	1	\$365
APRT3054	30"	54"	1"	43	1	\$472
15 * APRT3060	30"	60"	1"	47	2	\$486
* APRT3066	30"	66"	1"	52	2	\$525
15 * APRT3072	30"	72"	1"	57	2	\$552
* APRT3660	36"	60"	1"	57	2	\$531
* APRT3666	36"	66"	1"	62	2	\$574
* APRT3672	36"	72"	1"	68	2	\$601

1 Silver square grommet (top center) standard.
 Grommet on 20", 24" & 30"D is 3" clear from approach. On 36"D, it is 9" clear from approach.
 Depending on support configuration, external stabilizer may be required on tops of 54" or greater.
 See external stabilizer bar selection guide on page 139.

* 2 Stabilizer bars are required on 60", 66" & 72" wide worksurfaces when supporting with left & right double post leg, D-legs or T-legs.

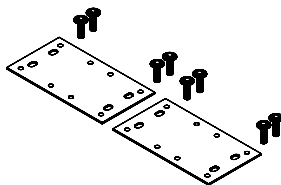

Connecting Hardware (Brackets & Bolts)

Model#	Depth	Width	Height	Weight	Cube	Price
15 APGANG1	4"	6"	1/4"	2	1	\$54
15 APGANG2	4"	6"	1/4"	3	1	\$108

NOTE: Must be field installed.

* If using as a return top, specify APGANG1 (2 brackets & 8 bolts 8x1" supplied).
 * If using as a bridge top, specify APGANG2 (4 brackets & 16 bolts 8x1" supplied).

Worksurfaces

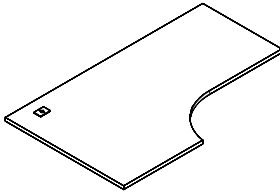

Extended Compu-Corner Worksurface, Left Return

Model#	(L)	(B)	(E)	(K)	(R)	(W)	Weight	Cube	Price
* APET243660L	60"	36"	24"	21"	24"	22"	57	2	\$587
* APET243666L	66"	36"	24"	21"	24"	24"	62	2	\$622
* APET243672L	72"	36"	24"	21"	24"	30"	68	2	\$644
* APET244260L	60"	42"	24"	24"	24"	21"	66	2	\$627
* APET244266L	66"	42"	24"	24"	24"	27"	73	2	\$666
* APET244272L	72"	42"	24"	24"	24"	33"	79	2	\$684

1 Silver square grommet (top corner) standard. 3" Clear from approach.

See external stabilizer bar selection guide on page 139.

* 2 Stabilizer bars are required on 60", 66" & 72" wide worksurfaces when supporting with left & right double post leg, D-legs or T-legs.

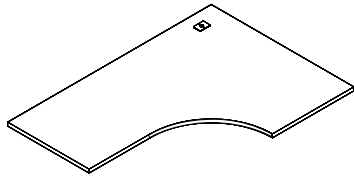

Extended Compu-Corner Worksurface, Right Return

Model#	(L)	(B)	(E)	(K)	(R)	(W)	Weight	Cube	Price
* APET243660R	60"	36"	24"	21"	24"	22"	57	2	\$587
* APET243666R	66"	36"	24"	21"	24"	24"	62	2	\$622
* APET243672R	72"	36"	24"	21"	24"	30"	68	2	\$644
* APET244260R	60"	42"	24"	24"	24"	21"	66	2	\$627
* APET244266R	66"	42"	24"	24"	24"	27"	72	2	\$666
* APET244272R	72"	42"	24"	24"	24"	33"	79	2	\$684

1 Silver square grommet (top corner) standard. 3" Clear from approach.

See external stabilizer bar selection guide on page 139.

* 2 Stabilizer bars are required on 60", 66" & 72" wide worksurfaces when supporting with left & right double post leg, D-legs or T-legs.

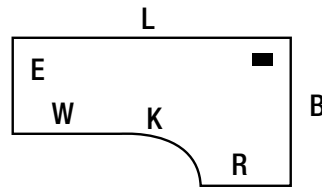

apex series

Worksurfaces

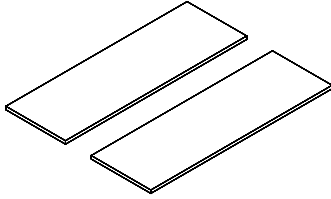

Two Rectangular Worksurfaces for Shared Supports

Model#	Depth	Width	Height	Weight	Cube	Price
APRECH4848	48"	48"	1"	50	2	\$669
15 APRECH4860	48"	60"	1"	63	2	\$885
APRECH4866	48"	66"	1"	69	2	\$944
15 APRECH4872	48"	72"	1"	75	2	\$987
APRECH6048	60"	48"	1"	65	2	\$733
APRECH6060	60"	60"	1"	82	3	\$970
APRECH6066	60"	66"	1"	90	3	\$1,052
APRECH6072	60"	72"	1"	98	3	\$1,103

* To be used with middle troughs, see page 154. 2 Stabilizers are required on tops of 54" or greater. See external stabilizer bar selection guide on page 139.

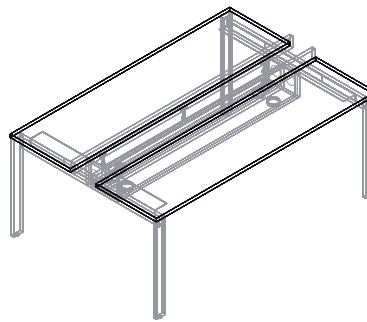

Worksurfaces for Support Pedestals

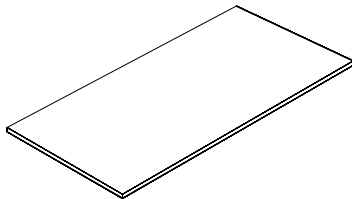

Rectangular Worksurface, Tops for Supporting Pedestals

Model#	Depth	Width	Height	Fits Pedestal	Weight	Cube	Price
APTOP2016	20"	16"	1"	BBF, FF	9	1	\$183
APTOP2416	24"	16"	1"	BBF, FF	9	1	\$183
APTOP3016	30"	16"	1"	BBF, FF	13	1	\$183
APTOP2030	20"	30"	1"	HDC	16	1	\$271
APTOP2031	20"	31"	1"	LF, PLF	17	1	\$271
APTOP2430	24"	30"	1"	HDC	16	1	\$287
APTOP2431	24"	31"	1"	LF, PLF	20	1	\$296
15 APTOP2036	20"	36"	1"	LF, HDC	19	1	\$280
15 APTOP2436	24"	36"	1"	LF, HDC	23	1	\$296
APTOP2062	20"	62"	1"	2 LF, 2 PLF	33	1	\$422
APTOP2462	24"	62"	1"	2 LF, 2 PLF	39	1	\$445
15 APTOP2072	20"	72"	1"	2 LF, 2 HDC	45	1	\$472
15 APTOP2472	24"	72"	1"	2 LF, 2 HDC	45	1	\$495

* Tops ship separately for field install, brackets are included. Tops only can be purchase for own use.

apex series

Support Pedestals

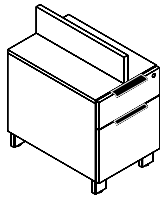

Supporting Box/File with Top Center Support (Face lock, APH1 handles)

Model#	Depth	Width	Height	Weight	Cube	Price
APPEDA20BF	20"	16"	28"	73	6	\$1,463
APPEDA24BF	24"	16"	28"	78	7	\$1,498
APPEDA30BF	30"	16"	28"	89	8	\$1,535

Top support to be installed flush with tops.
For flush pedestal with top specify location, add MMCUT3 \$234.

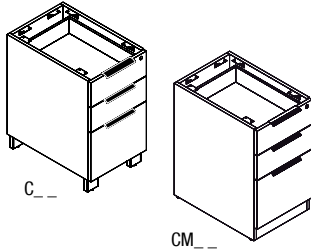

Supporting Box/Box/File, No Top (Face lock, APH1 handles)

Model#	Depth	Width	Height	Weight	Cube	Price
15 APPEDC20BBF	20"	16"	28"	77	6	\$1,566
15 APPEDC24BBF	24"	16"	28"	83	7	\$1,577
15 APPEDC30BBF	30"	16"	28"	92	8	\$1,616
15 APPEDCM20BBF	20"	16"	28"	77	6	\$1,029
15 APPEDCM24BBF	24"	16"	28"	83	7	\$1,060
15 APPEDCM30BBF	30"	16"	28"	92	8	\$1,107

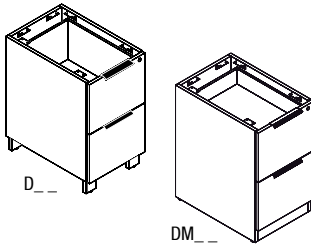

Supporting File/File, No Top (Face lock, APH1 handles)

Model#	Depth	Width	Height	Weight	Cube	Price
15 APPEDD20FF	20"	16"	28"	73	6	\$1,481
15 APPEDD24FF	24"	16"	28"	79	7	\$1,509
15 APPEDD30FF	30"	16"	28"	88	8	\$1,552
15 APPEDDM20FF	20"	16"	28"	73	6	\$995
15 APPEDDM24FF	24"	16"	28"	79	7	\$1,029
15 APPEDDM30FF	30"	16"	28"	88	8	\$1,074

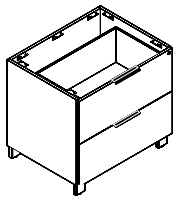

Supporting Lateral File, No Top (Face lock, APH1 handles)

Model#	Depth	Width	Height	Weight	Cube	Price
15 APPEDLF2031	20"	31"	28"	111	11	\$1,823
15 APPEDLF2036	20"	36"	28"	120	12	\$1,863
15 APPEDLF2431	24"	31"	28"	118	13	\$1,879
15 APPEDLF2436	24"	36"	28"	128	14	\$1,918

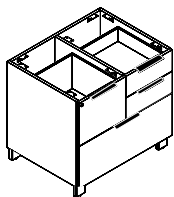

Supporting Personal Lateral File, No Top (Face lock, APH1 handles)

Model#	Depth	Width	Height	Weight	Cube	Price
15 APPEDPLF2031	20"	31"	28"	124	11	\$1,992
15 APPEDPLF2431	24"	31"	28"	132	13	\$2,038

Box drawers do not lock, (1) lock — locks file and lateral file drawer.

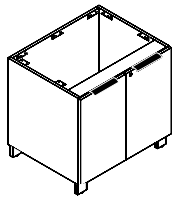

Supporting Hinged Door Cabinet, No Top (Face lock, APH1 handles)

Model#	Depth	Width	Height	Weight	Cube	Price
15 APPEDHDC2030	20"	30"	28"	91	10	\$1,616
15 APPEDHDC2036	20"	36"	28"	104	12	\$1,632
15 APPEDHDC2430	24"	30"	28"	101	12	\$1,645
15 APPEDHDC2436	24"	36"	28"	115	14	\$1,671

1 Adjustable ¾" shelf is standard.

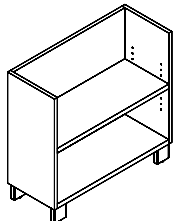

Supporting Bookcase Pedestal 1 Adjustable Shelf, No Top

Model#	Depth	Width	Height	Weight	Cube	Price
15 APPEDBC24	12"	24"	28"	61	5	\$687
15 APPEDBC30	12"	30"	28"	61	6	\$714

1 Adjustable ¾" shelf is standard.

NOTE: Pedestals with feet: silver is standard.
For black feet upgrade, add APUFEETB. For white, add APUFEETW.

apex series

Worksurface Supports

External Stabilizer Bar Specification Guide		Worksurface Width			
SUPPORT 1	SUPPORT 2	72"	66"	60"	54"
* A,D, DP-LEG	A,D, DP-LEG	* (2) APSB72	* (2) APSB66	* (2) APSB60	APSB54
* A,D, DP-LEG	T-LEG	* (2) APSB72	* (2) APSB66	* (2) APSB60	APSB54
A,D, DP-LEG	PEDESTAL (BBF or FF)	APSB60	APSB54	N/A	N/A
A,D, DP-LEG	LAT/PLF/HDC	N/A	N/A	N/A	N/A
T-LEG	T-LEG	APSB60	APSB54	N/A	N/A
T-LEG	PEDESTAL	APSB54	N/A	N/A	N/A
T-LEG	LAT/PLF/HDC	N/A	N/A	N/A	N/A
PEDESTAL	PEDESTAL	APSB54	N/A	N/A	N/A
PEDESTAL	LAT/PLF/HDC	N/A	N/A	N/A	N/A

* NOTE: 2 Stabilizer bars are required on 60", 66" & 72" wide worksurfaces when supported by left or right double post leg, D-legs or T-legs. If a modesty panel (TFM or HPL) is being specified only one stabilizer bar is required, acrylic modesty requires 2 stabilizer bars.

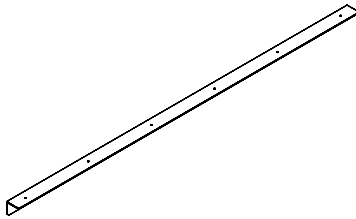

External Stabilizer Bar

Model#	Depth	Width	Height	Top Width	Weight	Cube	Price
APSB54	2"	35"	2"	54"	5	1	\$141
APSB60	2"	44"	2"	60"	6	1	\$155
APSB66	2"	50"	2"	66"	7	1	\$167
APSB72	2"	56"	2"	72"	8	1	\$181

* Reference stabilizer bar specification guide to determine stabilizer bar required. Stabilizer bars are recommended to be field installed 6" clear from approach side with #8 x 1" wood screws.

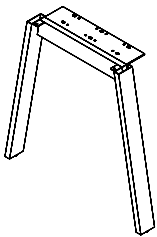

Apron Frame Leg, Silver Finish (Specify black or white finish)

Model#	Depth	Width	Height	Top Depth	Weight	Cube	Price
APOAL20	20"	7"	28"	20"	15	3	\$580
APOAL24	24"	7"	28"	24"	22	3	\$614
APOAL30	30"	7"	28"	30" & 36"	26	4	\$647
APOAL48	48"	7"	28"	48"	40	6	\$860
APOAL60	60"	7"	28"	60"	46	7	\$907

Silver legs are standard. For black leg upgrade add APULEGB, for white leg add APULEGW. NOTE: 2 stabilizer bars are required on 60", 66" & 72" wide worksurfaces when supporting with left & right apron frame leg. This leg style cannot be used for conference tables.

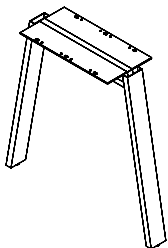

Shared Apron Frame Leg, Silver Finish (Specify black or white finish)

Model#	Depth	Width	Height	Top Depth	Weight	Cube	Price
APMAL20	20"	9"	28"	20"	26	3	\$738
APMAL24	24"	9"	28"	24"	32	4	\$790
APMAL30	30"	9"	28"	30" & 36"	36	5	\$827

Silver legs are standard. For black leg upgrade add APULEGB, for white leg add APULEGW. NOTE: 2 Stabilizer bars are required on 60", 66" & 72" wide worksurfaces when supporting with left & right apron frame leg. This leg style cannot be used for conference tables.

apex series

Worksurface Supports

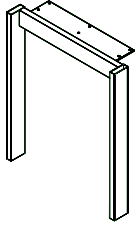

Double Post Leg, Silver Finish (Specify black or white finish)

Model#	Depth	Width	Height	Top Depth	Weight	Cube	Price
APODPL20	20"	7"	28"	20"	15	3	\$517
¹⁵ APODPL24	24"	7"	28"	24"	22	3	\$555
¹⁵ APODPL30	30"	7"	28"	30" & 36"	26	4	\$594
¹⁵ APODPL48	48"	7"	28"	48"	40	6	\$733
APODPL60	60"	7"	28"	60"	46	7	\$780

Silver legs are standard. For black leg upgrade add APULEGB • for white leg add APULEGW.
NOTE: 2 Stabilizer bars are required on 60", 66" & 72" wide worksurfaces when supporting with left & right double post leg.

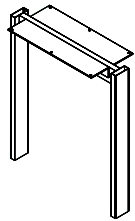

Shared Double Post Leg, Silver Finish (Specify black or white finish)

Model#	Depth	Width	Height	Top Depth	Weight	Cube	Price
APDPM20	20"	9"	28"	20"	26	3	\$624
¹⁵ APDPM24	24"	9"	28"	24"	32	4	\$691
¹⁵ APDPM30	30"	9"	28"	30" & 36"	36	5	\$750

Silver legs are standard. For black leg upgrade add APULEGB • for white leg add APULEGW.
* Use to support 2 worksurfaces.

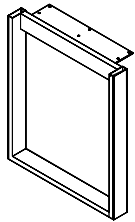

D-Leg, Silver Finish (Specify black or white finish)

Model#	Depth	Width	Height	Top Depth	Weight	Cube	Price
APODL20	20"	7"	28"	20"	19	3	\$634
¹⁵ APODL24	24"	7"	28"	24"	26	3	\$416
¹⁵ APODL30	30"	7"	28"	30" & 36"	29	4	\$443
¹⁵ APODL48	48"	7"	28"	48"	44	6	\$849
APODL60	60"	7"	28"	60"	50	7	\$934

Silver legs are standard. For black leg upgrade add APULEGB • for white leg add APULEGW.
NOTE: 2 Stabilizer bars are required on 60", 66" & 72" wide worksurfaces when supporting with left & right D-Leg.

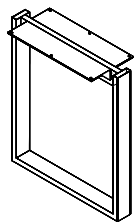

Shared D-Leg, Silver Finish (Specify black or white finish)

Model#	Depth	Width	Height	Top Depth	Weight	Cube	Price
APMDL20	20"	9"	28"	20"	28	3	\$780
¹⁵ APMDL24	24"	9"	28"	24"	37	4	\$810
¹⁵ APMDL30	30"	9"	28"	30" & 36"	40	5	\$864

Silver legs are standard. For black leg upgrade add APULEGB • for white leg add APULEGW.
* Use to support 2 worksurfaces
NOTE: 2 stabilizer bars are required on 60", 66" & 72" wide worksurfaces when supporting with left & right Shared D-Leg.

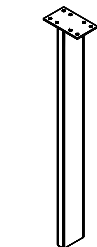

Single Post, Silver Finish (Specify black or white finish)

Model#	Depth	Width	Height	Weight	Cube	Price
¹⁵ APSPL28	5"	3"	28"	6	1	\$225

Silver legs are standard. For black leg upgrade add APULEGB • for white leg add APULEGW.
Field install with #8 x 1" wood screws. Use for bullet tops or additional support under top.

Worksurface Supports

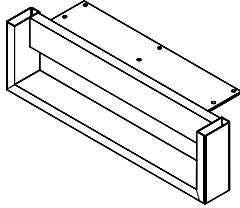

Short D-Leg, Silver Finish (Specify black or white finish)

Model#	Depth	Width	Height	Weight	Cube	Price
APOSDL20	20"	7"	6"	14	1	\$681
APOSDL24	24"	7"	6"	17	1	\$702
APOSDL30	30"	7"	6"	20	1	\$760

Silver legs are standard. For black leg upgrade add APULEGB • for white leg add APULEGW.
 * Supports worksurface below tops and above low credenza.
 Cannot be used when specifying modesty below worksurface.
 NOTE: 2 stabilizer bars are required on 60", 66" & 72" wide worksurfaces when supporting with left & right Short D-Leg.

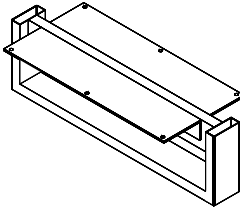

Short D-Leg Shared, Silver Finish (Specify black or white finish)

Model#	Depth	Width	Height	Weight	Cube	Price
APMSDL20	20"	9"	6"	23	1	\$648
APMSDL24	24"	9"	6"	26	1	\$681
APMSDL30	30"	9"	6"	29	1	\$750

Silver legs are standard. For black leg upgrade add APULEGB • for white leg add APULEGW.
 * Use to support 2 worksurfaces above low credenzas.
 Cannot be used when specifying modesty below worksurface.
 NOTE: 2 stabilizer bars are required on 60", 66" & 72" wide worksurfaces when supporting with left & right Short D-Leg Shared.

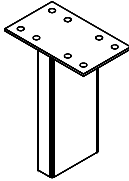

Low Post Leg, Silver Finish (Specify black or white finish)

Model#	Depth	Width	Height	Weight	Cube	Price
APSPL6	5"	3"	6"	5	1	\$98

Silver legs are standard. For black leg upgrade add APULEGB • for white leg add APULEGW.
 * Supports worksurface below tops and above low credenza.
 Field install with #8 x 1" wood screws.

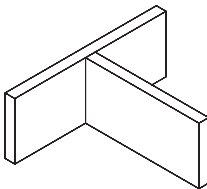

Support T-Leg, TFM (For low credenza)

Model#	Depth	Width	Height	Fits Top Depth	Weight	Cube	Price
APTLEG2006	12"	13"	6"	20"	3	1	\$176
¹⁵ APTLEG2406	16"	13"	6"	24"	4	1	\$182
¹⁵ APTLEG3006	22"	13"	6"	30"	5	1	\$192

Must be ordered when specifying modesty below worksurface.
 Supports worksurface above low credenza, pin and cam connection to worksurface underside.

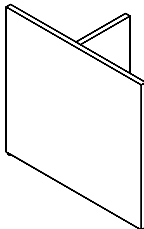

T-Leg (TFM leg)

Model#	Depth	Width	Height	Weight	Cube	Price
¹⁵ APTLEG20	20"	13"	28"	26	5	\$191
¹⁵ APTLEG24	24"	13"	28"	27	6	\$207
¹⁵ APTLEG30	30"	13"	28"	31	7	\$215

NOTE: 2 stabilizer bars are required on 60", 66" & 72" wide worksurfaces when supporting with left & right T-leg.

Worksurface Supports, Bases

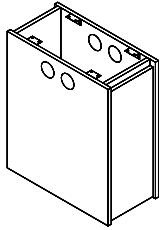

Square Panel Base (Hollow with end access door)

Model#	Depth	Width	Height	Weight	Cube	Price
APLEGM1224	12"	24"	28"	47	5	\$605
APLEGM1230	12"	30"	28"	56	6	\$740

4 grommet cutouts standard.
To be used with shared worksurfaces and wire management troughs.

Adjustable Bases

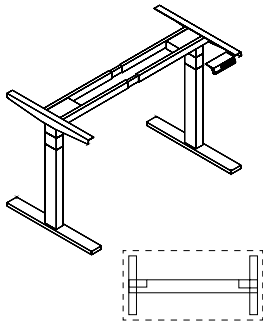

Adjustable Height Electrical Base

Model#	Base (D)	Base (W)	Height	Fits Top Size	Color	Weight	Cube	Price
MMLEGAHE24S3	22"	47-72"	23 1/2-49"	24"D-72"W	Silver	66	1	\$1,498
MMLEGAHE24B3	22"	47-72"	23 1/2-49"	24"D-72"W	Black	66	1	\$1,498
MMLEGAHE24W3	22"	47-72"	23 1/2-49"	24"D-72"W	White	66	1	\$1,498
MMLEGAHE30S3	28"	47-72"	23 1/2-49"	30"D-72"W	Silver	66	1	\$1,498
MMLEGAHE30B3	28"	47-72"	23 1/2-49"	30"D-72"W	Black	66	1	\$1,498
MMLEGAHE30W3	28"	47-72"	23 1/2-49"	30"D-72"W	White	66	1	\$1,498

3 Stage base.
Bases ship unassembled unless otherwise specified. For base functions see training section.

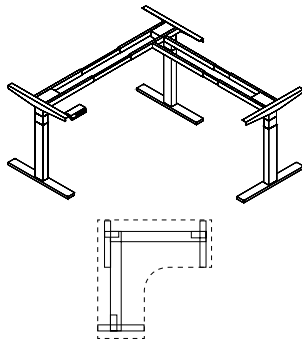

Adjustable Height Electrical L-Unit Base (Sit to stand, fits top sizes below)

Model#	Base (D)	Base (W)	Height	Fits Top Size	Color	Weight	Cube	Price
MMLEGAHEL24B3	22"	48-72"	23 1/2-49"	24"D-72"W	Black	112	1	\$2,295
MMLEGAHEL24S3	22"	48-72"	23 1/2-49"	24"D-72"W	Silver	112	1	\$2,295
MMLEGAHEL24W3	22"	48-72"	23 1/2-49"	24"D-72"W	White	112	1	\$2,295
MMLEGAHEL30S3	28"	48-72"	23 1/2-49"	30"D-72"W	Silver	112	1	\$2,295
MMLEGAHEL30W3	28"	48-72"	23 1/2-49"	30"D-72"W	White	112	1	\$2,295
MMLEGAHEL30B3	28"	48-72"	23 1/2-49"	30"D-72"W	Black	112	1	\$2,295

3 Stage base.
Bases ship unassembled unless otherwise specified. For base functions see training section.

apex series

Privacy Screens

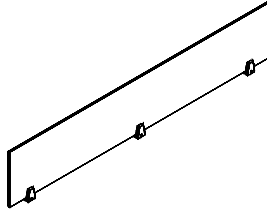

Frosted Acrylic Privacy Screen (3/8" Thick acrylic)

Model#	Depth	Width	Height	Weight	Cube	Price
APPSU24	1"	17"	12"	4	1	\$263
APPSU30	1"	23"	12"	6	1	\$328
APPSU36	1"	29"	12"	7	1	\$426
APPSU42	1"	35"	12"	8	1	\$468
15 APPSU48	1"	41"	12"	9	1	\$574
APPSU54	1"	47"	12"	10	1	\$822
15 APPSU60	1"	53"	12"	11	1	\$829
APPSU66	1"	59"	12"	12	1	\$835
15 APPSU72	1"	65"	12"	13	1	\$844

* Privacy screens APPSU24 thru APPSU48 include 2 mounting clips.

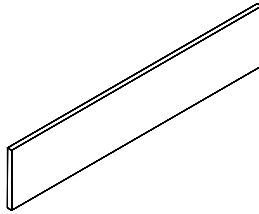

TFM Privacy Screen (1" Thick)

Model#	Depth	Width	Height	Weight	Cube	Price
APPSUW2412	1"	17"	12"	8	1	\$124
APPSUW3012	1"	23"	12"	10	1	\$124
APPSUW3612	1"	29"	12"	12	1	\$145
APPSUW4212	1"	35"	12"	14	1	\$145
APPSUW4812	1"	41"	12"	15	1	\$158
APPSUW5412	1"	47"	12"	17	1	\$158
15 APPSUW6012	1"	53"	12"	19	1	\$182
APPSUW6612	1"	59"	12"	21	1	\$193
15 APPSUW7212	1"	65"	12"	23	1	\$193

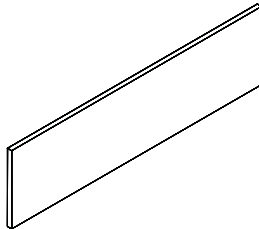

TFM Privacy Screen (1" Thick)

Model#	Depth	Width	Height	Weight	Cube	Price
APPSUW2415	1"	17"	15"	10	1	\$248
APPSUW3015	1"	23"	15"	12	1	\$248
APPSUW3615	1"	29"	15"	15	1	\$286
APPSUW4215	1"	35"	15"	17	1	\$286
APPSUW4815	1"	41"	15"	19	1	\$321
APPSUW5415	1"	47"	15"	22	1	\$321
15 APPSUW6015	1"	53"	15"	24	1	\$363
APPSUW6615	1"	59"	15"	26	1	\$389
15 APPSUW7215	1"	65"	15"	27	1	\$389

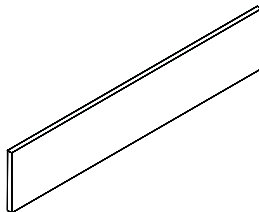

HPL Privacy Screen (1" Thick)

Model#	Depth	Width	Height	Weight	Cube	Price
APPSUHP2412	1"	17"	12"	8	1	\$182
APPSUHP3012	1"	23"	12"	10	1	\$182
APPSUHP3612	1"	29"	12"	12	1	\$219
APPSUHP4212	1"	35"	12"	14	1	\$219
APPSUHP4812	1"	41"	12"	15	1	\$269
APPSUHP5412	1"	47"	12"	17	1	\$269
APPSUHP6012	1"	53"	12"	19	1	\$324
APPSUHP6612	1"	59"	12"	21	1	\$355
APPSUHP7212	1"	65"	12"	23	1	\$355

NOTE: TFM & HPL Privacy Screens cannot be field installed.

Privacy Screens

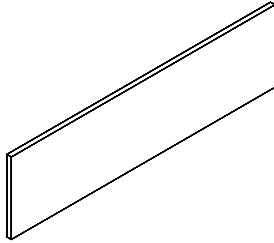

HPL Privacy Screen (1" Thick)

Model#	Depth	Width	Height	Weight	Cube	Price
APPSUHP2415	1"	17"	15"	10	1	\$363
APPSUHP3015	1"	23"	15"	12	1	\$363
APPSUHP3615	1"	29"	15"	15	1	\$439
APPSUHP4215	1"	35"	15"	17	1	\$439
APPSUHP4815	1"	41"	15"	19	1	\$534
APPSUHP5415	1"	47"	15"	22	1	\$534
APPSUHP6015	1"	53"	15"	24	1	\$649
APPSUHP6615	1"	59"	15"	26	1	\$705
APPSUHP7215	1"	65"	15"	29	1	\$705

Privacy screens location: Center (left to right) is standard on worksurfaces.
For custom location, must be specified. Add MMCUT3 \$234/each.

Privacy Screen Extensions

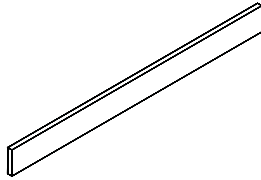

TFM Extension (1" Thick) for Frosted Acrylic Privacy Screens

Model#	Depth	Width	Height	Weight	Cube	Price
APPSUW2406	1"	17"	6"	3	1	\$124
APPSUW3006	1"	23"	6"	4	1	\$124
APPSUW3606	1"	29"	6"	5	1	\$145
APPSUW4206	1"	35"	6"	6	1	\$145
APPSUW4806	1"	41"	6"	7	1	\$158
APPSUW5406	1"	47"	6"	8	1	\$158
APPSUW6006	1"	53"	6"	9	1	\$182
APPSUW6606	1"	59"	6"	10	1	\$193
APPSUW7206	1"	65"	6"	11	1	\$193

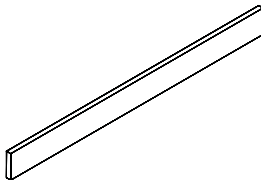

HPL Extension (1" Thick) for Frosted Acrylic Privacy Screens

Model#	Depth	Width	Height	Weight	Cube	Price
APPSUHP2406	1"	17"	6"	3	1	\$182
APPSUHP3006	1"	23"	6"	4	1	\$182
APPSUHP3606	1"	29"	6"	5	1	\$219
APPSUHP4206	1"	35"	6"	6	1	\$219
APPSUHP4806	1"	41"	6"	7	1	\$269
APPSUHP5406	1"	47"	6"	8	1	\$269
APPSUHP6006	1"	53"	6"	9	1	\$324
APPSUHP6606	1"	59"	6"	10	1	\$355
APPSUHP7206	1"	65"	6"	11	1	\$355

NOTE: TFM & HPL Privacy Screens cannot be field installed.

Modesty Panels

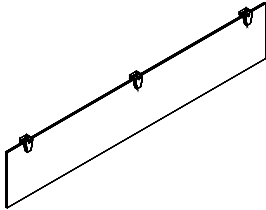

Frosted Acrylic Modesty (3/8" thick acrylic)

Model#	Depth	Width	Height	Weight	Cube	Price
APPSL24	1"	17"	12"	4	1	\$263
APPSL30	1"	23"	12"	6	1	\$328
APPSL36	1"	29"	12"	7	1	\$426
APPSL42	1"	35"	12"	8	1	\$468
15 APPSL48	1"	41"	12"	9	2	\$574
APPSL54	1"	47"	12"	10	2	\$822
15 APPSL60	1"	53"	12"	11	2	\$829
APPSL66	1"	59"	12"	12	2	\$835
15 APPSL72	1"	65"	12"	13	2	\$844

* Modesties APPSL24 thru APPSL48 include 2 mounting clips.

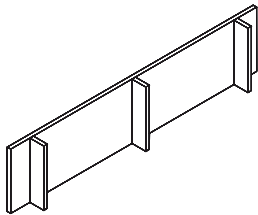

TFM Modesty (3/4" thick)

Model#	Depth	Width	Height	Weight	Cube	Price
APPSLW24	4"	17"	12"	7	1	\$124
APPSLW30	4"	23"	12"	8	1	\$124
APPSLW36	4"	29"	12"	10	1	\$145
APPSLW42	4"	35"	12"	11	1	\$145
APPSLW48	4"	41"	12"	13	2	\$158
APPSLW54	4"	47"	12"	15	2	\$158
15 APPSLW60	4"	53"	12"	16	2	\$182
APPSLW66	4"	59"	12"	18	2	\$193
15 APPSLW72	4"	65"	12"	19	2	\$193

* 3/4" thick TFM. Modesties APPSLW24 thru APPSLW48 include 2 vertical supports.

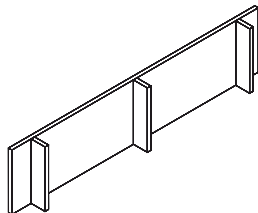

HPL Modesty (3/4" thick)

Model#	Depth	Width	Height	Weight	Cube	Price
APPSLHP24	4"	17"	12"	7	1	\$182
APPSLHP30	4"	23"	12"	8	1	\$182
APPSLHP36	4"	29"	12"	10	1	\$219
APPSLHP42	4"	35"	12"	11	1	\$219
APPSLHP48	4"	41"	12"	13	2	\$269
APPSLHP54	4"	47"	12"	15	2	\$269
APPSLHP60	4"	53"	12"	16	2	\$324
APPSLHP66	4"	59"	12"	18	2	\$355
APPSLHP72	4"	65"	12"	19	2	\$355

* 3/4" thick HPL. Modesties APPSLHP24 thru APPSLHP48 include 2 vertical supports.

Modesty Panel Standard Location:

Center left to right and flush to approach side is standard under worksurfaces, except 36"D tops, inset is 6". For custom location, must be specified. Add MMCUT3 \$234/each.

apex series

Low Credenzas

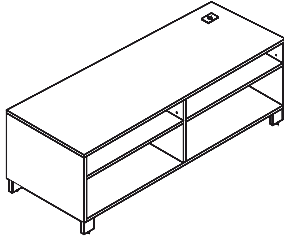

Left Open Credenza, Silver Feet, 2 Adjustable shelves, 4 Grommets (Specify black or white feet)

Model#	Depth	Width	Height	Weight	Cube	Price
APD02448L	24"	48"	22"	132	15	\$1,828
APD02460L	24"	60"	22"	156	19	\$2,101
APD02466L	24"	66"	22"	167	21	\$2,147
APD02472L	24"	72"	22"	179	22	\$2,212

Silver feet are standard. For black feet upgrade add APUFEETB, for white feet add APUFEETW.
* Standard right silver square grommet on top, modesty, adjustable shelf and bottom shelf.

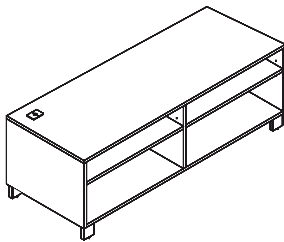

Right Open Credenza, Silver Feet, 2 Adjustable Shelves, 4 Grommets (Specify black or white feet)

Model#	Depth	Width	Height	Weight	Cube	Price
APD02448R	24"	48"	22"	132	15	\$1,828
APD02460R	24"	60"	22"	156	19	\$2,101
APD02466R	24"	66"	22"	167	21	\$2,147
APD02472R	24"	72"	22"	179	22	\$2,212

Silver feet are standard. For black feet upgrade add APUFEETB, for white feet add APUFEETW.
* Standard left silver square grommet on top, modesty, adjustable shelf and bottom shelf.

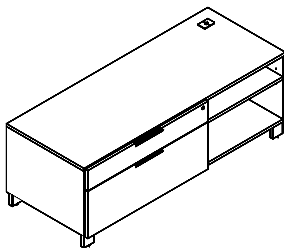

Left Single Box/Lateral Credenza,
Silver Feet, Locking, 1 Adjustable shelf, 4 Grommets (Specify black or white feet)

Model#	Depth	Width	Height	Weight	Cube	Price
APSBL2048L	20"	48"	22"	147	13	\$2,317
15 APSBL2060L	20"	60"	22"	165	16	\$2,419
APSBL2066L	20"	66"	22"	173	17	\$2,469
15 APSBL2072L	20"	72"	22"	182	19	\$2,515
APSBL2448L	24"	48"	22"	161	15	\$2,402
15 APSBL2460L	24"	60"	22"	181	19	\$2,547
APSBL2466L	24"	66"	22"	191	21	\$2,627
15 APSBL2472L	24"	72"	22"	201	22	\$2,705

Silver feet are standard. For black feet upgrade add APUFEETB, for white feet add APUFEETW.
* Standard right silver square grommet on top, modesty, adjustable shelf and bottom shelf.
31"W Box/Lateral file on 48"W credenzas only.

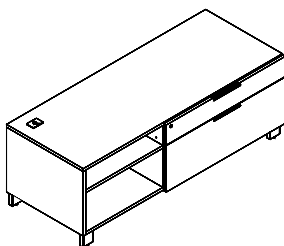

Right Single Box/Lateral Credenza,
Silver Feet, Locking, 1 Adjustable Shelf, 4 Grommets (Specify black or white feet)

Model#	Depth	Width	Height	Weight	Cube	Price
APSBL2048R	20"	48"	22"	147	13	\$2,317
15 APSBL2060R	20"	60"	22"	165	16	\$2,419
APSBL2066R	20"	66"	22"	173	17	\$2,469
15 APSBL2072R	20"	72"	22"	182	19	\$2,515
APSBL2448R	24"	48"	22"	161	15	\$2,402
15 APSBL2460R	24"	60"	22"	181	19	\$2,547
APSBL2466R	24"	66"	22"	191	21	\$2,627
15 APSBL2472R	24"	72"	22"	201	22	\$2,705

Silver feet are standard. For black feet upgrade add APUFEETB, for white feet add APUFEETW.
* Standard left silver square grommet on top, modesty, adjustable shelf and bottom shelf.
31"W Box/Lateral file on 48"W credenzas only.

apex series

Low Credenzas

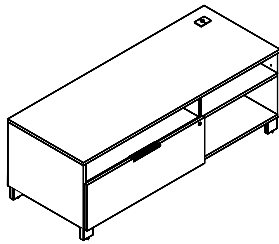

Left Single Lateral Credenza,
Silver Feet, Locking, 1 Adjustable Shelf, 4 Grommets (Specify black or white feet)

Model#	Depth	Width	Height	Weight	Cube	Price
APSL02048L	20"	48"	22"	142	13	\$2,188
APSL02060L	20"	60"	22"	163	16	\$2,442
APSL02066L	20"	66"	22"	173	17	\$2,491
APSL02072L	20"	72"	22"	183	19	\$2,547
APSL02448L	24"	48"	22"	159	15	\$2,268
APSL02460L	24"	60"	22"	184	19	\$2,547
APSL02466L	24"	66"	22"	195	21	\$2,610
APSL02472L	24"	72"	22"	207	22	\$2,667

Silver feet are standard. For black feet upgrade add APUFEETB, for white feet add APUFEETW.
* Standard left silver square grommet on top, modesty, adjustable shelf and bottom shelf.
31"W Box/Lateral file on 48"W credenzas only.

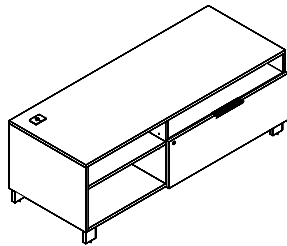

Right Single Lateral Credenza,
Silver Feet, Locking, 1 Adjustable Shelf, 4 Grommets (Specify black or white feet)

Model#	Depth	Width	Height	Weight	Cube	Price
APSL02048R	20"	48"	22"	142	13	\$2,188
APSL02060R	20"	60"	22"	163	16	\$2,442
APSL02066R	20"	66"	22"	173	17	\$2,491
APSL02072R	20"	72"	22"	183	19	\$2,547
APSL02448R	24"	48"	22"	159	15	\$2,268
APSL02460R	24"	60"	22"	184	19	\$2,547
APSL02466R	24"	66"	22"	195	21	\$2,610
APSL02472R	24"	72"	22"	207	22	\$2,667

Silver feet are standard. For black feet upgrade add APUFEETB, for white feet add APUFEETW.
* Standard left silver square grommet on top, modesty, adjustable shelf and bottom shelf.
31"W Box/Lateral file on 48"W credenzas only.

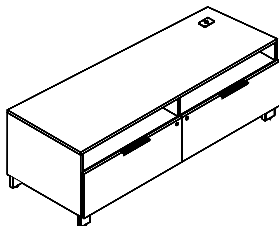

Left Double Lateral Credenza, Silver Feet, Locking, 2 Grommets (Specify black or white feet)

Model#	Depth	Width	Height	Weight	Cube	Price
APDOL2061L	20"	61"	22"	196	16	\$2,705
APDOL2072L	20"	72"	22"	219	19	\$2,785
APDOL2461L	24"	61"	22"	218	19	\$2,856
APDOL2472L	24"	72"	22"	244	22	\$2,912

Silver feet are standard. For black feet upgrade add APUFEETB, for white feet add APUFEETW.
* Standard right silver square grommet on top & modesty.

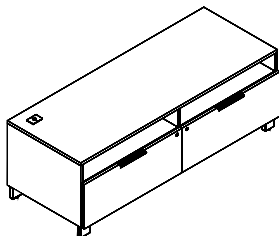

Right Double Lateral Credenza, Silver Feet, Locking, 2 Grommets (Specify black or white feet)

Model#	Depth	Width	Height	Weight	Cube	Price
APDOL2061R	20"	61"	22"	196	16	\$2,705
APDOL2072R	20"	72"	22"	219	19	\$2,785
APDOL2461R	24"	61"	22"	218	19	\$2,856
APDOL2472R	24"	72"	22"	244	22	\$2,912

Silver feet are standard. For black feet upgrade add APUFEETB, for white feet add APUFEETW.
* Standard left silver square grommet on top & modesty.

apex series

Freestanding Storage

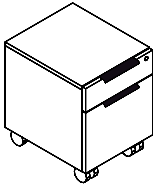

Mobile Pedestal (Box/File, Locking)

Model#	Depth	Width	Height	Weight	Cube	Price
15 APPEDEX20BF	20"	16"	22"	73	5	\$1,249
15 APPEDEX24BF	24"	16"	22"	78	7	\$1,280

* Seating weight capacity 175lbs.

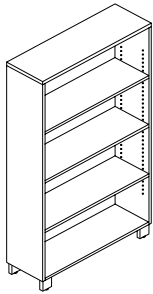

Bookcase, Silver Feet (Specify black or white feet)

Model#	Depth	Width	Height	# of Shelves	Weight	Cube	Price
APBC30	12"	36"	29"	1	66	8	\$880
APBC54	12"	36"	54"	2	107	14	\$1,125
APBC65	12"	36"	65"	3	137	17	\$1,323

Silver feet are standard. For black feet upgrade add APUFEETB, for white feet add APUFEETW. Adjustable shelves are 3/4" thick, recommended weight is 20 lbs each, distributed evenly. Back panel color upgrade, add model# MMCPF \$172 (N/A for adjustable shelves).

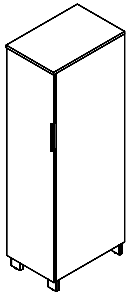

Left Single Storage Cabinet, Silver Feet (Specify black or white feet)

Model#	Depth	Width	Height	# of Shelves	Weight	Cube	Price
APSTS2054L	20"	16"	54"	2	112	10	\$1,964
APSTS2065L	20"	16"	65"	3	135	13	\$2,070
APSTS2454L	24"	16"	54"	2	126	12	\$2,062
15 APSTS2465L	24"	16"	65"	3	151	15	\$2,188

Silver feet are standard. For black feet upgrade add APUFEETB, for white feet add APUFEETW. Optional lock available, add MMFL \$113. Adjustable shelves are 3/4" thick.

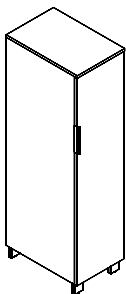

Right Single Storage Cabinet, Silver Feet (Specify black or white feet)

Model#	Depth	Width	Height	# of Shelves	Weight	Cube	Price
APSTS2054R	20"	16"	54"	2	112	10	\$1,964
APSTS2065R	20"	16"	65"	3	135	13	\$2,070
APSTS2454R	24"	16"	54"	2	126	12	\$2,062
15 APSTS2465R	24"	16"	65"	3	151	15	\$2,188

Silver feet are standard. For black feet upgrade add APUFEETB, for white feet add APUFEETW. Optional lock available, add MMFL \$113. Adjustable shelves are 3/4" thick.

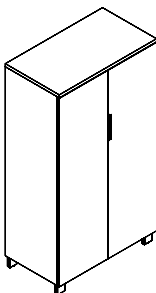

Double Storage Cabinet, Silver Feet (Specify black or white feet)

Model#	Depth	Width	Height	# of Shelves	Weight	Cube	Price
APDST2054	20"	36"	54"	2	188	23	\$2,388
APDST2065	20"	36"	65"	3	228	28	\$2,585
APDST2454	24"	36"	54"	2	209	27	\$2,491
APDST2465	24"	36"	65"	3	253	33	\$2,690

Silver feet are standard. For black feet upgrade add APUFEETB, for white feet add APUFEETW. Optional lock available, add MMFL \$113. Adjustable shelves are 3/4" thick.

Refer to color page 163 for TFM color options.

Freestanding Storage

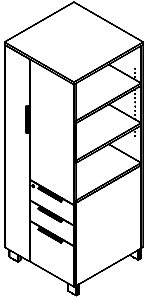

Left Personal Bookcase Storage Cabinet,
Silver Feet, Box/Box/File, Locking (Specify black or white feet)

Model#	Depth	Width	Height	# of Shelves	Weight	Cube	Price
APPBSC2054L	20"	24"	54"	3	178	15	\$2,292
APPBSC2065L	20"	24"	65"	5	208	19	\$2,381
APPBSC2454L	24"	24"	54"	3	198	18	\$2,323
APPBSC2465L	24"	24"	65"	5	229	22	\$2,427

Silver feet are standard. For black feet upgrade add APUFEETB, for white feet add APUFEETW.
* No coat rack. 2 Adjustable shelves on long compartment on 54"H, and 3 adjustable shelves on 65"H.
Optional face lock for hinged door available, add MMFL \$118. Adjustable shelves are 3/4" thick.

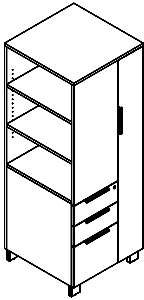

Right Personal Bookcase Storage Cabinet,
Silver Feet, Box/Box/File, Locking (Specify black or white feet)

Model#	Depth	Width	Height	# of Shelves	Weight	Cube	Price
APPBSC2054R	20"	24"	54"	3	178	15	\$2,292
APPBSC2065R	20"	24"	65"	5	208	19	\$2,381
APPBSC2454R	24"	24"	54"	3	198	18	\$2,323
APPBSC2465R	24"	24"	65"	5	229	22	\$2,427

Silver feet are standard. For black feet upgrade add APUFEETB, for white feet add APUFEETW.
* No coat rack. 2 Adjustable shelves on long compartment on 54"H, and 3-adjustable shelves on 65"H.
Optional face lock for hinged door available, add MMFL \$118. Adjustable shelves are 3/4" thick.

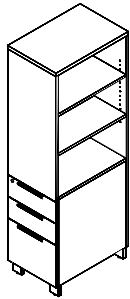

Left Single Personal Bookcase Cabinet,
Silver Feet, Box/Box/File, Locking (Specify black or white feet)

Model#	Depth	Width	Height	# of Shelves	Weight	Cube	Price
APBCPS2054L	20"	16"	54"	1	126	10	\$2,155
APBCPS2065L	20"	16"	65"	2	143	13	\$2,221
APBCPS2454L	24"	16"	54"	1	137	12	\$2,268
APBCPS2465L	24"	16"	65"	2	157	15	\$2,338

Silver feet are standard. For black feet upgrade add APUFEETB, for white feet add APUFEETW.
Adjustable shelves are 3/4" thick.

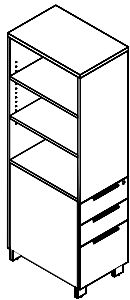

Right Single Personal Bookcase Cabinet,
Silver Feet, Box/Box/File, Locking (Specify black or white feet)

Model#	Depth	Width	Height	# of Shelves	Weight	Cube	Price
APBCPS2054R	20"	16"	54"	1	126	10	\$2,155
APBCPS2065R	20"	16"	65"	2	143	13	\$2,221
APBCPS2454R	24"	16"	54"	1	137	12	\$2,268
APBCPS2465R	24"	16"	65"	2	157	15	\$2,338

Silver feet are standard. For black feet upgrade add APUFEETB, for white feet add APUFEETW.
Adjustable shelves are 3/4" thick.

apex series

Freestanding Storage

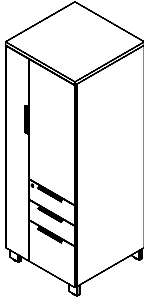

Left Personal Wardrobe Cabinet,
Silver Feet, Box/Box/File, Locking (Specify black or white feet)

Model#	Depth	Width	Height	# of Shelves	Weight	Cube	Price
APWCP2454L	24"	24"	54"	1	208	18	\$2,363
APWCP2465L	24"	24"	65"	2	239	22	\$2,474

Silver feet are standard. For black feet upgrade add APUFEETB, for white feet add APUFEETW.
* Coat rack bar in long compartment included. Adjustable shelves are 3/4" thick.
Optional face lock for hinged door available (two required), add MMFL \$118/each.

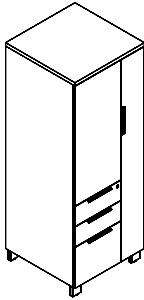

Right Personal Wardrobe Cabinet,
Silver Feet, Box/Box/File, Locking (Specify black or white feet)

Model#	Depth	Width	Height	# of Shelves	Weight	Cube	Price
APWCP2454R	24"	24"	54"	1	208	18	\$2,363
APWCP2465R	24"	24"	65"	2	239	22	\$2,474

Silver feet are standard. For black feet upgrade add APUFEETB, for white feet add APUFEETW.
* Coat rack bar in long compartment included. Adjustable shelves are 3/4" thick.
Optional face lock for hinged door available (2 required), add MMFL \$118/each.

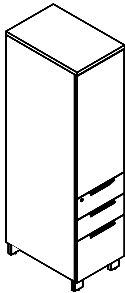

Left Single Storage Cabinet,
Silver Feet, Box/Box/File, Locking (Specify black or white feet)

Model#	Depth	Width	Height	# of Shelves	Weight	Cube	Price
APBCV2054L	20"	16"	54"	1	136	10	\$2,371
APBCV2065L	20"	16"	65"	2	153	13	\$2,469
APBCV2454L	24"	16"	54"	1	147	12	\$2,474
APBCV2465L	24"	16"	65"	2	167	15	\$2,547

Silver feet are standard. For black feet upgrade add APUFEETB, for white feet add APUFEETW.
Optional face lock for hinged door available, add MMFL \$118. Adjustable shelves are 3/4" thick.

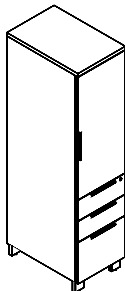

Right Single Storage Cabinet,
Silver Feet, Box/Box/File, Locking (Specify black or white feet)

Model#	Depth	Width	Height	# of Shelves	Weight	Cube	Price
APBCV2054R	20"	16"	54"	1	136	10	\$2,371
APBCV2065R	20"	16"	65"	2	153	13	\$2,469
APBCV2454R	24"	16"	54"	1	147	12	\$2,474
APBCV2465R	24"	16"	65"	2	167	15	\$2,547

Silver feet are standard. For black feet upgrade add APUFEETB, for white feet add APUFEETW.
Optional face lock for hinged door available, add MMFL \$118. Adjustable shelves are 3/4" thick.

apex series

Overhead Storage

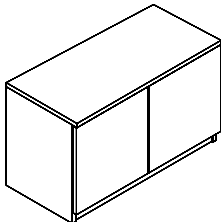
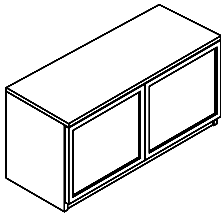
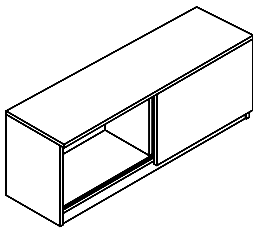
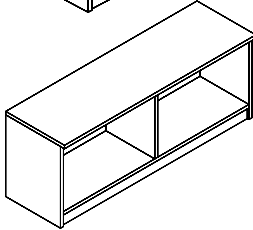
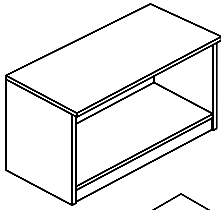

Wall Mount Cabinet, No Doors, with Fascia

Model#	Depth	Width	Height	Weight	Cube	Price
15 APCFOH030	14 3/4"	30"	18 1/2"	47	5	\$757
15 APCFOH036	14 3/4"	36"	18 1/2"	53	6	\$899
APCFOH042	14 3/4"	42"	18 1/2"	63	7	\$1,042
APCFOH048	14 3/4"	48"	18 1/2"	69	8	\$1,107

Optional tasklight APTSKLTX24, add \$283. 42"W & 48"W cabinet has center divider.
Requires professional installation and must be mounted to wall stud.
35lb. weight capacity distributed evenly.

Wall Mount Cabinet with One Sliding Door, with Fascia

Model#	Depth	Width	Height	Weight	Cube	Price
APCFOHS30	14 3/4"	30"	18 1/2"	58	5	\$1,049
APCFOHS36	14 3/4"	36"	18 1/2"	65	6	\$1,194
APCFOHS42	14 3/4"	42"	18 1/2"	71	7	\$1,340
APCFOHS48	14 3/4"	48"	18 1/2"	78	8	\$1,426

* No lock available. Optional tasklight APTSKLTX24, add \$291.
Requires professional installation and must be mounted to wall stud.
35lb. weight capacity distributed evenly.

Wall Mount Cabinet with Frosted Glass Doors, with Fascia

Model#	Depth	Width	Height	Weight	Cube	Price
APCFOHG36	14 3/4"	36"	18 1/2"	63	6	\$1,369

* No lock available. Optional tasklight APTSKLTX24, add \$291.
Requires professional installation and must be mounted to wall stud.
35lb. weight capacity distributed evenly.

Wall Mount Cabinet with Laminate Hinged Doors, with Fascia

Model#	Depth	Width	Height	# of Doors	Weight	Cube	Price
15 APCFOHD30	14 3/4"	30"	18 1/2"	2	58	5	\$1,107
15 APCFOHD36	14 3/4"	36"	18 1/2"	2	67	6	\$1,138
APCFOHD42	14 3/4"	42"	18 1/2"	2	79	7	\$1,306
APCFOHD48	14 3/4"	48"	18 1/2"	4	87	8	\$1,347

Optional tasklight APTSKLTX24, add \$291.
Optional face lock available (2 required for 42" & 48" wide), add MMFL \$118/each.
Requires professional installation and must be mounted to wall stud.
35lb. weight capacity distributed evenly.

apex series

Hutches

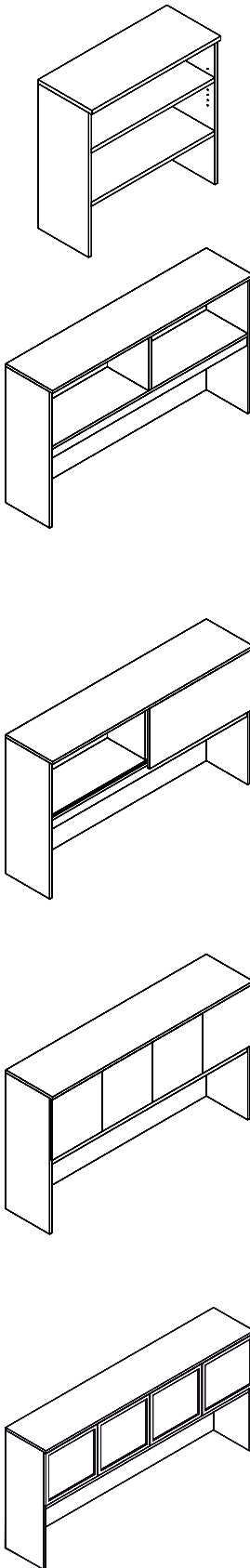

Bookcase Hutch, 1 Fixed and 1 Adjustable Shelf

Model#	Depth	Width	Height	Weight	Cube	Price
APBCH36	14"	36"	36"	79	11	\$632

Bottom clearance 12"H.
35lb. weight capacity distributed evenly.

Hutch, No Doors, with Fascia

Model#	Depth	Width	Height	Weight	Cube	Price
APH36ND	14"	36"	36"	71	11	\$835
APH42ND	14"	42"	36"	84	13	\$930
APH48ND	14"	48"	36"	92	14	\$1,029
APH54ND	14"	54"	36"	100	16	\$1,074
APH60ND	14"	60"	36"	109	18	\$1,122
APH66ND	14"	66"	36"	116	20	\$1,187
APH72ND	14"	72"	36"	125	21	\$1,249

Optional tasklight APTSKLTX24, add \$291.
Bottom clearance 17 1/4" from fascia.
35lb. weight capacity distributed evenly.

Hutch with One Sliding Door, with Fascia

Model#	Depth	Width	Height	Weight	Cube	Price
APH36SD	14"	36"	36"	81	11	\$1,201
APH42SD	14"	42"	36"	92	13	\$1,289
APH48SD	14"	48"	36"	99	14	\$1,377
APH54SD	14"	54"	36"	108	16	\$1,463
APH60SD	14"	60"	36"	118	18	\$1,552
APH72SD	14"	72"	36"	136	21	\$1,640

* No lock available. Optional tasklight APTSKLTX24, add \$291.
Bottom clearance 17 1/4" from fascia.
35lb. weight capacity distributed evenly.

Hutch with Laminate Hinged Doors, with Fascia

Model#	Depth	Width	Height	# of Doors	Weight	Cube	Price
APH36WD	14"	36"	36"	2	83	11	\$1,074
APH42WD	14"	42"	36"	2	98	13	\$1,211
APH48WD	14"	48"	36"	4	108	14	\$1,359
APH54WD	14"	54"	36"	4	118	16	\$1,426
APH60WD	14"	60"	36"	4	129	18	\$1,487
APH66WD	14"	66"	36"	4	139	20	\$1,579
APH72WD	14"	72"	36"	4	149	21	\$1,641

Optional tasklight APTSKLTX24, add \$291.
Optional face locks (2 locks are required for 42"W & 4 door hutches) MMFL, add \$118/each.
Bottom clearance 17 1/4" from fascia.
35lb. weight capacity distributed evenly.

Hutch with Frosted Glass Doors, with Fascia

Model#	Depth	Width	Height	# of Doors	Weight	Cube	Price
APH36WG	14"	36"	36"	2	82	11	\$1,377
APH72WG	14"	72"	36"	4	145	21	\$2,336

* No lock available. Optional tasklight APTSKLTX24, add \$291.
Bottom clearance 17 1/4" from fascia.
35lb. weight capacity distributed evenly.

NOTES: Back panel color upgrade, add model# MMCPF \$172
Refer to color page 163 for TFM color options.

apex series

Hutches

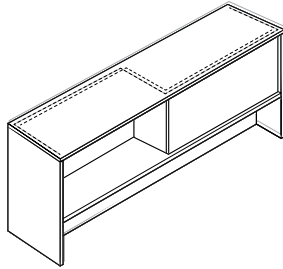

Two-Sided Hutch with Open Shared Bins

Model#	Depth	Width	Height	Weight	Cube	Price
APHSB60	14"	60"	25"	84	13	\$1,217
APHSB66	14"	66"	25"	91	14	\$1,265
APHSB72	14"	72"	25"	97	15	\$1,312

Bottom clearance 9"H. Optional tackboards available for lower and upper section. 35lb. weight capacity distributed evenly.

Tasklight

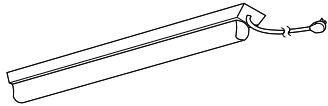

Tasklight, Black (Additional option for hutch or wall mount cabinets)

Model#	Depth	Width	Height	Weight	Cube	Price
APTKLTX24	7/8"	24 1/2"	1 7/8"	1	1	\$291

LED light. Inter connect to other lights, can link up to 6 units max. One grommet is included on hutch back panel.

Tackboards

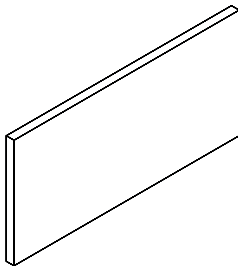

Tackboard (For hutches with 36" height)

Model#	Depth	Width	Height	Hutch Width	Weight	Cube	Price
APTKBD1936	1/2"	34"	19"	36"	6	1	\$445
APTKBD1942	1/2"	40"	19"	42"	7	1	\$557
¹⁵ APTKBD1948	1/2"	46"	19"	48"	8	1	\$590
APTKBD1954	1/2"	52"	19"	54"	9	1	\$605
¹⁵ APTKBD1960	1/2"	58"	19"	60"	10	1	\$683
APTKBD1966	1/2"	64"	19"	66"	11	1	\$733
¹⁵ APTKBD1972	1/2"	70"	19"	72"	12	1	\$781

For fabric options, see page 163.

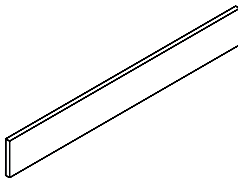

Tackboard (Lower) for Two Sided Hutch

Model#	Depth	Width	Height	Hutch Width	Weight	Cube	Price
APTKBD0860	1/2"	58"	8"	60"	5	1	\$453
APTKBD0866	1/2"	64"	8"	66"	5	1	\$486
APTKBD0872	1/2"	70"	8"	72"	5	1	\$523

Fits APHSB hutch only. 2 Lower tackboards required on two-sided hutch. For fabric options, see page 163.

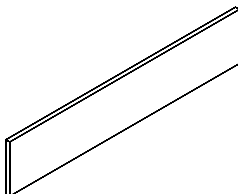

Tackboard (Upper) for Two Sided Hutch

Model#	Depth	Width	Height	Hutch Width	Weight	Cube	Price
APTKBD1530	1/2"	29"	14 3/8"	60"	4	1	\$423
APTKBD1533	1/2"	32"	14 3/8"	66"	5	1	\$445
APTKBD1536	1/2"	35"	14 3/8"	72"	5	1	\$476

Fits APHSB hutch only. 2 Upper tackboards required on two-sided hutch. For fabric options, see page 163.

Tackboards

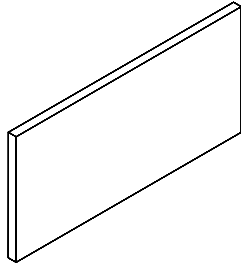

Tackboard (For 15"H TFM privacy screens)

Model#	Depth	Width	Height	Weight	Cube	Price
APTKBD1029	1/2"	28"	10"	3	1	\$406
APTKBD1035	1/2"	34"	10"	4	1	\$428
APTKBD1041	1/2"	40"	10"	4	1	\$536
APTKBD1047	1/2"	46"	10"	5	1	\$567
APTKBD1053	1/2"	52"	10"	5	1	\$580
15 APTKBD1059	1/2"	58"	10"	6	1	\$657
15 APTKBD1065	1/2"	64"	10"	6	1	\$703

For fabric options, refer to page 163.

Cushions

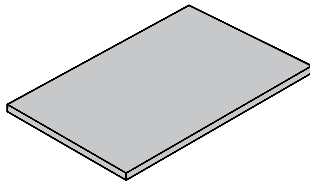

Cushion (Standard fabrics)

Model#	Depth	Width	Height	Fits Ped. Depth	Weight	Cube	Price
15 APCUH2016	19"	16"	1"	20"	4	1	\$330
15 APCUH2416	23"	16"	1"	24"	5	1	\$352
APCUH2030	19"	30"	1"	20"	7	1	\$375
APCUH2430	23"	30"	1"	24"	8	1	\$398
15 APCUH2036	19"	36"	1"	20"	8	1	\$413
15 APCUH2436	23"	36"	1"	24"	10	1	\$440

16"W for pedestal, 30"W & 36"W for credenza. Design to fit Apex pedestal only.
For fabric options, refer to page 163.

Wire Management

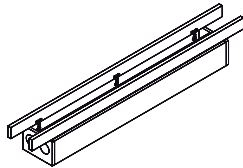

Middle Wire Management Trough with Hinged Doors

Model#	Depth	Width	Height	Weight	Cube	Price
APWMTM48	10"	36"	8"	47	3	\$789
APWMTM60	10"	48"	8"	58	3	\$940
APWMTM66	10"	54"	8"	63	4	\$1,049
APWMTM72	10"	60"	8"	69	4	\$1,178

* To be used between square panel bases. Grommet holes on left and right side.
Designed to fit shared worksurfaces only. Color combination N/A. Doors are same color as base.

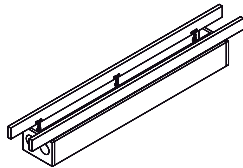

Outer Wire Management Trough with Hinged Doors

Model#	Depth	Width	Height	Weight	Cube	Price
APWMT048	10"	35"	8"	47	3	\$772
15 APWMT060	10"	47"	8"	58	3	\$922
APWMT066	10"	53"	8"	63	4	\$1,034
15 APWMT072	10"	59"	8"	69	4	\$1,162

* To be used between one metal support leg and one square panel base.
Grommet holes one side only. Designed to fit shared worksurfaces only.
Color combination N/A. Doors are same color as base.

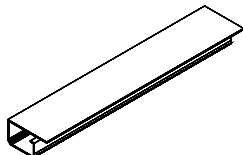

Plastic Wire Management Trough, Black

Model#	Depth	Width	Height	Weight	Cube	Price
APPWM12	2"	12"	1"	1	1	\$29
APPWM18	2"	18"	1"	1	1	\$29

Color: Black only. Field installed below worksurface with #8 x 1" wood screws (supplied).

apex series

Data/Power Management

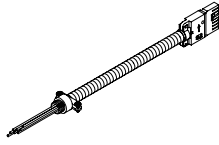

Electrical Starter Cable (8 Wire, 4 circuit)

Model#	Depth	Width	Height	Weight	Cube	Price
APESC72	1"	72"	1"	3	1	\$296

Must be connected to a building electrical supply by licensed electrician. (40) outlets maximum per single feed. (Available for freestanding trough).



Daisy Chain Electrical Cable

Model#	Depth	Width	Height	Fits Trough	Weight	Cube	Price
APDCE24	1"	24"	1"		2	1	\$209
APDCE36	1"	28"	1"		2	1	\$241
APDCE48	1"	40"	1"	48"	2	1	\$266
APDCE54	1"	46"	1"		2	1	\$296
APDCE60	1"	52"	1"	54"	3	1	\$296
APDCE66	1"	58"	1"	66"	3	1	\$317
APDCE72	1"	64"	1"	72"	3	1	\$328

Daisy chain available for freestanding trough



Split Cable (8 Wire, 4 circuit)

Model#	Depth	Width	Height	Color	Weight	Cube	Price
APSFC12	1"	12"	1"	Metal	1	1	\$196

Used to split into two directions as a "Y" coupler.



Single-Sided Power Box (4 Power outlets)

Model#	Depth	Width	Height	Weight	Cube	Price
APSSPB4	1 1/4"	9 5/16"	2 1/4"	1	1	\$231

Can be mounted below worksurfaces or in wire management troughs. Includes (1) circuit 1, (1) circuit 2, (1) circuit IG, (1) circuit 4. (Available for freestanding trough)

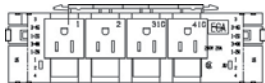

Double-Sided Power Box (8 Power outlets)

Model#	Depth	Width	Height	Weight	Cube	Price
APSSPB8	2"	8 7/16"	2 1/2"	1	1	\$380

Can be mounted below worksurfaces only. Includes (2) circuit 1, (2) circuit 2, (2) circuit IG, (2) circuit 4. (1) mounting bracket MB

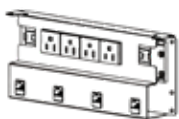
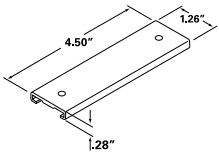

AP SBS4

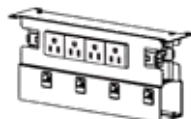

AP SBD8

Power Module Single and Double Sided Data Ready Units

Model#	Depth	Width	Height	Color	Weight	Cube	Price
AP SBS4	1 5/8"	10 1/2"	4 1/2"	Silver	1	1	\$1,125
AP SBD8	2 1/2"	10 1/2"	4 1/2"	Silver	1	1	\$1,251

No cut-out required. Field install under worksurface or onto a Modesty Panel. Mount hardware included. Date Hardwire Jack CAT 6. Black with Orange Bezel. AP SBS4: 4 power outlets and 4 RJ45. AP SBD8: 8 power outlets and 4 RJ45 (4 blank caps).

Spine Wire Management

Model#	Depth	Width	Height	Weight	Cube	Price
AP SWM	1 3/8"	2 1/2"	28"	1	1	\$274

Wire management from floor to underside of work surface (Field installed). Finish: Silver. (Available for freestanding trough).



Rectangular Power Grommet (1 Power, 2 Power USB with adapter, 108" cord)

Model#	Depth	Width	Height	Color	Weight	Cube	Price
AP R PG1B	2 1/4"	3 3/4"	3"	Black	2	1	\$588
AP R PG1S	2 1/4"	3 3/4"	3"	Silver	2	1	\$588
AP R PG1GW	2 1/4"	3 3/4"	3"	Gloss White	2	1	\$588



apex freestanding troughs



NOTE: Freestanding Troughs Mix Color Option is N/A.

apex series

Trough with Center Panel

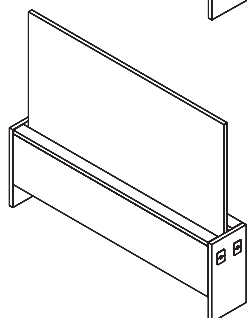
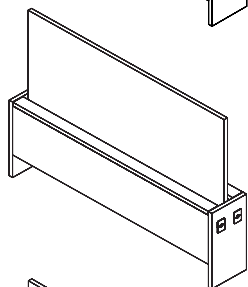
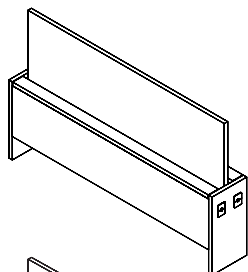
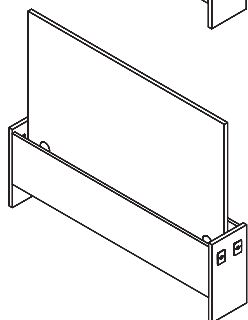
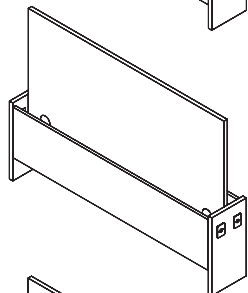
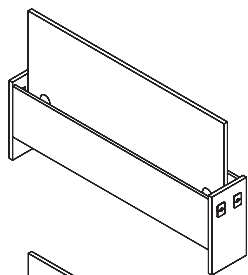

Trough No Doors with Center Panel, 36"H

Model#	Depth	Width	Height	Price
APWMT4836ND	10"	48"	20/36"	\$902
APWMT5436ND	10"	54"	20/36"	\$942
APWMT6036ND	10"	60"	20/36"	\$986
APWMT6636ND	10"	66"	20/36"	\$1,026
APWMT7236ND	10"	72"	20/36"	\$1,073

Silver Square Grommet: 2 left & right end panel, 6 grommet holes inside trough.

Trough No Doors with Center Panel, 42"H

Model#	Depth	Width	Height	Price
APWMT4842ND	10"	48"	20/42"	\$935
APWMT5442ND	10"	54"	20/42"	\$983
APWMT6042ND	10"	60"	20/42"	\$1,026
APWMT6642ND	10"	66"	20/42"	\$1,073
APWMT7242ND	10"	72"	20/42"	\$1,120

Silver Square Grommet: 2 left & right end panel, 6 grommet holes inside trough.

Trough No Doors with Center Panel, 48"H

Model#	Depth	Width	Height	Price
APWMT4848ND	10"	48"	20/48"	\$967
APWMT5448ND	10"	54"	20/48"	\$1,018
APWMT6048ND	10"	60"	20/48"	\$1,064
APWMT6648ND	10"	66"	20/48"	\$1,115
APWMT7248ND	10"	72"	20/48"	\$1,167

Silver Square Grommet: 2 left & right end panel, 6 grommet holes inside trough.

Trough with Doors & Center Panel

Trough with Hinged Doors and Center Panel, 36"H

Model#	Depth	Width	Height	Price
APWMT4836WD	10"	48"	20/36"	\$1,234
APWMT5436WD	10"	54"	20/36"	\$1,285
APWMT6036WD	10"	60"	20/36"	\$1,336
APWMT6636WD	10"	66"	20/36"	\$1,384
APWMT7236WD	10"	72"	20/36"	\$1,433

Silver Square Grommet: 2 left & right end panel, 6 grommet holes inside trough.

Trough with Hinged Doors and Center Panel, 42"H

Model#	Depth	Width	Height	Price
APWMT4842WD	10"	48"	20/42"	\$1,266
APWMT5442WD	10"	54"	20/42"	\$1,322
APWMT6042WD	10"	60"	20/42"	\$1,372
APWMT6642WD	10"	66"	20/42"	\$1,429
APWMT7242WD	10"	72"	20/42"	\$1,481

Silver Square Grommet: 2 left & right end panel, 6 grommet holes inside trough.

Trough with Hinged Doors and Center Panel, 48"H

Model#	Depth	Width	Height	Price
APWMT4848WD	10"	48"	20/48"	\$1,301
APWMT5448WD	10"	54"	20/48"	\$1,359
APWMT6048WD	10"	60"	20/48"	\$1,415
APWMT6648WD	10"	66"	20/48"	\$1,470
APWMT7248WD	10"	72"	20/48"	\$1,531

Silver Square Grommet: 2 left & right end panel, 6 grommet holes inside trough.

apex series

Trough with Center Panel & End Panel

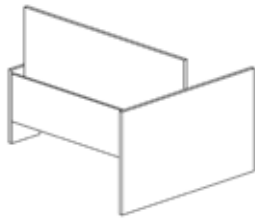

Trough No Doors with Center Panel and 48"W End Panel, 36"H

Model#	Depth	Width	Height	Price
APWMT4836ND48	10"	48"	20/36"	\$1,154
APWMT5436ND48	10"	54"	20/36"	\$1,195
APWMT6036ND48	10"	60"	20/36"	\$1,237
APWMT6636ND48	10"	66"	20/36"	\$1,278
APWMT7236ND48	10"	72"	20/36"	\$1,324

48"W end panel is 28"H. Silver square grommet: 2 on 20"H end panel, 6 grommet holes inside trough.

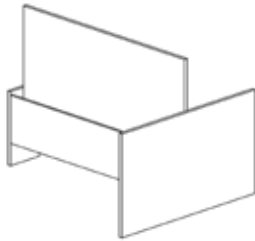

Trough No Doors with Center Panel and 48"W End Panel, 42"H

Model#	Depth	Width	Height	Price
APWMT4842ND48	10"	48"	20/42"	\$1,187
APWMT5442ND48	10"	54"	20/42"	\$1,233
APWMT6042ND48	10"	60"	20/42"	\$1,278
APWMT6642ND48	10"	66"	20/42"	\$1,324
APWMT7242ND48	10"	72"	20/42"	\$1,371

48"W end panel is 28"H. Silver square grommet: 2 on 20"H end panel, 6 grommet holes inside trough.

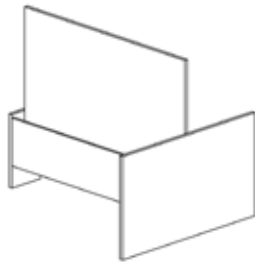

Trough No Doors with Center Panel and 48"W End Panel, 48"H

Model#	Depth	Width	Height	Price
APWMT4848ND48	10"	48"	20/48"	\$1,217
APWMT5448ND48	10"	54"	20/48"	\$1,270
APWMT6048ND48	10"	60"	20/48"	\$1,317
APWMT6648ND48	10"	66"	20/48"	\$1,368
APWMT7248ND48	10"	72"	20/48"	\$1,418

48"W end panel is 28"H. Silver square grommet: 2 on 20"H end panel, 6 grommet holes inside trough.

Trough with Doors, Center Panel & End Panel

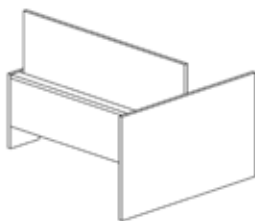

Trough with Hinged Doors Center Panel and 48"W End Panel, 36"H

Model#	Depth	Width	Height	Price
APWMT4836WD48	10"	48"	20/36"	\$1,487
APWMT5436WD48	10"	54"	20/36"	\$1,537
APWMT6036WD48	10"	60"	20/36"	\$1,590
APWMT6636WD48	10"	66"	20/36"	\$1,636
APWMT7236WD48	10"	72"	20/36"	\$1,686

48"W end panel is 28"H. Silver square grommet: 2 on 20"H end panel, 6 grommet holes inside trough.

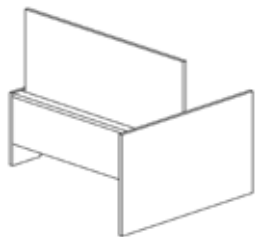

Trough with Hinged Doors Center Panel and 48"W End Panel, 42"H

Model#	Depth	Width	Height	Price
APWMT4842WD48	10"	48"	20/42"	\$1,520
APWMT5442WD48	10"	54"	20/42"	\$1,575
APWMT6042WD48	10"	60"	20/42"	\$1,626
APWMT6642WD48	10"	66"	20/42"	\$1,681
APWMT7242WD48	10"	72"	20/42"	\$1,733

48"W end panel is 28"H. Silver square grommet: 2 on 20"H end panel, 6 grommet holes inside trough.

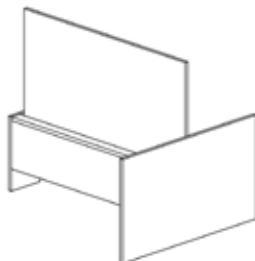

Trough with Hinged Doors Center Panel and 48"W End Panel, 48"H

Model#	Depth	Width	Height	Price
APWMT4848WD48	10"	48"	20/48"	\$1,552
APWMT5448WD48	10"	54"	20/48"	\$1,616
APWMT6048WD48	10"	60"	20/48"	\$1,668
APWMT6648WD48	10"	66"	20/48"	\$1,722
APWMT7248WD48	10"	72"	20/48"	\$1,782

48"W end panel is 28"H. Silver square grommet: 2 on 20"H end panel, 6 grommet holes inside trough.

apex series

Trough with Center Panel & End Panel

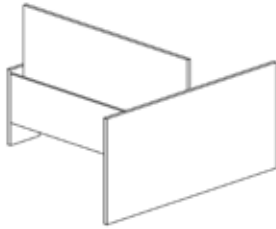

Trough No Doors with Center Panel and 60"W End Panel, 36"H

Model#	Depth	Width	Height	Price
APWMT4836ND60	10"	48"	20/36"	\$1,204
APWMT5436ND60	10"	54"	20/36"	\$1,245
APWMT6036ND60	10"	60"	20/36"	\$1,288
APWMT6636ND60	10"	66"	20/36"	\$1,326
APWMT7236ND60	10"	72"	20/36"	\$1,373

60"W end panel is 28"H. Silver square grommet: 2 on 20"H end panel, 6 grommet holes inside trough.

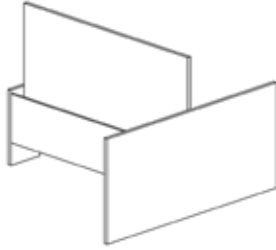

Trough No Doors with Center Panel and 60"W End Panel, 42"H

Model#	Depth	Width	Height	Price
APWMT4842ND60	10"	48"	20/42"	\$1,236
APWMT5442ND60	10"	54"	20/42"	\$1,281
APWMT6042ND60	10"	60"	20/42"	\$1,326
APWMT6642ND60	10"	66"	20/42"	\$1,373
APWMT7242ND60	10"	72"	20/42"	\$1,421

60"W end panel is 28"H. Silver square grommet: 2 on 20"H end panel, 6 grommet holes inside trough.

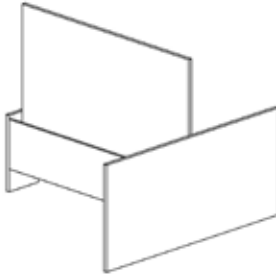

Trough No Doors with Center Panel and 60"W End Panel, 48"H

Model#	Depth	Width	Height	Price
APWMT4848ND60	10"	48"	20/48"	\$1,269
APWMT5448ND60	10"	54"	20/48"	\$1,319
APWMT6048ND60	10"	60"	20/48"	\$1,364
APWMT6648ND60	10"	66"	20/48"	\$1,416
APWMT7248ND60	10"	72"	20/48"	\$1,466

60"W end panel is 28"H. Silver square grommet: 2 on 20"H end panel, 6 grommet holes inside trough.

Trough with Doors, Center Panel & End Panel

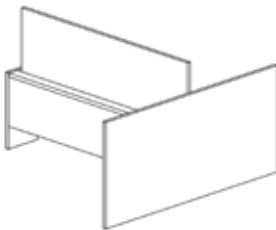

Trough with Hinged Doors Center Panel and 60"W End Panel, 36"H

Model#	Depth	Width	Height	Price
APWMT4836WD60	10"	48"	20/36"	\$1,535
APWMT5436WD60	10"	54"	20/36"	\$1,588
APWMT6036WD60	10"	60"	20/36"	\$1,638
APWMT6636WD60	10"	66"	20/36"	\$1,685
APWMT7236WD60	10"	72"	20/36"	\$1,736

60"W end panel is 28"H. Silver square grommet: 2 on 20"H end panel, 6 grommet holes inside trough.

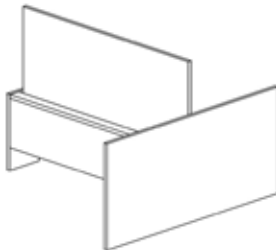

Trough with Hinged Doors Center Panel and 60"W End Panel, 42"H

Model#	Depth	Width	Height	Price
APWMT4842WD60	10"	48"	20/42"	\$1,568
APWMT5442WD60	10"	54"	20/42"	\$1,623
APWMT6042WD60	10"	60"	20/42"	\$1,674
APWMT6642WD60	10"	66"	20/42"	\$1,730
APWMT7242WD60	10"	72"	20/42"	\$1,780

60"W end panel is 28"H. Silver square grommet: 2 on 20"H end panel, 6 grommet holes inside trough.

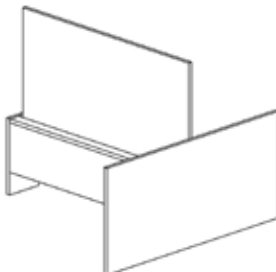

Trough with Hinged Doors Center Panel and 60"W End Panel, 48"H

Model#	Depth	Width	Height	Price
APWMT4848WD60	10"	48"	20/48"	\$1,601
APWMT5448WD60	10"	54"	20/48"	\$1,664
APWMT6048WD60	10"	60"	20/48"	\$1,716
APWMT6648WD60	10"	66"	20/48"	\$1,773
APWMT7248WD60	10"	72"	20/48"	\$1,831

60"W end panel is 28"H. Silver square grommet: 2 on 20"H end panel, 6 grommet holes inside trough.

Trough with Center Panel & Privacy Screen (Privacy Screen Adds 12"H to Height)

Trough No Doors with Center Panel & Frosted Acrylic Screen, 36"H

Model#	Depth	Width	Height	Privacy Screen	Price
APWMT4836NDPS	10"	48"	20/36"	APPSU48	\$1,448
APWMT5436NDPS	10"	54"	20/36"	APPSU54	\$1,724
APWMT6036NDPS	10"	60"	20/36"	APPSU60	\$1,774
APWMT6636NDPS	10"	66"	20/36"	APPSU66	\$1,822
APWMT7236NDPS	10"	72"	20/36"	APPSU72	\$1,873

Silver Square Grommet: 2 left & right end panel, 6 grommet holes inside trough.

Trough with Hinged Doors, Center Panel & Frosted Acrylic Screen, 36"H

Model#	Depth	Width	Height	Privacy Screen	Price
APWMT4836WDPS	10"	48"	20/36"	APPSU48	\$1,779
APWMT5436WDPS	10"	54"	20/36"	APPSU54	\$2,066
APWMT6036WDPS	10"	60"	20/36"	APPSU60	\$2,123
APWMT6636WDPS	10"	66"	20/36"	APPSU66	\$2,180
APWMT7236WDPS	10"	72"	20/36"	APPSU72	\$2,231

Silver Square Grommet: 2 left & right end panel, 6 grommet holes inside trough.

Trough with Center Panel, Privacy Screen & End Panel (Privacy Screen Adds 12"H to Height)

Trough No Doors with Center Panel, 48"W End Panel & Frosted Acrylic Screen, 36"H

Model#	Depth	Width	Height	Privacy Screen	Price
APWMT4836ND48PS	10"	48"	20/36"	APPSU48	\$1,700
APWMT5436ND48PS	10"	54"	20/36"	APPSU54	\$1,975
APWMT6036ND48PS	10"	60"	20/36"	APPSU60	\$2,026
APWMT6636ND48PS	10"	66"	20/36"	APPSU66	\$2,074
APWMT7236ND48PS	10"	72"	20/36"	APPSU72	\$2,129

48"W end panel is 28"H. Silver Square Grommet: 2 on 20"H end panel, 6 grommet holes inside trough.

Trough No Doors with Center Panel, 60"W End Panel & Frosted Acrylic Screen, 36"H

Model#	Depth	Width	Height	Privacy Screen	Price
APWMT4836ND60PS	10"	48"	20/36"	APPSU48	\$1,748
APWMT5436ND60PS	10"	54"	20/36"	APPSU54	\$2,026
APWMT6036ND60PS	10"	60"	20/36"	APPSU60	\$2,075
APWMT6636ND60PS	10"	66"	20/36"	APPSU66	\$2,122
APWMT7236ND60PS	10"	72"	20/36"	APPSU72	\$2,178

48"W end panel is 28"H. Silver Square Grommet: 2 on 20"H end panel, 6 grommet holes inside trough.

Trough w/ Hinged Doors Center Panel, 48"W End Panel & Frosted Acrylic Screen, 36"H

Model#	Depth	Width	Height	Privacy Screen	Price
APWMT4836WD48PS	10"	48"	20/36"	APPSU48	\$2,032
APWMT5436WD48PS	10"	54"	20/36"	APPSU54	\$2,320
APWMT6036WD48PS	10"	60"	20/36"	APPSU60	\$2,378
APWMT6636WD48PS	10"	66"	20/36"	APPSU66	\$2,430
APWMT7236WD48PS	10"	72"	20/36"	APPSU72	\$2,489

48"W end panel is 28"H. Silver Square Grommet: 2 on 20"H end panel, 6 grommet holes inside trough.

Trough w/ Hinged Doors Center Panel, 60"W End Panel & Frosted Acrylic Screen, 36"H

Model#	Depth	Width	Height	Privacy Screen	Price
APWMT4836WD60PS	10"	48"	20/36"	APPSU48	\$2,082
APWMT5436WD60PS	10"	54"	20/36"	APPSU54	\$2,368
APWMT6036WD60PS	10"	60"	20/36"	APPSU60	\$2,427
APWMT6636WD60PS	10"	66"	20/36"	APPSU66	\$2,479
APWMT7236WD60PS	10"	72"	20/36"	APPSU72	\$2,539

60"W end panel is 28"H. Silver Square Grommet: 2 on 20"H end panel, 6 grommet holes inside trough.

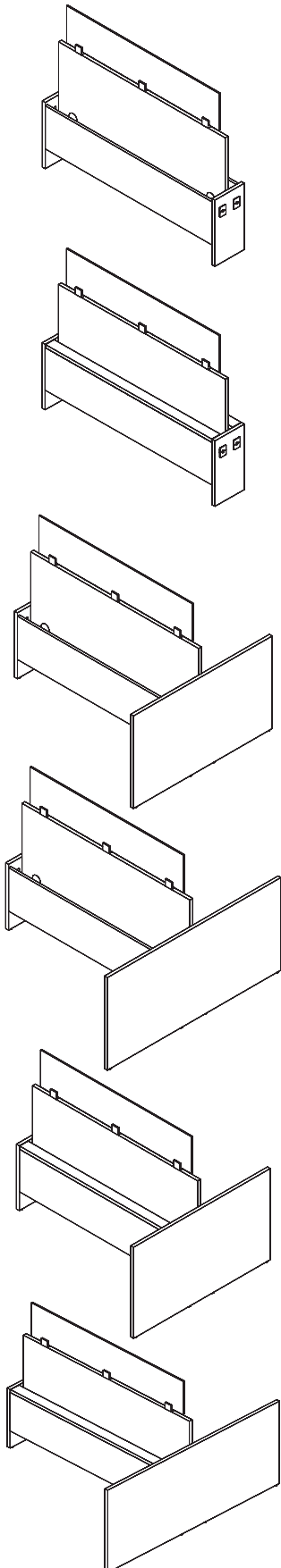

Worksurfaces for Freestanding Troughs (For Freestanding Troughs)

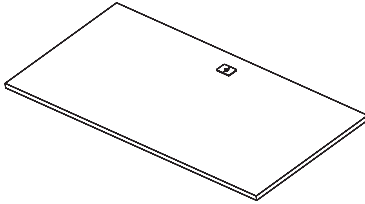

Rectangular Worksurfaces, Square Silver Grommet

Model#	Depth	Width	Height	Trough Width	Price
APRT2447	24"	47"	1"	48"	\$333
APRT2453	24"	53"	1"	54"	\$422
APRT2459	24"	59"	1"	60"	\$441
APRT2465	24"	65"	1"	66"	\$472
APRT2471	24"	71"	1"	72"	\$495
APRT3047	30"	47"	1"	48"	\$365
APRT3053	30"	53"	1"	54"	\$472
APRT3059	30"	59"	1"	60"	\$486
APRT3065	30"	65"	1"	66"	\$525
APRT3071	30"	71"	1"	72"	\$552

Center silver square grommet standard. Tops are designed to fit freestanding troughs.

Adjustable Bases (For Worksurfaces)

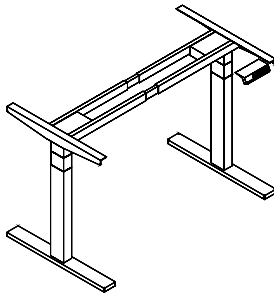

Adjustable Height Electrical Base

Model#	Base (D)	Base (W)	Height	Fits Top Size	Color	Weight	Cube	Price
MMLEGAHE24S3	22"	47-72"	23 ½-49"	24"D-72"W	Silver	66	1	\$1,498
MMLEGAHE24B3	22"	47-72"	23 ½-49"	24"D-72"W	Black	66	1	\$1,498
MMLEGAHE24W3	22"	47-72"	23 ½-49"	24"D-72"W	White	66	1	\$1,498
MMLEGAHE30S3	28"	47-72"	23 ½-49"	30"D-72"W	Silver	66	1	\$1,498
MMLEGAHE30B3	28"	47-72"	23 ½-49"	30"D-72"W	Black	66	1	\$1,498
MMLEGAHE30W3	28"	47-72"	23 ½-49"	30"D-72"W	White	66	1	\$1,498

3 Stage base.

Tackboards (For Freestanding Trough Center Panels)

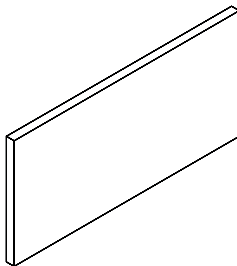

Tackboard (For 42"H & 48"H troughs)

Model#	Depth	Width	Height	Fits Trough Width	Price
APTKBD1948	½"	46"	19"	48"W	\$590
APTKBD1954	½"	52"	19"	54"W	\$605
APTKBD1960	½"	58"	19"	60"W	\$683
APTKBD1966	½"	64"	19"	66"W	\$733
APTKBD1972	½"	70"	19"	72"W	\$781

For tackboard fabric options, see page 163. Tackboards N/A for 36"H troughs.

handle options



APH1
Smooth, curved edge handle in brushed aluminum

data/power management



APSSPB4/ APSSPB8
Single sided power box with four power outlets/
Double sided power box with eight power outlets



APESC72
System hardwire electrical
starter cable



APDCE
Daisy chain electrical cable



APSFC12
Split Cable



APRPG1
Rectangular Power Grommet



APSWM
Spine Wire Management

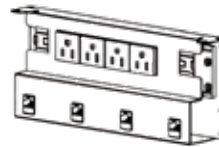

APBSB4
Power Module Single Sided
Data Ready

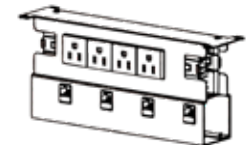

APSB8
Power Module Double Sided
Data Ready

grommet options



APRG1S
Standard Square Grommet - Silver



APRG1B
Standard Square Grommet - Black

apex series TFM color options

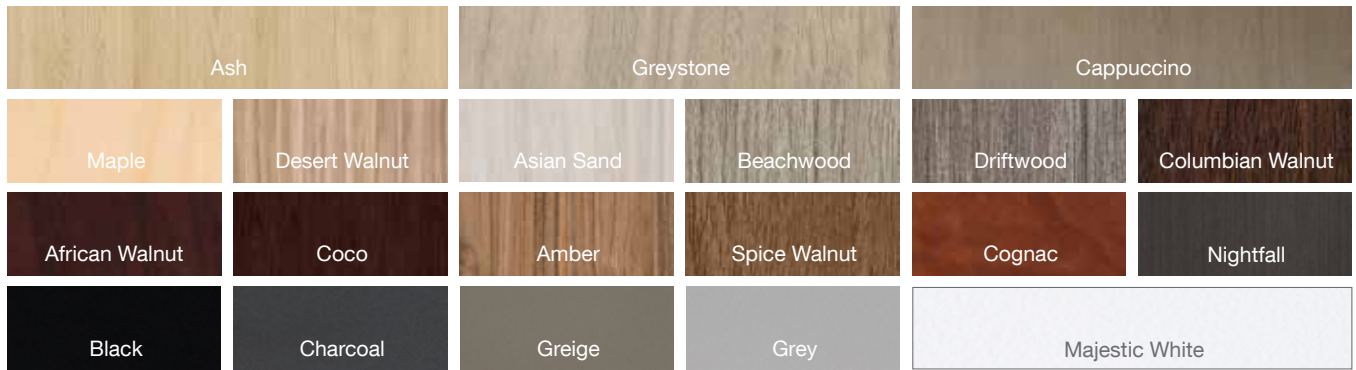

HPL color options (For HPL Modesty & HPL Privacy Screens)



metal leg color options

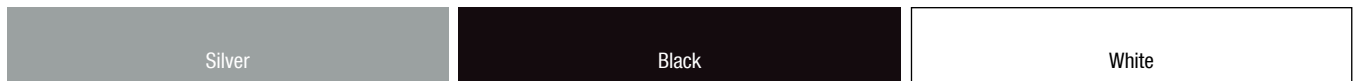

tackboard fabric options

Anchorage 2335



Cape Cod 3073

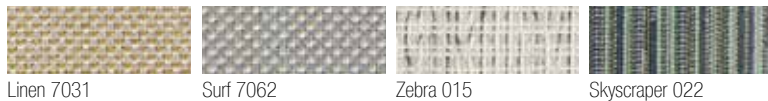

Tempest 2120 Metro 3077

Metallation 5118



Sprite 2671

Phrase 9508



Laminate finishes & fabric samples shown are approximations. Colors may vary between factories. TFM & HPL laminate finishes will vary. For sample requests, email Maverick West: orderentry@maverickdesk.com. Maverick East: mveorders@maverickdesk.com

For actual fabric samples, go to: guilfordofmaine.com/swatches

Note: Renderings & line drawings shown are a resemblance to finished product. Product designs may vary. Discounts are different between factories. Two standard colors may be specified at no charge. For three color combinations, email for quote.